

NEFF
cook. create. inspire.



*The NEFF
APPLIANCES RANGE 2026*



Introduction to NEFF

Cook. Create. Inspire

At NEFF we believe that the kitchen is the heart of every home. A place to eat, meet and get creative with your cooking. With an extensive range of innovative appliances, we're constantly working to meet the demands of every lifestyle. From our unique Slide & Hide® disappearing oven door, to our extensive range of steam and pyrolytic ovens, hobs and hoods, these appliances expertly installed create the perfect NEFF Kitchen.

Contents

OVENS	4-107	VENTILATION	162-209
Why NEFF?	4-5	Introduction to Hoods	162-163
NEFF's Iconic Slide & Hide Door	6-7	Your Guide to Control Types	164
Steam Cooking Explained	8-9	Key Functions Guide	165
Accessible & Multigenerational Kitchens	10-11	Installation Options	166-167
NEFF Home Connect	12-13	NEFF Hob to Hood Connectivity	168-169
NEFF is Here With You Every Step of the Way	14-15	Introduction to Flex Hoods	170-171
Introduction to Ovens	16-17	Your Guide to Single and Combination Flex Design	172-173
NEFF Oven Range 2026	18-19	Island Ventilation Solutions	174-175
Oven Feature Overview	20-21	Island Specification	176-183
Key Functions Guide	22-23	Wall Mounted Ventilation Solutions	184-185
Core Oven Range		Wall Mounted Ventilation Specification	186-189
N90 and N70 Range of Appliances	24-25	Integrated Furniture Ventilation Solutions	190-191
N50 Range of Appliances	26-27	Integrated Furniture Ventilation Specification	192-195
Product Specification	28-41	Hoods Appliance List	196-197
Seamless Combination®	42-43	Product Line Drawings	198-209
Product Line Drawings	44-53	COOLING	210-243
N90/N70 Graphite Grey Appliance List	54-55	Introduction to Cooling	210-211
N50 Appliance List	56	Built-In Fridge Freezer Guide	212-213
Optional Accessories List	57	Built-In Single Fridge Freezer Guide	214-215
Flex Design Ovens		Other Styles Guide	216
Open for Flexibility	58-59	Key Functions Guide	217
Open for Personalised Style	60-61	Design Features	218-221
Flex Design Range of Appliances	62-63	Product Specification	222-235
Product Specification	64-69	Product Line Drawings	236-243
How to Order with Flex Design	70-71	DISHWASHERS	244-255
The Way the Concept Works - Single Appliance	72	Introduction to Dishwashers	244
The Way the Concept Works - Multiple Appliances	73	Dishwasher Solutions	245
The Seamless Combination Family	74-75	Range at a Glance	246-247
Your Guide to Ordering a Single Flex Appliance	76-77	Key Functions Guide	248-249
Your Guide to Cooking Combination Flex Design	78-95	Product Specification	250-254
Product Line Drawings	96-105	Product Line Drawings	255
Flex Appliance List	106-107	LAUNDRY	256-261
HOBS	108-161	Introduction to Laundry	256
Introduction to Hobs	108-109	Key Functions Guide	257
Your Guide to Hobs	110-111	Product Specification	258-259
Introduction to Electric Hobs	112-115	Product Line Drawings	260-261
Guide to Electric Hobs	116-117	NEFF CUSTOMER SERVICE	262-263
Hobs Range	118-119		
Your Guide to Single Appliance Flex Design	120-121		
Your Guide to Seamless Combination Flex Design	122-123		
Flex Design Venting Hobs Product Specification	124-125		
Venting Hobs Product Specification	126-127		
Venting Hobs Installation Options	128-129		
Venting Hobs Product Line Drawings	130-131		
Venting Hob Installation Options and Accessories	132		
Venting Hob Ducting Components	133		
Flex Induction Hobs	134-137		
Induction Hobs	138-139		
Ceramic Hobs	140		
Induction Cookwear Accessory Range	140-141		
Electric Hobs Line Drawings	142-143		
Electric Hobs Accessories and Saucepans	144-145		
Introduction to Gas Hob	146-149		
Guide to Gas Hobs	150-151		
Gas Hobs Specification	152-157		
Gas Hobs Line Drawings	158		
Flex Design Hobs List	159		
Electric Hobs List	160		
Gas Hobs List	161		

Appliances to spark every cook's CREATIVITY

Built-in appliances that let passionate cooks express their individuality

As a leader in built-in appliances, we design precision-engineered, beautifully finished products that give home chefs the freedom to create a kitchen that reflects their taste and cooking style. Combining professional performance, seamless integration and customisable options, our range empowers people who love to cook to personalise every detail – from look to function – so their kitchen is as individual as their recipes.



A NEFF icon: Slide & Hide®

NEFF Slide & Hide® the first and only fully retracting oven door that disappears under the oven cavity to give unobstructed access to trays and pans. It combines smart, user-focused engineering with stylish German design: easy, safe handling, flexible cooking across styles and budgets, and seamless integration into a range of kitchen layouts.

NEFF is here for you every step of the way

NEFF positions itself as a brand that protects your purchase through meaningful warranties, reliable repair and parts services, highly rated customer care, and an engaged owner community.

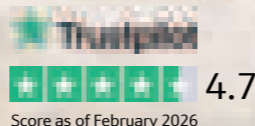
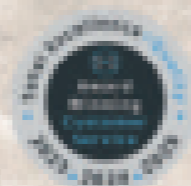

Enhance your cooking with steam

Steam cooking preserves flavour, moisture and nutrients while often shortening cooking time, keeping vegetables vibrant and meats tender. It's versatile: gentle steam suits delicate foods and reheating; full steam cooks larger items quickly and helps retain vitamins; steam boosts improve oven spring and crust for breads. Other steam modes refresh food and prove dough for healthier, better baking.

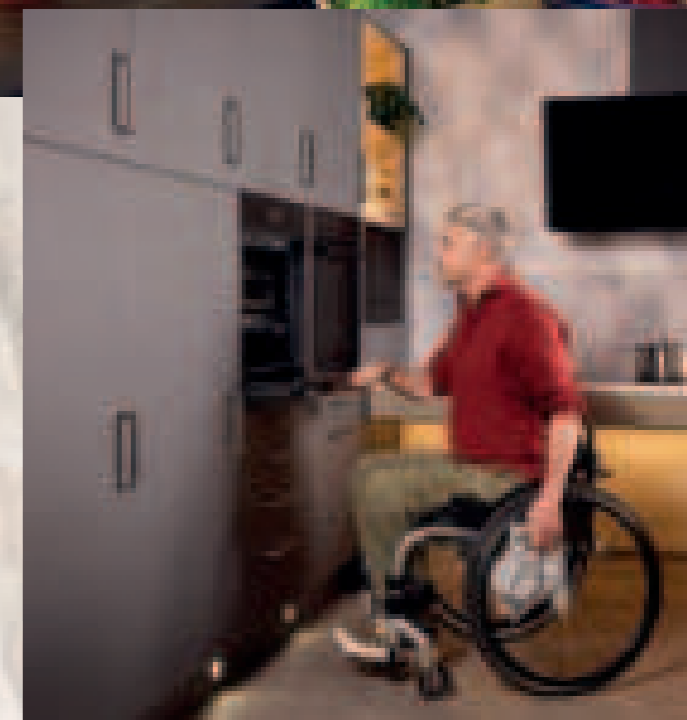

Create a kitchen for every need

Our range of thoughtfully engineered appliances helps every cook get the best from their kitchen. Innovations like the Slide & Hide® oven give wheelchair users easier access for loading and checking dishes. NEFF Home Connect and smart features (remote, app and voice control) lets users operate appliances remotely. From induction hobs with built-in extraction to connected refrigeration, these appliances make cooking easier and more inclusive.

NEFF's iconic SLIDE & HIDE® DOOR



The iconic Slide & Hide®: the first and only fully retracting oven door. Only from NEFF.

What makes our Slide & Hide® ovens so special:

- Wide range of features suited to all cooking styles.
- Seals the food quickly making it ideal for multi-level cooking. A perfect choice for baking and roasting achieving succulent roasts and even bakes.
- The range includes an oven for every cooking style and budget. Designed using a value class to identify each collection.
 - Our N90 range is our most premium range followed by N70 and N50
 - For perfect design alignment the ranges have been curated to be installed vertically or horizontally within their own value class aligning and matching their fascia panels.
- Our Single Slide & Hide® ovens seamlessly integrate into various kitchen designs. They can be combined with other Single ovens side by side or with Compact ovens and warming drawers, both horizontally and vertically, offering versatility in design and cooking solutions.
 - One notable advantage is in an Accessible kitchen, where these appliances offer many benefits. They can be installed at a suitable height, and the retractable door provides full, safe access to the oven cavity.
- German design.

Steam cooking EXPLAINED

WHAT IS IT

VARIO STEAM®	INTENSIVE STEAM
Vario Steam® combines conventional hot air cooking functions with Steam.	Intensive Steam has all the functions of Vario Steam® combining hot air and steam.
Ducts in the back plate release steam into the oven quickly and evenly adding steam into the oven cavity.	It also uses 100% (pure) steam to gently cook a variety of dishes.
Vario Steam® has 3 levels of steam: <ul style="list-style-type: none"> • Level 1 (Low) Steam • Level 2 (Medium) Steam • Level 3 (High) Steam 	The Intensive Steam now means that the steam temperature will reach 120°C – by increasing the temperature it reduces the cooking times for certain foods.
Both steam approaches can be added to: <ul style="list-style-type: none"> • Circo Therm® • Top and Bottom Heat • Circo Roasting • Bread Baking Setting 	



Vario Steam® & Steam Boost

The difference between these two features is that with Vario Steam®, once the level of steam intensity is selected, the appliance automatically adds in the steam at selected intervals whereas with Steam Boost the steam is manually added by the user for a 3 minute duration, repeatable for up to another 9 times.

Vario Steam®

Vario Steam® has 3 levels suitable for:

- **Add Level 1 steam for pastries and cakes** - to give an even golden crust, better rise and volume. No soggy cakes here just beautifully moist.
- **Perfect roasted meats can be achieved by adding level 2 steam**, no basting, just a golden crisp skin with tender meat inside. Plus less shrinkage.
- **Add level 3 high steam to Circo Roasting 200°C** for easy **roasties**. No part boiling, a touch of olive oil for crisp and fluffy results.

Steam Boost

This feature is primarily for home-baked bread, giving a crisp outside and nice and fluffy on the inside:

- It delivers fast and intensive steam
- Oven is pre-heated
- A bread baking stone can be used
- Once to temperature press the Steam Boost* button to inject 3 mins of steam.
- This can be done up to 10 times during the programme.

* The feature is called Steam Boost but on the appliance fascia this is Steam Jet.



Intensive Steam (Full Steam)

Increasing the temperature reduces cooking times for produce that cooks more slowly, such as root vegetables, rice dishes and pulses. Cooking these food types more quickly has the added benefit of retaining more vitamins.

Key Benefits

- **Saves Time** – increasing to 120°C means it can reduce cooking times.
- **Healthier Way to cook** – more vitamins and nutrients retained due to quicker cooking time.
- **Defrost** – this programme introduces steam to the cavity to ensure frozen food does not dry out. Temperature range 30-60°C.

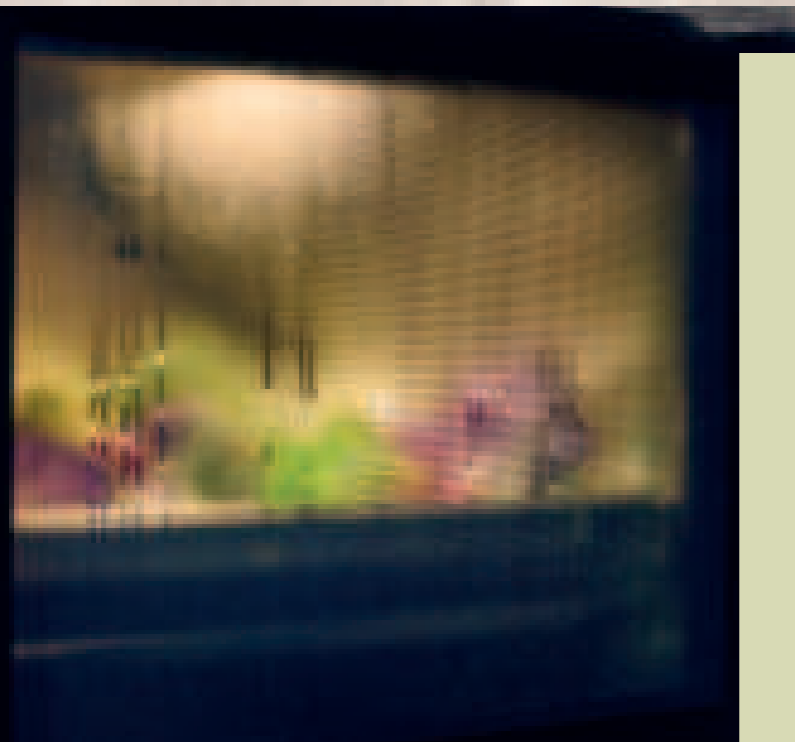

Other Steam Options

Steam Reheat

The steam-reheat function adds water vapour and gentle heat during reheating so food retains moisture and texture and tastes closer to freshly cooked. Unlike a microwave, which can dry food out or make textures uneven, steam-reheat keeps food juicy and preserves crispness – even bread can regain its crust – making it ideal for batch-cooked and ready meals. Temperature range: 80-180°C.

Dough Proving

Bread will prove quicker using this function than at room temperature. Temperature range 30-50°C.



Create a kitchen for your EVERY NEED

At NEFF, we pride ourselves on helping our customers achieve the best results in their kitchens.

Our appliances are designed to make a difference and enhance home cooking. With our broad appeal and unique features like Slide & Hide® ovens, which offer full access and cater to various needs, including wheelchair users, we aim to provide a solution for all cooks and kitchens.



To find out more about how NEFF helps make kitchens inclusive for everyone, scan here.



Innovation that makes your life easier

NEFF's Built-In Range includes options such as Induction hobs with Twist Pad® control, smart connectivity for hobs and hoods, and touch-to-open refrigeration and dishwashers.

NEFF enables everyone to maximise their cooking potential

By incorporating NEFF appliances into specially designed kitchen furniture, we support safe and independent living for individuals with specific needs. Accessible kitchens, with features like rise and fall worktops, benefit not only wheelchair users but also those in multi-generational homes, accommodating different cooking and preparation preferences. The NEFF range installed in Symphony's Freedom Kitchen demonstrates a collaboration for Accessible & Multigenerational kitchens. The images taken at the NEFF Showroom in Corby highlight how these two can work together.



Tactile markers for ease of use

Tactile markers on the hob help visually impaired users quickly and confidently locate cooking zones and controls, supporting independent use.

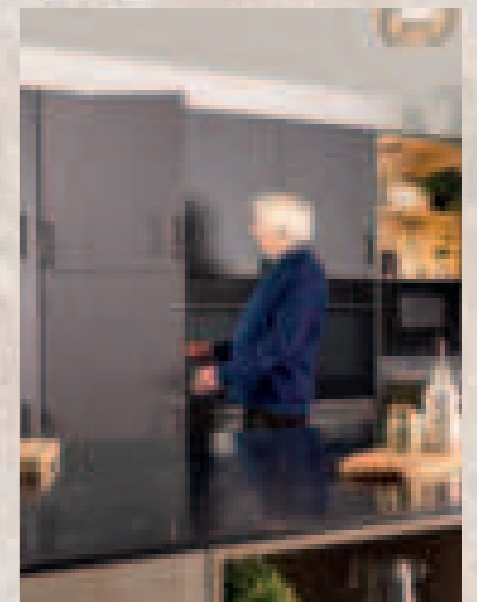

For fully integrated fridges, Door Open Assist lets a light nudge break the seal so heavy cabinet doors open easily.

Get more with NEFF HOME CONNECT

More time for your creativity and your guests.

Connections are important for NEFF and the connections that we make over food are our favourite ones. When we share a meal with family and friends, we share a connection around the table but sometimes we all need a little help. When you're in need of a little creative inspiration, having a partner in the kitchen can make those connections easier and stress free...



Home Connect

Perfect Partners

With food it's not always about the refined presentation – it's about the flavour, the joy and the pleasure those shared meals bring. Stay better connected with your guests with oven control and monitoring via smartphone or voice control. No more dashing back and forth to the kitchen – enjoy the benefits of our technology partnerships for perfect cooking results every time!

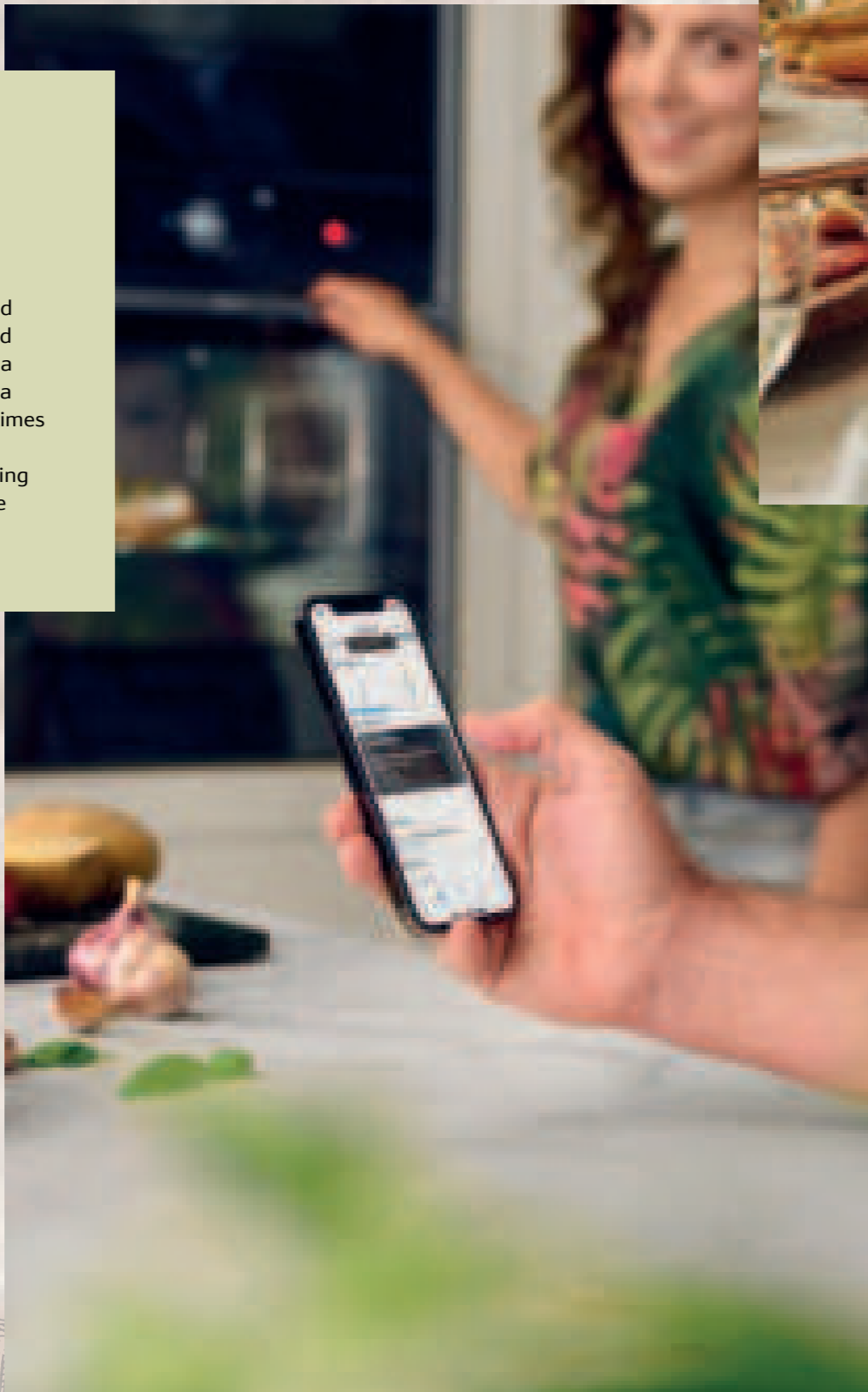

Looking for Inspiration?

Want to find a new way to cook something or have a lot of seasonal ingredients? Spend some time with our recipe partners on NEFF Home Connect and be inspired by others!



Got your hands full creating your next dish?

Achieving perfect results has never been easier with Oven Assistant – simply use the NEFF Home Connect app or ask Alexa to find the perfect setting for your dish.



Sharing Favourites

We all have our favourite recipes, the ones that connect us, make us feel nostalgic and the ones that keep us at the table until the last morsel has been enjoyed. Let your oven in on the secret – share oven settings for your favourite recipe for quick, convenient access and it'll be ready to go whenever you feel inspired!



NEFF is here for you EVERY STEP OF THE WAY

We are fully committed to providing excellent customer service and support. Our dedicated team of engineers is available to assist you with product advice, spare parts, accessories, and repairs. We aim to resolve your issues on the same day of the service visit. Our exceptional service has been recognized by the industry with the TEQ Award for 10 consecutive years. Additionally, we have received positive reviews on TrustPilot, earning us an excellent rating of 4.7.*



4.7
Score as of February 2026



NEFF Warranties

Our support includes a comprehensive range of warranties, with 2 years of warranty on all appliances as the standard, and some models offering a 5-year warranty*. We also provide product and category warranties for Refrigeration, Dish, and Laundry, ensuring peace of mind for our customers.



All NEFF home appliances come complete with a 2 years warranty as standard to protect against any manufacturing or material faults during this period.



For a limited time only, selected NEFF home appliances come with a free 5 years warranty. Offer applies to selected NEFF models purchased between 01.04.26 - 31.03.27 and registered within 3 months of purchase.



This 10 years warranty covers the Compressor Drive motor only on selected NEFF refrigeration appliances.



This 10 years warranty protects against rust in the inner cavity of NEFF dishwashers. Valid on all NEFF dishwashers purchased from 01.01.2012

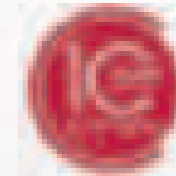

This 10 years warranty protects the motor on your washing machine, ensuring it runs as efficiently as possible.



This lifetime warranty protects against water damage caused by a defective Aqua Stop system. Valid on all NEFF washing machines and NEFF dishwashers with an Aqua Stop system.

*To check if your product qualifies, please see our website or call us. Contact details available on pages 262-263.

Support And Product Advice

Prefer to go online? You can visit our support content at: neff-home.com/uk/service/support to quickly find the help you need. We cover questions about usage and maintenance of your appliance, as well as tips on getting started and installing your new appliances. You'll also be able to access your user manual at any time.



Join our online community

Choose NEFF and join a community of passionate home cooks and professionals who value quality and creativity in the kitchen.



* Trust Pilot 4.7 as at February 2026

The NEFF OVEN RANGE



NEFF's overall range gives customers two levels of choice – Core Range & Flex Design.



Graphite Grey

Stainless Steel



Flex Design Range

Introduced in 2023, the Flex Design Range extends the N90/N70 feature set to ovens, hobs and hoods while adding a higher level of design customisation: appliances can be finished in four coordinated colours (Brushed Bronze, Deep Black, Anthracite Grey and Metallic Silver) so they can better match the kitchen.



FLEX DESIGN

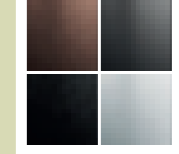

Throughout the brochure the majority of the range is Core but where there is a Flex Design option available it is clearly indicated as there is an additional ordering process to follow to complete the appliance.



Brushed Bronze

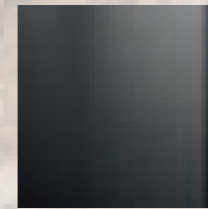

Anthracite Grey



Metallic Silver

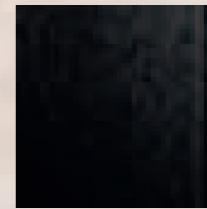

Deep Black



NEFF Oven Range 2026

An oven for EVERY COOK and kitchen

Appliances tailored to you - customise your range on cooking function, design & user interface



FLEX DESIGN

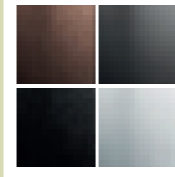

For complete personalisation

Personalise your oven appliances with easily interchangeable Flex Design Trim, available in four distinctive colours, to coordinate with the design of your kitchen.

Comes with 5 year warranty.



VALUE CLASS	DISPLAY TYPE	DESIGN	COLOURS	60CM SINGLE SLIDE & HIDE® OVEN RANGE			
				WITH INTENSIVE STEAM	WITH VARIO STEAM®	PYROLYTIC	
N90	FULL TOUCH 3 - 6.8" FULL TOUCH TFT DISPLAY Flex Design models in this range can have the additional Twist Pad Flex® for dial control option.	Flex Design	4 Trim Colours Available	B69FY5CX0 • Fixed water connection until September 2026.* • Multipoint Temperature Probe	B69VY7MY0 • Water tank • Multipoint Temperature Probe	B69CY7MY0 • Multipoint Temperature Probe	
		Core Range	Graphite Grey				
N90	FULL TOUCH 2 - 4.1" FULL TOUCH TFT DISPLAY	Flex Design	4 Trim Colours Available	B69FSCY0A** • Water tank • Multipoint Temperature Probe	B69VS7MY0A • Water tank • Multipoint Temperature Probe	B69CS7MY0B • Multipoint Temperature Probe	
		Core Range	Graphite Grey	B64FS31G0B • Water tank	B64VS71G0B • Water tank	B64CS71G0B	
N70	FULL TOUCH 1 - N70 3.7" FULL TOUCH TFT DISPLAY	Flex Design	4 Trim Colours Available	Rotating Handle with Soft Open			
		Core Range	Graphite Grey		B59CR7KY0B		
N50	DIAL CONTROL & LCD SCREEN	Core Range	Graphite Grey		B54CR71G0B	B54CR31G0B	
		Core Range	Stainless Steel		B54CR71N0B	B54CR31N0B	
N50	DIAL CONTROL & LCD SCREEN	Core Range	Graphite Grey	Slide & Hide with Fixed Handle			
		Core Range	Stainless Steel		B6ACH7AG7B	B3ACE4AG3B	
N50	DIAL CONTROL & LCD SCREEN	Core Range	Stainless Steel		B6ACH7AN7B	B3ACE4AN3B	B4ACF1AN3B • Rotating handle
		Core Range	Stainless Steel				

60CM OVEN WITH DROP DOWN DOOR		45CM COMPACT				38CM COMPACT MICROWAVES		
PYROLYTIC		WITH STEAM	WITH MICROWAVE		MICROWAVE	COFFEE MACHINE	Pyrolytic	WITH MICROWAVE
		C29FY5CX0 • Fixed water connection until September 2026.*** • Multipoint Temperature Probe	C29MY7MY0 • Multipoint Temperature Probe			CL9TX11X0 • Fixed water connection until September 2026.****		
						CL4TT11G0 • Water Tank. This is the only large screen in the Core Range		
		C29FS3AY0	C29MS7KY0					
		C24FS31G0B	C24MS31G0B	C24MS71G0B				
			C29MR21Y0B				NL9WR21Y1B	NR9WR21Y1B
			C24MR21G0B		C24GR3XG1B		NL4WR21G1B	NR4WR21G1B
			C24MR21N0B					
B2ACH7AG7B	B1ACE4AG3B		C1AMG84G1B					HLAWD23G0B
			C1AMG84N1B				HLAWD53N0B	HLAWD23N0B

* B69FY5CX0 will change to B69FY3CY2A in September 2026. All Fixed water connection models will change to a water tank for steam and coffee centre.

** B69FSCY0A will change to B69FS3CY2A in September 2026 as the cleaning process will change from Eco Clean to Intensive Steam cleaning

*** C29FY5CX0 will change to C29FY3CY2 in September 2026.

**** CL9TX11X0 will change to CL9TX11Y0 in September when it changes from fixed to water tank.

Key Functions Guide

Cooking Functions



CIRCO THERM®

Circo Therm® evenly distributes the hot air throughout the oven, allowing for consistent cooking results on multiple trays simultaneously.



CIRCO ROASTING

Circo Roasting is the ideal function for cooking meat and poultry. The circulating hot air helps to sear the exterior of the meat quickly, locking in juices and flavour while creating a crispy, golden-brown crust. Meanwhile, the interior remains moist and tender.



TOP/BOTTOM HEAT

Providing conventional cooking heat sources at the top and bottom of the oven. Heat travels to the centre of the oven by natural conduction. Ideal for baking pastries and scones.



CENTRE SURFACE GRILL

When the Centre Surface Grill function is activated, only the centre grilling elements will heat up. Ideal for when cooking smaller quantities.



LOW TEMPERATURE COOKING

A special setting for hob-sealed prime cuts of meat and poultry. Meat/poultry is placed in a pre-heated dish and transferred into the oven. The low temperature setting uses a fixed temperature to gently tenderise without overcooking, resulting in meat/poultry that is juicy and melts in the mouth.



BREAD BAKING

Bread baking temperature varies between 180°C and 220°C. Ideally suited to baking crusty bread with an open texture. Up to three levels of bread can be baked at the same time.



KEEP WARM

An ideal setting for keeping food warm without drying it out before serving. Typically set between 66°C to 100°C.

Special Features



NEFF Home Connect

Control your oven directly from a smartphone or voice assistant. You can also download updates and additional functions.



BAKING AND ROASTING ASSISTANT

Baking & Roasting Assistant helps you to cook meals with ease, by simply selecting pre-selected food items from the Bake & Roast Assist menu. Select your meal on the display and you will find a suggested temperature & cooking time. For Baking, Roasting & Grilling the entire process gives perfect cooking results.



CIRCO THERM® GENTLE

Circo Therm® Gentle is designed for delicate cooking tasks that require gentle heat and precise temperature control. Operating at a lower temperature, it is perfect for baking delicate pastries, or slow cooking.



CIRCO THERM® INTENSIVE

Uses a combination of Circo Therm® and bottom heat, ideal for foods that need a crispy underside like pizzas or specialty breads. It can also be used for one stage pastry such as lemon meringue pie, eliminating the need for blind baking.



BOTTOM HEAT

Providing heat from the bottom of the oven, this method is ideal for pizza bases and pastry cases to create a crispy underside or for bain marie and casseroles.



FULL SURFACE GRILL

The grill element is situated in the oven roof. It is thermostatically controlled and will cycle on and off to maintain the required temperature.

AIR FRY

The convenience of an Air Fryer inside the oven. This feature uses the grill and fan to create the same results. Using our Air Fryer and Grill Tray (Z1655CA0) further helps the air to circulate achieving optimum results.



DOUGH PROVING

The Dough Proving function provides a controlled environment with a low and consistent temperature ideal for proofing dough. This feature offers home bakers a convenient and reliable way to proof dough, ensuring consistent results and saving time in the bread making process.



PLATE WARMING

Hot air is circulated at up to 65°C to safely warm plates and service dishes in preparation for dinner.



MEAT PROBE

The Multi Point Meat Probe measures the joint's heat at three points ensuring the right core temperature is reached, so you can take the roast out when it's ready.

Cooking Functions With Steam



VARIO STEAM®

Vario Steam® enhances the cooking process by introducing controlled bursts of steam into the oven. Whether you're baking bread, roasting meats, or reheating leftovers, dishes come out with more intense flavour and an appetising appearance.



REHEAT

Reheat allows you to gently warm dishes again – and thanks to the moisture in the oven, they will look and taste freshly prepared.



INTENSIVE STEAM (FULL STEAM)

Make your favourite dishes healthier with our Intensive steam function. Gently cook your dishes at up to 120°C, to preserve their natural flavour and lock in nutrients. It's easy to operate and also simple to refill the one litre water container – press a button to open the front panel, remove the container, fill it and you're ready to steam ahead.

Oven Cleaning Functions



PYROLYTIC SELF-CLEANING

Pyrolytic cleaning is a self-cleaning system for ovens. The process superheats the oven to approximately 485°C, which burns off any deposits from baking, roasting and grilling. This creates a perfectly clean oven and a residue of fine dust that's easily removed with a damp cloth.



OVEN CLEANING

A special electronic setting designed to keep EcoClean® surfaces inside the oven as clean as possible. Used on a regular basis, it can keep the oven's interior lining remarkably clean with minimal maintenance required.



BASE CLEAN

Base Clean helps clean the bottom of the oven by softening dirt with warm water. After the programme has finished you just have to wipe the base with a damp cloth.

DRYING FUNCTION

Dries the cooking compartment after a steam function.



EASY CLEAN®

For a lightly soiled oven, put approximately 400ml of water and a drop of washing-up liquid in the base pan and then select the EasyClean® programme. It softens baked-on residue so you can just wipe it down, for fast and uncomplicated oven cleaning.



DESCALING

All NEFF steam appliances contain a descaling programme which can be set according to the hardness of the water.



ECO CLEAN

Eco Clean is a microfine ceramic bead coating on the oven's interior back, top or sides, depending on the model. It has a very large surface area, making it extremely absorbent. It absorbs fat droplets and keeps the inside of the oven clean.

AUTOMATIC SAFETY SWITCH OFF

For electronic ovens only, this feature will automatically cut in if no changes to the settings on the appliance have been made in a long time, giving you complete peace of mind.





Temperature range	Automatic switch off after
Under 140°C	73 hours
141 – 200°C	6 hours
201 – 250°C	3 hours
251°C	2 hours

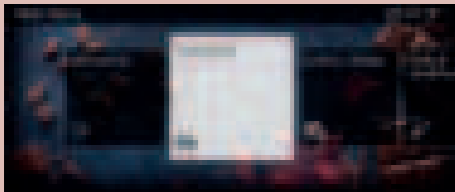
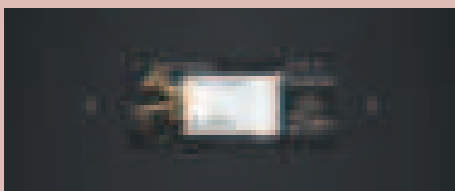
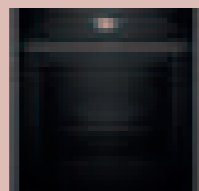

N90 and N70 Oven Range

All single ovens have:
• Circo Therm®

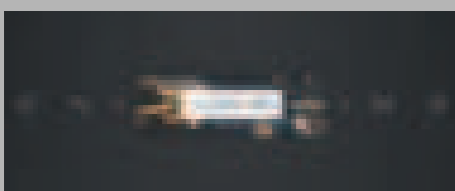



DISPLAY TYPE	SLIDE & HIDE® SINGLE OVENS - WITH ROTATING HANDLE AND SOFT/OPEN CLOSE			
	WITH INTENSIVE STEAM	WITH VARIO STEAM® PYROLYTIC	PYROLYTIC	
 <p>N90 - FULL TOUCH 3 – 6.8" FULL TOUCH TFT DISPLAY Only the Coffee Machine is available in the large FT3 screen in the Core Range</p>				
 <p>N90 - FULL TOUCH 2 – 4.1" FULL TOUCH TFT DISPLAY Airfry Function and Airfry Grid Tray available as a standard on all appliances.</p>	 <p>B64FS31G0B • 22 Functions • Intensive Steam - with water tank</p>	 <p>B64VS71G0B • 20 Functions • Vario Steam® - with water tank • Pyrolytic</p>	 <p>B64CS71G0B • 14 Functions • Pyrolytic</p>	
DISPLAY TYPE	SLIDE & HIDE® SINGLE OVENS - WITH SOFT OPEN			
 <p>N70 FULL TOUCH 1 – 3.7" FULL TOUCH TFT DISPLAY Airfry Function and Airfry Grid Tray available as a standard on all appliances.</p>			 <p>GRAPHITE GREY B54CR71G0B STAINLESS STEEL B54CR71N0B • 14 Functions • Pyrolytic</p>	 <p>GRAPHITE GREY B54CR31G0B STAINLESS STEEL B54CR31N0B • 14 Functions</p>





All compact ovens have:
• Soft Open / Close door

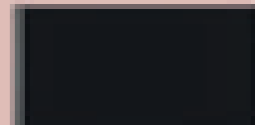











COMPACT OVENS			COFFEE MACHINE	MICROWAVES	
WITH STEAM	WITH MICROWAVE			WITHOUT GRILL	DROP DOWN DOOR WITH GRILL
			 <p>CL4TT11G0 • 11 Functions • Left Hinged Door</p>		
 <p>C24FS31G0B • 22 Functions • Intensive Steam - with water tank *Does not include Airfry Grid Tray</p>	 <p>C24MS31G0B • 20 Functions</p>	 <p>C24MS71G0B • 20 Functions • Pyrolytic</p>			
	 <p>GRAPHITE GREY C24MR21G0B STAINLESS STEEL C24MR21N0B • 20 Functions</p>			 <p>LEFT HINGE NL4WR21G1B RIGHT HINGE NR4WR21G1B • Up to 900w • 5 power levels</p>	 <p>C24GR3XG1B • Up to 1000w • 9 power levels • MW + grill</p>

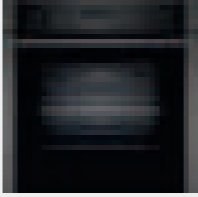

DISPLAY TYPE	14CM DRAWERS WARMING DRAWER	29CM DRAWERS WARMING DRAWER
<p>All drawers have: • Push / Pull opening • 6 temperature settings (excludes Accessory Drawer)</p> 	 <p>GRAPHITE GREY N24HA11G1B STAINLESS STEEL N24HA11N1B</p>	 <p>GRAPHITE GREY N34HA11G1B STAINLESS STEEL N34HA11N1B</p>

N50 Oven Range

DISPLAY TYPE	SLIDE & HIDE® SINGLE OVENS - WITH FIXED HANDLE*		
	PYROLYTIC		
GRAPHITE GREY WITH LCD DISPLAY	 <p>B6ACH7AG7B • 8 Functions • Pyrolytic</p>	 <p>B3ACE4AG3B • 7 Functions</p>	
STAINLESS STEEL WITH LCD DISPLAY	 <p>B6ACH7AN7B • 8 Functions • Pyrolytic</p>	 <p>B3ACE4AN3B • 7 Functions</p>	 <p>B4ACF1AN3B • 6 Functions • *Rotating Handle</p>

DISPLAY TYPE	DOUBLE OVEN RANGE		BUILT UNDER DOUBLE OVEN RANGE
	STAINLESS STEEL WITH LCD DISPLAY	 <p>U2ACH7AN7B • 8/4 Functions • Pyrolytic</p>	 <p>U1ACE2AN3B • 5/4 Functions</p>
GRAPHITE GREY WITH LCD DISPLAY	 <p>U2ACH7AG7B • 8/4 Functions • Pyrolytic</p>	 <p>U1ACE2AG3B • 5/4 Functions</p>	

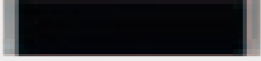
OVENS WITH DROP DOWN DOOR	COMPACT OVENS	MICROWAVES		
 <p>B2ACH7AG7B • 8 Functions • Pyrolytic</p>	 <p>B1ACE4AG3B • 6 Functions</p>	 <p>C1AMG84G1B • 3 Functions • Microwave</p>	 <p>HLAWD23G0B • 5 Functions</p>	
		 <p>C1AMG84N1B • 3 Functions • Microwave</p>	 <p>HLAWD53N0B • 5 Functions</p>	 <p>HLAWD23N0B • 5 Functions</p>

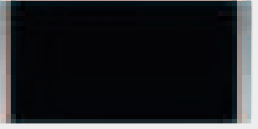
WARMING DRAWERS	14CM DRAWERS		29CM DRAWERS
	STAINLESS STEEL	GRAPHITE GREY	STAINLESS STEEL
<p>All drawers have:</p> <ul style="list-style-type: none"> • Push / Pull opening • 6 temperature settings (excludes Accessory Drawer) 	 <p>N1AHA01N0B</p>	 <p>N1AHA01G0B</p>	 <p>N1AHA02N0B</p>

N90 Full Touch 2 Single & Compact Ovens

- Electronic, 4.1" Full Touch TFT Display on all models
- All ovens feature Circo Therm®



	60CM SLIDE & HIDE® SINGLE OVEN		
	INTENSIVE STEAM B64FS31G0B N90	VARIO STEAM® B64VS71G0B N90	PYROLYTIC B64CS71G0B N90
	<ul style="list-style-type: none"> • 22 functions, inc. Full Steam • Rotating handle • Soft open/close door • Graphite Grey 	<ul style="list-style-type: none"> • 20 functions, inc. Vario Steam® • Rotating handle • Soft open/close door • Graphite Grey 	<ul style="list-style-type: none"> • 14 functions • Rotating handle • Soft open/close door • Graphite Grey
CONTROLS			
Electronic control	•	•	•
Temperature proposal with display	•	•	•
Heating up indicator / Residual heat indicator	•/•	•/•	•/•
Control panel lock / Safety switch off	•/•	•/•	•/•
Automatic programmes	•	•	•
SPECIAL FEATURES			
Door type	Slide & Hide® With Rotating Handle, Soft Open & Soft Close	Slide & Hide® With Rotating Handle, Soft Open & Soft Close	Slide & Hide® With Rotating Handle, Soft Open & Soft Close
Soft open door	•	•	•
Oven Assistant with Voice Control	•	•	•
NEFF Home Connect	•	•	•
Telescopic Rail	Available as an accessory	Available as an accessory	Available as an accessory
Multi Point Temperature Probe			
Single Point Meat Probe			
Rapid heat up	•	•	•
Baking and roasting assistant	•	•	•
FEATURES			
Electronic clock / timer	White TFT Display	White TFT Display	White TFT Display
Full glass inner door	•	•	•
Glazed door (Quadruple / Triple/Double)	Triple (CoolTouch door)	Quadruple (CoolTouch door)	Quadruple (CoolTouch door)
Internal lighting	LED Light	LED Light	LED Light
Water tank empty indicator	•	•	•
COOKING FUNCTIONS	23	20	14
FullSteam 100% / Intensive Steam	•	•	•
Vario Steam®	•	•	•
Steam Boost	•	•	•
Keep Warm with Added Steam / Reheat with Added Steam	•/•	•	•
Airfry Function	•	•	•
Circo Therm®	•	•	•
Circo Therm® Gentle / Top / bottom heat Gentle	•/•/•	•/•/•	•/•/•
Bottom heat	•	•	•
Conventional heat / Conventional heat gentle	•/•	•/•	•/•
Low temperature cooking / Pre-heating	•/•	•/•	•/•
Circo Roasting / Hot air grilling	•/•	•/•	•/•
Full surface grill / Centre Surface Grill	•/•	•/•	•/•
Bread Baking Function / Pizza setting / Plate warming	•/•/•	•/•/•	•/•/•
Defrost / Dough Proving / Keep warm	•/•/•	•/•/•	•/•/•
Microwave Power Settings	W		
Microwave Cooking Programmes			
OVEN CLEANING			
Pyrolytic cleaning		•	•
Easy Clean® / Base Clean	•/•	•/•	•/•
Eco Clean Surface	•	•	•
Cleaning setting	•	•	•
Descaling programme	•	•	•
STANDARD ACCESSORIES			
Universal pan	1	1	1
Steam Container	3		
Combination Grid	2	2	2
Airfry Grid Tray	1	1	1
ENERGY EFFICIENCY:			
Energy efficiency class	A+	A+	A+
Energy consumption per cycle Circo Therm® kWh	0.69	0.69	0.69
Energy consumption per cycle conventional kWh	0.87	0.87	0.87
Oven capacity L	71	71	71
Time to cook standard load mins	44	44	44
Largest baking sheet area cm²	1290	1290	1290
TECHNICAL INFORMATION			
Total connected load kW	3.6	3.6	3.6

	45CM COMPACT OVENS		
	INTENSIVE STEAM C24FS31G0B N90	PYROLYTIC/WITH MICROWAVE C24MS71G0B N90	MICROWAVE C24MS31G0B N90
	<ul style="list-style-type: none"> • 22 functions, inc. Full Steam • Soft open/close door • Graphite Grey 	<ul style="list-style-type: none"> • 20 functions, inc. Pyrolytic • Soft open/close door • Graphite Grey 	<ul style="list-style-type: none"> • 20 functions • Soft open/close door • Graphite Grey
CONTROLS			
Electronic control	•	•	•
Temperature proposal with display	•	•	•
Heating up indicator / Residual heat indicator	•/•	•/•	•/•
Control panel lock / Safety switch off	•/•	•/•	•/•
Automatic programmes	•	•	•
SPECIAL FEATURES			
Door type	Drop Down, Soft Open & Soft Close	Drop Down, Soft Open & Soft Close	Drop Down, Soft Open & Soft Close
Soft open door	•	•	•
Oven Assistant with Voice Control	•	•	•
NEFF Home Connect	•	•	•
Telescopic Rail	Available as an accessory	Factory Fitted	Factory Fitted
Multi Point Temperature Probe			
Single Point Meat Probe			
Rapid heat up	•	•	•
Baking and roasting assistant	•	•	•
FEATURES			
Electronic clock / timer	White TFT Display	White TFT Display	White TFT Display
Full glass inner door	•	•	•
Glazed door (Quadruple / Triple/Double)	Triple (CoolTouch door)	Quadruple (CoolTouch door)	Triple (CoolTouch door)
Internal lighting	LED Light	LED Light	LED Light
Water tank empty indicator	•	•	•
COOKING FUNCTIONS	23	20	14
FullSteam 100% / Intensive Steam	•	•	•
Vario Steam®	•	•	•
Steam Boost	•	•	•
Keep Warm with Added Steam / Reheat with Added Steam	•/•	•	•
Airfry Function	•	•	•
Circo Therm®	•	•	•
Circo Therm® Gentle / Top / bottom heat Gentle	•/•/•	•/•/•	•/•/•
Bottom heat	•	•	•
Conventional heat / Conventional heat gentle	•/•	•/•	•/•
Low temperature cooking / Pre-heating	•/•	•/•	•/•
Circo Roasting / Hot air grilling	•/•	•/•	•/•
Full surface grill / Centre Surface Grill	•/•	•/•	•/•
Bread Baking Function / Pizza setting / Plate warming	•/•/•	•/•/•	•/•/•
Defrost / Dough Proving / Keep warm	•/•/•	•/•/•	•/•/•
Microwave Power Settings		90, 180, 360, 600, boost	90, 180, 360, 600, boost
Microwave Cooking Programmes		•	•
OVEN CLEANING			
Pyrolytic cleaning		•	•
Easy Clean® / Base Clean	•/•	•/•	•/•
Eco Clean Surface	•	•	•
Cleaning setting	•	•	•
Descaling programme	•	•	•
STANDARD ACCESSORIES			
Universal pan	1		
Steam Container	3		
Combination Grid	2		
Airfry Grid Tray	1	1	1
ENERGY EFFICIENCY:			
Energy efficiency class	A+	A+	A+
Energy consumption per cycle Circo Therm® kWh	0.61	0.61	0.61
Energy consumption per cycle conventional kWh	0.73	0.73	0.73
Oven capacity L	47	45	45
Time to cook standard load mins	40.5		
Largest baking sheet area cm²	1290	1290	1290
TECHNICAL INFORMATION			
Total connected load kW	3.3	3.6	3.6

1 Measured according the EN50304, 65/2014. 2 For further information on inverter technology, please go to www.neffhome.com/uk/. 3For Inverter models, the maximum setting offers a time limited boost option for heating liquids. To ensure optimal results and to protect the appliance, the microwave power output is reduced in stages over the first few minutes down to the next power level (600W). After a cooling period, the microwave boost option will be available once more.

N90 Full Touch 3 Single & Coffee Machine

- Electronic, 6.8" Premium Full Touch TFT Display on all models. The only appliance in the range to have this size screen.



45CM COFFEE CENTRE CL4TT11G0 | N90

- Multiple international coffee variations
- Strength and aroma management
- Left hinged door
- Graphite Grey
- Not possible to seamlessly combine this appliance

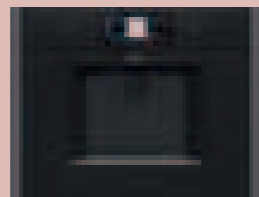

OPERATION	
Premium Full Touch TFT Display Type	Full Touch 3
Screen Size	6.8"
CONTROLS	
Electronic control	•
Water level indicator	•
Descaling indicator	•
Automatic programmes	•
Child Safety	•
Child Lock	•
NEFF Home Connect	•
FEATURES	
Left-hand Door Hinge	•
Automatic milk amount detection	•
Height adjustable beverage outlet (max 15cm)	•
One Touch Double Cup	•
Illuminated coffee outlet, stage and interior	•
Water Pump (19 bar pressure)	•
6 adjustable grinding degree settings (multi-level)	•
30 min Auto-standby	•
FLAVOUR FEATURES	
Up to 29 Coffee Specialties	•
Coffee Pot Function	•
Aroma Select	•
Warm milk	•
Milk froth	•
Hot water function	•
Adjustable milk ratio	•
Intelligent strength adjustment	•
AromaDouble Shot	•
CLEANING	
Auto Milk Clean	•
Calc'nClean	•
Removable Brewing Unit	•
Dishwasher Proof (beverage outlet, drip tray/pans)	•
Automatic reminder	•
ACCESSORIES	
Test strip	•
Cleaning Tablets	•
Descaling Tablets	•
BRITA Intenza Water Filter	•
Care set	•
ENERGY EFFICIENCY	
Nominal Voltage	V 220-240
Total connected load	kW 1.5
Mains Frequency	Hz 50 / 60
TECHNICAL INFORMATION	
Appliance Dimensions HxWxD	mm 455x594x385
Mounted Dimensions HxWxD	mm 449x558x376
Removable water tank	L 2.4
Integrated milk container	L 0.5
Bean container with aroma protection lid	g 500
Cable length	cm 170

N70 Full Touch 1 Single Ovens

- Electronic, 3.7" Full Touch TFT Display on all models
- All ovens feature Circo Therm®



OPERATION	
Premium Full Touch TFT Display Type	Full Touch 1
Screen Size	3.7"
CONTROLS	
Electronic control	•
Temperature proposal with display	•
Heating up indicator / Residual heat indicator	•/•
Control panel lock / Safety switch off	•/•
Automatic programmes	•
SPECIAL FEATURES	
Door type	Slide & Hide® With Rotating Handle, Soft Open
Soft open door	•
Oven Assistant with Voice Control	•
NEFF Home Connect	•
Telescopic Rail	Available as an accessory
Rapid heat up	•
Baking and roasting assistant	•
FEATURES	
Electronic clock / timer	•
Full glass inner door	•
Glazed door (Quadruple / Triple / Double)	Quadruple (CoolTouch door)
Internal lighting	LED Light
Water tank empty indicator	•
COOKING FUNCTIONS	
Circo Therm®	•
Circo Therm® Gentle / Top / bottom heat Gentle	•/•/•
Airfry Function	•
Bottom heat	•
Conventional heat / Conventional heat gentle	•/•
Low temperature cooking / Pre-heating	•/•
Circo Roasting / Hot air grilling	/•
Full surface grill / Centre Surface Grill	•/•
Bread Baking Function / Pizza setting / Plate warming	/•/•
Defrost / Dough Proving / Keep warm	/•/•
OVEN CLEANING	
Pyrolytic cleaning	•
Easy Clean® / Base Clean	•/•
Eco Clean Surface	•
Cleaning setting	•
STANDARD ACCESSORIES	
Universal pan	1
Combination Grid	2
Airfry Grid Tray	1
ENERGY EFFICIENCY ¹	
Energy efficiency class	A+
Energy consumption per cycle Circo Therm®	kWh 0.69
Energy consumption per cycle conventional	kWh 0.87
Oven capacity	L 71
Time to cook standard load	mins 44
Largest baking sheet area	cm ² 1290
TECHNICAL INFORMATION	
Total connected load	kW 3.6



60CM SLIDE & HIDE® SINGLE OVEN



PYROLYTIC B54CR71G0B N70	PYROLYTIC / STAINLESS STEEL B54CR71N0B N70	B54CR31G0B N70	STAINLESS STEEL B54CR31N0B N70
• 14 functions • Rotating handle • Soft open door • Graphite Grey	• 14 functions • Rotating handle • Soft open door • Stainless Steel	• 14 functions • Rotating handle • Soft open door • Graphite Grey	• 14 functions • Rotating handle • Soft open door • Stainless Steel
Full Touch 1 3.7"	Full Touch 1 3.7"	Full Touch 1 3.7"	Full Touch 1 3.7"
•	•	•	•
•	•	•	•
•/•	•/•	•/•	•/•
•/•	•/•	•/•	•/•
•	•	•	•
Slide & Hide® With Rotating Handle, Soft Open	Slide & Hide® With Rotating Handle, Soft Open	Slide & Hide® With Rotating Handle, Soft Open	Slide & Hide® With Rotating Handle, Soft Open
•	•	•	•
•	•	•	•
•	•	•	•
Available as an accessory	Available as an accessory	Available as an accessory	Available as an accessory
•	•	•	•
•	•	•	•
White TFT Display	White TFT Display	White TFT Display	White TFT Display
•	•	•	•
Quadruple (CoolTouch door)	Quadruple (CoolTouch door)	Triple (CoolTouch door)	Quadruple (CoolTouch door)
LED Light	LED Light	LED Light	LED Light
14	14	14	14
•	•	•	•
•/•/•	•/•/•	•/•/•	•/•/•
•	•	•	•
•	•	•	•
•/•	•/•	•/•	•/•
•/•	•/•	•/•	•/•
/•	/•	/•	/•
•/•	•/•	•/•	•/•
/•/•	/•/•	/•/•	/•/•
/•/•	/•/•	/•/•	/•/•
•	•	•	•
•/•	•/•	•/•	•/•
•	•	•	•
1	1	1	1
2	2	2	2
1	1	1	1
A+	A+	A+	A+
0.69	0.69	0.69	0.69
0.87	0.87	0.87	0.87
71	71	71	71
44	44	44	44
1290	1290	1290	1290
3.6	3.6	3.6	3.6

¹ Measured according to the EN50304, 65/2014. ² For further information on inverter technology, please go to www.neffhome.com/uk. ³ For Inverter models, the maximum setting offers a time limited boost option for heating liquids. To ensure optimal results and to protect the appliance, the microwave power output is reduced in stages over the first few minutes down to the next power level (600W). After a cooling period, the microwave boost option will be available once more.

N70 Full Touch 1 Compact Ovens with Microwave & Compact Microwaves

- Electronic, 3.7" Full Touch TFT Display on all models

45CM COMPACT OVENS		45CM COMPACT MICROWAVE
WITH MICROWAVE C24MR21G0B N70	WITH MICROWAVE C24MR21N0B N70	WITH GRILL C24GR3XG1B N70
<ul style="list-style-type: none"> • 20 functions • Soft open/close door • Graphite Grey 	<ul style="list-style-type: none"> • 20 functions • Soft open/close door • Stainless Steel 	<ul style="list-style-type: none"> • MW plus Grill with combination option, up to 1000W MW output • Soft close door • Graphite Grey • Not possible to seamlessly combine this appliance 

38CM MICROWAVE	
WITHOUT GRILL/LEFT OPENING NL4WR21G1B N70	WITHOUT GRILL/RIGHT OPENING NR4WR21G1B N70
<ul style="list-style-type: none"> • MW only, up to 900W MW output, 21L • Left hinged door • Graphite Grey 	<ul style="list-style-type: none"> • MW only, up to 900W MW output, 21L • Right hinged door • Graphite Grey 

OPERATION			
Premium Full Touch TFT Display Type	Full Touch 1	Full Touch 1	Full Touch 1
Screen Size	3.7"	3.7"	3.7"
CONTROLS			
Electronic control	•	•	•
Temperature proposal with display	•	•	•
Heating up indicator / Residual heat indicator	•/•	•/•	•/•
Control panel lock / Safety switch off	•/•	•/•	•/•
Automatic programmes	•	•	•
SPECIAL FEATURES			
Door type	Drop Down, soft open, soft close	Drop Down, soft open, soft close	Drop Down, soft close
Soft open door	•	•	
Oven Assistant with Voice Control	•	•	
NEFF Home Connect	•	•	
Telescopic Rail	Factory Fitted	Factory Fitted	
Multi Point Temperature Probe			
Single Point Meat Probe			
Rapid heat up	•	•	•
Baking and roasting assistant	•	•	
FEATURES			
Electronic clock / timer	•	•	•
Full glass inner door	•	•	•
Glazed door (Quadruple / Triple/Double)	Triple (CoolTouch door)	Triple (CoolTouch door)	Triple (CoolTouch door)
Internal lighting	LED Light	LED Light	LED Light
Water tank empty indicator			
COOKING FUNCTIONS			
FullSteam 100% / Intensive Steam	1 heating mode	1 heating mode	2 heating mode
Circo Therm® with Added Steam			
Dough Proving with Added Steam			
Keep Warm with Added Steam / Reheat with Added Steam			
Airfry	•	•	•
Sous-vide cooking			
Circo Therm®			
Circo Therm® Gentle / Top / bottom heat Gentle			
Bottom heat			
Conventional heat / Conventional heat gentle			
Low temperature cooking / Pre-heating			
Circo Roasting / Hot air grilling			
Full surface grill / Centre Surface Grill			•/
Bread Baking Function / Pizza setting / Dough proving			
Defrost / Plate warming / Keep warm			
Microwave Power Settings	W 90, 180, 360, 600, boost	90, 180, 360, 600, boost	90, 180, 360, 600, 1000
Microwave Cooking Programmes	•	•	3 Defrost / 4 Cooking
OVEN CLEANING			
Pyrolytic cleaning			
Easy Clean® / Base Clean	•/•	•/•	•/•
Eco Clean Surface			
Cleaning setting	•	•	•
Descaling programme			
STANDARD ACCESSORIES			
Universal pan	1	1	1
Combination Grid	1	1	
Airfry Grid Tray	1	1	1
ENERGY EFFICIENCY ¹			
Energy efficiency class			
Energy consumption per cycle Circo Therm®	kWh		
Energy consumption per cycle conventional	kWh		
Oven capacity	L 45	45	36
Time to cook standard load	mins		
Largest baking sheet area	cm ² 1290	1290	
TECHNICAL INFORMATION			
Total connected load	kW 3.6	3.6	3.1

OPERATION		
Premium Full Touch TFT Display Type	Full Touch 1	Full Touch 1
Screen Size	3.7"	3.7"
CONTROLS		
Electronic control	•	•
Temperature proposal with display	•	•
Heating up indicator / Residual heat indicator	•/•	•/•
Control panel lock / Safety switch off	•/•	•/•
Automatic programmes	•	•
SPECIAL FEATURES		
Door type	Left hinged door	Right hinged door
Soft open door		
Oven Assistant with Voice Control		
NEFF Home Connect		
Telescopic Rail		
Multi Point Temperature Probe		
Single Point Meat Probe		
Rapid heat up	•	•
Baking and roasting assistant		
FEATURES		
Electronic clock / timer	•	•
Full glass inner door	•	•
Glazed door (Quadruple / Triple/Double)	Double	Double
Internal lighting	LED Light	LED Light
Water tank empty indicator		
COOKING FUNCTIONS		
FullSteam 100% / Intensive Steam	1 heating mode	1 heating mode
Circo Therm® with Added Steam		
Dough Proving with Added Steam		
Keep Warm with Added Steam / Reheat with Added Steam		
Airfry		
Sous-vide cooking		
Circo Therm®		
Circo Therm® Gentle / Top / bottom heat Gentle		
Bottom heat		
Conventional heat / Conventional heat gentle		
Low temperature cooking / Pre-heating		
Circo Roasting / Hot air grilling		
Full surface grill / Centre Surface Grill		
Bread Baking Function / Pizza setting / Dough proving		
Defrost / Plate warming / Keep warm		
Microwave Power Settings	90, 180, 360, 600, 900	90, 180, 360, 600, 900
Microwave Cooking Programmes	3 Defrost / 4 Cooking	3 Defrost / 4 Cooking
OVEN CLEANING		
Pyrolytic cleaning		
Easy Clean® / Base Clean	•/•	•/•
Eco Clean Surface		
Cleaning setting	•	•
Descaling programme		
STANDARD ACCESSORIES		
Universal pan		
Combination Grid		
Airfry Grid Tray		
ENERGY EFFICIENCY ¹		
Energy efficiency class		
Energy consumption per cycle Circo Therm®	kWh	
Energy consumption per cycle conventional	kWh	
Oven capacity	L 21	21
Time to cook standard load	mins	
Largest baking sheet area	cm ²	
TECHNICAL INFORMATION		
Total connected load	kW 1.22	1.22





1 Measured according to the EN50304, 65/2014. 2 For further information on inverter technology, please go to www.neffhome.com/uk. 3 For Inverter models, the maximum setting offers a time limited boost option for heating liquids. To ensure optimal results and to protect the appliance, the microwave power output is reduced in stages over the first few minutes down to the next power level (600W). After a cooling period, the microwave boost option will be available once more.

N50 Single Ovens

- Dial Control & LCD Screen on all models
- All ovens feature Circo Therm®

60CM SLIDE & HIDE® SINGLE OVEN			
PYROLYTIC/FIXED HANDLE B6ACH7AG7B N50	PYROLYTIC/FIXED HANDLE B6ACH7AN7B N50	FIXED HANDLE B3ACE4AG3B N50	
<ul style="list-style-type: none"> • 8 functions • Electronic, LCD display 	<ul style="list-style-type: none"> • 8 functions • Electronic, LCD display 	<ul style="list-style-type: none"> • 7 functions • LCD display 	
<ul style="list-style-type: none"> • Fixed handle • Graphite Grey 	<ul style="list-style-type: none"> • Fixed handle • Stainless Steel 	<ul style="list-style-type: none"> • Fixed handle • Graphite Grey 	
			

	B6ACH7AG7B N50	B6ACH7AN7B N50	B3ACE4AG3B N50
OPERATION			
NEFF Design Retractable controls	•	•	•
CONTROLS			
Electronic control	•	•	
Temperature proposal with display	•/•	•/•	
Heating up indicator / Residual heat indicator	•/•	•/•	•/
Control panel lock / Safety switch off	•/•	•/•	•/
Automatic programmes			
SPECIAL FEATURES			
Door type	Slide & Hide® with Fixed Handle	Slide & Hide® with Fixed Handle	Slide & Hide® with Fixed Handle
Soft open door			
Oven Assistant with Voice Control			
NEFF Home Connect	•	•	
Telescopic Rail	Available as an accessory	Available as an accessory	Available as an accessory
Multi Point Temperature Probe			
Single Point Meat Probe			
Rapid heat up			
Baking and roasting assistant			
FEATURES			
Electronic clock / timer	White LCD Display	White LCD Display	White LCD Display
Full glass inner door	•	•	•
Glazed door (Quadruple / Triple / Double)	Quadruple	Quadruple	Triple
Internal lighting	1 x 25W Halogen	1 x 25W Halogen	1 x 25W Halogen
Water tank empty indicator			
COOKING FUNCTIONS			
Circo Therm®	8	8	7
Circo Therm® Gentle / Top/bottom heat Gentle	3D	3D	3D
Top/bottom heat / Bottom heat	•/•	•/•	•/•
Circo Roasting	•	•	•
Full surface grill/ Centre Surface Grill	•/	•/	•/
Bread baking	•	•	
Low temperature cooking			
Pizza setting/ Circo Therm® Intensive	•	•	•
Defrost			
Dough Proving			
Plate warming/ Keep Warm			
OVEN CLEANING			
Pyrolytic cleaning	•	•	
Easy Clean® / Base Clean	•/	•/	•/
Eco Clean Surface			back
Cleaning setting	•	•	
Descaling programme			
STANDARD ACCESSORIES			
Universal pan	1	1	1
Steam Container			
Wire shelf	2	2	2
ENERGY EFFICIENCY¹			
Energy efficiency class	A+	A+	A+
Energy consumption per cycle Circo Therm® kWh	0.81	0.81	0.81
Energy consumption per cycle conventional kWh	1.04	1.04	1.04
Oven capacity L	71	71	71
Time to cook standard load mins	58	58	58
Largest baking sheet area cm ²	1290	1290	1290
TECHNICAL INFORMATION			
Total connected load kW	2.9	2.9	2.9

60CM SLIDE & HIDE® SINGLE OVEN		60CM SINGLE OVEN - DROP DOWN DOOR	
FIXED HANDLE B3ACE4AN3B N50	ROTATING HANDLE B4ACF1AN3B N50	PYROLYTIC B2ACH7AG7B N50	B1ACE4AG3B N50
<ul style="list-style-type: none"> • 7 functions • LCD display 	<ul style="list-style-type: none"> • 6 functions • LCD display 	<ul style="list-style-type: none"> • 8 functions • Electronic, LCD display 	<ul style="list-style-type: none"> • 6 functions • LCD display
<ul style="list-style-type: none"> • Fixed handle • Stainless Steel 	<ul style="list-style-type: none"> • Rotating handle • Stainless Steel 	<ul style="list-style-type: none"> • Graphite Grey 	<ul style="list-style-type: none"> • Graphite Grey
			

	B3ACE4AN3B N50	B4ACF1AN3B N50	B2ACH7AG7B N50	B1ACE4AG3B N50
OPERATION				
NEFF Design Retractable controls	•	•	•	•
CONTROLS				
Electronic control			•	
Temperature proposal with display			•/•	
Heating up indicator / Residual heat indicator	•/	•/	•/•	•/
Control panel lock / Safety switch off	•/	•/	•/•	•/
Automatic programmes				
SPECIAL FEATURES				
Door type	Slide & Hide® with Fixed Handle	Slide & Hide® with Rotating Handle	Drop Down Door	Drop Down Door
Soft open door				
Oven Assistant with Voice Control				
NEFF Home Connect			•	
Telescopic Rail	Available as an accessory	Available as an accessory	Available as an accessory	Available as an accessory
Multi Point Temperature Probe				
Single Point Meat Probe				
Rapid heat up				
Baking and roasting assistant				
FEATURES				
Electronic clock / timer	White LCD Display	White LCD Display	White LCD Display	White LCD Display
Full glass inner door	•	•	•	•
Glazed door (Quadruple / Triple / Double)	Triple	Triple	Quadruple	Double
Internal lighting	1 x 25W Halogen	1 x 25W Halogen	1 x 25W Halogen	1 x 25W Halogen
Water tank empty indicator				
COOKING FUNCTIONS				
Circo Therm®	7	6	8	6
Circo Therm® Gentle / Top/bottom heat Gentle	3D	3D	3D	3D
Top/bottom heat / Bottom heat	•/	•/	•/•	•/
Circo Roasting	•/•	•/•	•/•	•/
Full surface grill/ Centre Surface Grill	•	•	•	•
Bread baking	•/	•/	•/	•/
Low temperature cooking				
Pizza setting/ Circo Therm® Intensive	•	•	•	•
Defrost				
Dough Proving				
Plate warming/ Keep Warm				
OVEN CLEANING				
Pyrolytic cleaning			•	
Easy Clean® / Base Clean	•/		•/	•/
Eco Clean Surface	back	back	•	back
Cleaning setting			•	
Descaling programme				
STANDARD ACCESSORIES				
Universal pan	1	1	1	1
Steam Container				
Wire shelf	2	2	2	2
ENERGY EFFICIENCY¹				
Energy efficiency class	A+	A+	A+	A+
Energy consumption per cycle Circo Therm® kWh	0.81	0.81	0.81	0.81
Energy consumption per cycle conventional kWh	1.04	1.04	0.99	0.97
Oven capacity L	71	71	71	71
Time to cook standard load mins	58	58	50	44
Largest baking sheet area cm ²	1290	1290	1290	1290
TECHNICAL INFORMATION				
Total connected load kW	2.9	2.9	2.9	2.9

¹ Measured according to the EN50304, 65/2014. ² For further information on inverter technology, please go to www.neffhome.com/uk. ³ For Inverter models, the maximum setting offers a time limited boost option for heating liquids. To ensure optimal results and to protect the appliance, the microwave power output is reduced in stages over the first few minutes down to the next power level (600W). After a cooling period, the microwave boost option will be available once more.

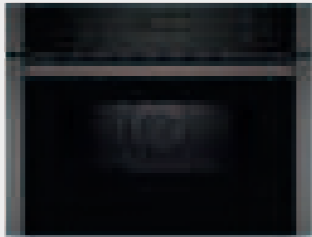
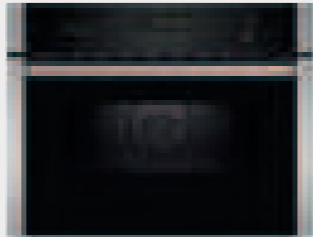

N50 Compact Ovens with Microwave

- Dial Control & LCD Screen on all models

45CM COMPACT OVENS		
	WITH MICROWAVE C1AMG84G1B N50	WITH MICROWAVE C1AMG84N1B N50
	<ul style="list-style-type: none"> • 3 functions • Electronic, LCD Display • MW & Oven with combination options • 15 automatic programmes • Graphite Grey 	<ul style="list-style-type: none"> • 3 functions • Electronic, LCD Display • MW & Oven with combination options • 15 automatic programmes • Stainless Steel
		

OPERATION		
Premium Full Touch TFT Display Type		
Screen Size		
NEFF Design Retractable controls	•	•
CONTROLS		
Electronic control	•	•
Temperature proposal with Display		
Heating up indicator/ Safety switch off	/•	/•
Automatic programmes	15	15
SPECIAL FEATURES		
NEFF Home Connect		
Door Type	Drop Down Door	Drop Down Door
Soft close / open door		
Telescopic Rail		
MultiPoint Temperature Probe		
Baking and roasting assistant		
FEATURES		
Display Type	White LCD display	White LCD display
Full glass inner door		
Glazed door (Quadruple/Triple/Double)	Triple	Triple
Internal lighting	1 x 1W LED	1 x 1W LED
COOKING FUNCTIONS		
Hot Air	•	•
Hot Air Gentle		
Top/bottom heat		
Conventional heat Eco		
Fan & Grill	•	•
Full surface grill/ Centre surface grill	•/	•/
Bread baking		
Bottom heat		
Low temperature cooking		
Pizza setting/ Circo Therm® Intensive	•	•
Defrost		
Dough Proving		
Plate warming/ Keep warm		
Microwave	•	•
Microwave combinable	•	•
OVEN CLEANING		
Pyrolytic cleaning		
Easy Clean®/ Base Clean		
Eco Clean Surfaces		
Cleaning setting		
STANDARD ACCESSORIES		
Wire shelf	1	1
Universal pan		
Ceramic Glass Base	•	•
STANDARD ACCESSORIES		
Energy efficiency index		
Energy efficiency class		
Energy consumption per cycle Circo Therm® kWh		
Energy consumption per cycle conventional kWh		
Oven capacity (L)	44	44
Time to cook standard load mins		
Largest baking sheet area cm²		
TECHNICAL INFORMATION		
Total connected load kW	3.3	3.3

N50 Compact Microwaves

38CM MICROWAVES			
	900W HLAWD53N0B N50	800W HLAWD23G0B N50	800W HLAWD23N0B N50
	<ul style="list-style-type: none"> • Up to 900W • 25L • 5 power levels • Electronic, white LED display • Stainless Steel 	<ul style="list-style-type: none"> • Up to 800W • 25L • 5 power levels • Electronic, white LED display • Graphite Grey 	<ul style="list-style-type: none"> • Up to 800W • 25L • 5 power levels • Electronic, white LED display • Stainless Steel
			

OPERATION			
Retractable control with push buttons	•	•	•
Control panel position	Right, vertical	Right, vertical	Right, vertical
FUNCTIONS			
Microwave	•	•	•
Quartz Grill			
Microwave & grill combination			
FEATURES			
Installation position	Tall housing	Wall unit or Tall housing	Wall unit or Tall housing
Full width frameless design	•	•	•
Electronic Clock	White LED display	White LED display	White LED display
ClearText Display			
Automatic programmes	7	7	7
Memory settings	1	1	1
Maximum cooking time duration (mins)	99	99	99
Electronic door opening			
Push button door opening	•	•	•
Hinge	Left	Left	Left
Internal light	1 x 3W LED	1 x 3W LED	1 x 3W LED
Stainless steel interior	•	•	•
STANDARD ACCESSORIES			
Glass turntable	1	1	1
Glass pan / Wire Grid			
TECHNICAL INFORMATION			
Appliance Dimensions HxWxD mm	382 x 594 x 388	382 x 594 x 317	382 x 594 x 317
Cavity Dimensions HxWxD mm	208 x 328 x 369	201 x 308 x 282	201 x 308 x 282
Oven capacity L	25	20	20
Inverter technology ²			
Maximum power Microwave ³ W	900	800	800
Number of Microwave power levels	5	5	5
Microwave distribution	Turntable	Turntable	Turntable
Turntable diameter mm	315	255	255
Total connected load kW	1.4	1.2	1.2
Minimum fuse protection Amps	10	10	10
Cable length cm	130	130	130
GB plug	•	•	•

N50 Double Ovens & Built-Under Double Ovens

- Dial Control & LCD Screen on all models
- All ovens feature a Circo Therm® Main Oven



DOUBLE OVENS

PYROLYTIC U2ACH7AG7B | N50

- 8 functions
- 2nd oven 4 functions
- Electronic, LCD display
- Pyrolytic for both ovens
- Graphite Grey

PYROLYTIC U2ACH7AN7B | N50

- 8 functions
- 2nd oven 4 functions
- Electronic, LCD display
- Pyrolytic for both ovens
- Stainless Steel



DOUBLE OVENS

U1ACE2AG3B | N50

- 5 functions
- LCD display
- 2nd oven 4 functions
- Graphite Grey

U1ACE2AN3B | N50

- 5 functions
- LCD display
- 2nd oven 4 functions
- Stainless Steel

BUILT-UNDER DOUBLE OVEN

J1ACE2HN0B | N50

- 6 functions
- LCD display
- 2nd oven 3 functions
- Stainless Steel

DESIGN	U2ACH7AG7B N50		U2ACH7AN7B N50	
NEFF Design Retractable controls	•	•	•	•
Electronic clock / timer	White LCD display		White LCD display	
ELECTRONIC CONTROL	Main	2nd	Main	2nd
Temperature display	•	•	•	•
Heating up indicator	•	•	•	•
Residual heat indicator	•	•	•	•
Temperature proposal	•	•	•	•
SPECIAL FEATURES	Main	2nd	Main	2nd
Door type	Drop Down Door	Drop Down Door	Drop Down Door	Drop Down Door
NEFF Home Connect	•	•	•	•
Electronic control	•	•	•	•
Telescopic Rails	Available as an accessory		Available as an accessory	
FEATURES	Main	2nd	Main	2nd
Control panel lock	•	•	•	•
Full glass inner door	•	•	•	•
Safety switch off	•	•	•	•
Internal lighting	1 x 25W halogen	1 x 25W halogen	1 x 25W halogen	1 x 25W halogen
Number of shelf positions	4	3	4	3
Glazed door (Quadruple/Triple/Double)	Quadruple	Quadruple	Quadruple	Quadruple
COOKING FUNCTIONS	Main	2nd	Main	2nd
Circo Therm®	3D		3D	
Circo Therm® Gentle	•		•	
Top/bottom heat	•	•	•	•
Circo Roasting	•		•	
Full surface grill	•	•	•	•
Centre surface grill		•		•
Bread baking	•		•	
Bottom heat	•	•	•	•
Pizza Setting / Circo Therm® Intensive	•		•	
Rapid heat	•		•	
OVEN CLEANING	Main	2nd	Main	2nd
Pyrolytic Cleaning	•	•	•	•
Easy Clean®	•		•	
Eco Clean liners (Roof/Back/Sides)				
Base clean				
Cleaning setting	•	•	•	•
STANDARD ACCESSORIES	Main	2nd	Main	2nd
Wire shelves	3		3	
Universal pan	1		1	
ENERGY EFFICIENCY¹	Main	2nd	Main	2nd
Energy efficiency index	95.3	120.3	95.3	120.3
Energy efficiency class	A	B	A	B
Energy consumption per cycle Circo Therm® (kWh)	0.75		0.75	
Energy consumption per cycle conventional (kWh)	1.00	0.83	1.00	0.83
Oven capacity (L)	71	34	71	34
Time to cook standard load (mins)	44	44	44	44
Largest baking sheet area (cm ²)	1290		1290	
TECHNICAL INFORMATION				
Total connected load kW	6.3		6.3	

DESIGN	U1ACE2AG3B N50		U1ACE2AN3B N50		J1ACE2HN0B N50	
NEFF Design Retractable controls	•	•	•	•	•	•
Electronic clock / timer	White LCD display		White LCD display		White LCD display	
ELECTRONIC CONTROL	Main	2nd	Main	2nd	Main	2nd
Temperature display	•		•		•	
Heating up indicator	•		•		•	
Residual heat indicator	•		•		•	
Temperature proposal	•		•		•	
SPECIAL FEATURES	Main	2nd	Main	2nd	Main	2nd
Door type	Drop Down Door	Drop Down Door	Drop Down Door	Drop Down Door	Drop Down Door	Drop Down Door
NEFF Home Connect	•		•		•	
Electronic control	•		•		•	
Telescopic Rails	Available as an accessory		Available as an accessory		Available as an accessory	
FEATURES	Main	2nd	Main	2nd	Main	2nd
Control panel lock	•		•		•	
Full glass inner door	•	•	•	•	•	•
Safety switch off	•		•		•	
Internal lighting	1 x 25W halogen	1 x 25W halogen	1 x 25W halogen	1 x 25W halogen	1 x 25W halogen	1 x 25W halogen
Number of shelf positions	4	3	4	3	3	3
Glazed door (Quadruple/Triple/Double)	Double	Double	Double	Double	Double	Triple
COOKING FUNCTIONS	Main	2nd	Main	2nd	Main	2nd
Circo Therm®	3D		3D		3D	
Circo Therm® Gentle	•		•		•	
Top/bottom heat	•	•	•	•	•	•
Circo Roasting	•		•		•	
Full surface grill	•	•	•	•	•	•
Centre surface grill		•		•		•
Bread baking	•		•		•	
Bottom heat	•	•	•	•	•	•
Pizza Setting / Circo Therm® Intensive	•		•		•	
Rapid heat	•		•		•	
OVEN CLEANING	Main	2nd	Main	2nd	Main	2nd
Pyrolytic Cleaning	•		•		•	
Easy Clean®	•		•		•	
Eco Clean liners (Roof/Back/Sides)						
Base clean						
Cleaning setting	•		•		•	
STANDARD ACCESSORIES	Main	2nd	Main	2nd	Main	2nd
Wire shelves	3		3		2	
Universal pan	1		1		1	
ENERGY EFFICIENCY¹	Main	2nd	Main	2nd	Main	2nd
Energy efficiency index	95.3	120.3	95.3	120.3	94.7	120.3
Energy efficiency class	A	B	A	B	A	B
Energy consumption per cycle Circo Therm® (kWh)	0.75		0.75		0.64	
Energy consumption per cycle conventional (kWh)	1.00	0.83	1.00	0.83	0.84	0.83
Oven capacity (L)	71	34	71	34	47	34
Time to cook standard load (mins)	44	44	44	44	45	45
Largest baking sheet area (cm ²)	1290		1290		1290	
TECHNICAL INFORMATION						
Total connected load kW	5.9		5.9		5.3	

¹ Measured according to the EN50304, 65/2014. ² For further information on inverter technology, please go to www.neffhome.com/uk. ³ For inverter models, the maximum setting offers a time limited boost option for heating liquids. To ensure optimal results and to protect the appliance, the microwave power output is reduced in stages over the first few minutes down to the next power level (600W). After a cooling period, the microwave boost option will be available once more.

Warming Drawers & Accessory

	29CM WARMING DRAWERS		14CM WARMING DRAWERS
	N34HA11G1B N90 / N70	N34HA11N1B N90 / N70	N24HA11G1B N90 / N70
	<ul style="list-style-type: none"> • 29cm high • Electronic touch control warming drawer • 4 settings or 6 selectable temperature settings • Timer • Heated ceramic base • Push/pull opening • Graphite Grey 	<ul style="list-style-type: none"> • 29cm high • Electronic touch control warming drawer • 4 settings or 6 selectable temperature settings • Timer • Heated ceramic base • Push/pull opening • Stainless Steel 	<ul style="list-style-type: none"> • 14cm high • Electronic touch control warming drawer • 4 settings or 6 selectable temperature settings • Timer • Heated ceramic base • Push/pull opening • Graphite Grey
FUNCTIONS			
Plate warming	•	•	•
Hold Warm	•	•	•
Defrost	•	•	•
Low temperature cooking	•	•	•
Accessory drawer			
FEATURES			
NEFF Home Connect	•	•	•
Operating indicator light	•	•	•
Electronic control	•	•	•
Rotary temperature control dial			
Touch control	•	•	•
Number of temperature settings	4	4	4
Maximum temperature	80	80	80
Minimum temperature	30	30	30
Ceramic Glass Base	•	•	•
DESIGN			
Install independently	•	•	•
Install with compact appliance	N70 / N90	N70 / N90	N70 / N90
Install with a single oven	N70 / N90	N70 / N90	N70 / N90
Push-Pull opening mechanism	•	•	•
TECHNICAL INFORMATION			
Drawer interior volume	L 54	54	20
Interior drawer dimensions HxWxD	mm 290x594x518mm	290x594x518mm	140x594x518
Vacuum chamber dimensions HxWxD	mm		
Installation in tall housing or under work surface	•	•	•
Maximum weight capacity	25	25	25
Total connected loading	kW 0.82	0.82	0.82
Minimum fuse rating	10	10	10
Cable length	175	175	170
GB plug	•	•	•
STANDARD ACCESSORIES			
Vacuums platform			
External vacuuming adaptor, hose & plugs			
Sample vacuuming bags			
Antislip mat			



	14CM WARMING DRAWERS	29CM WARMING DRAWERS	14CM WARMING DRAWERS	
	N24HA11N1B N90 / N70	N1AHA02N0B N50	N1AHA01G0B N50	N1AHA01N0B N50
	<ul style="list-style-type: none"> • 14cm high • Electronic touch control warming drawer • 4 settings or 6 selectable temperature settings • Timer • Heated ceramic base • Push/pull opening • Stainless Steel 	<ul style="list-style-type: none"> • 29cm high • Warming drawer • 3 settings • Push-pull opening • Stainless Steel 	<ul style="list-style-type: none"> • 14cm high • Warming drawer • 3 settings • Push-pull opening • Graphite Grey 	<ul style="list-style-type: none"> • 14cm high • Warming drawer • 3 settings • Push-pull opening • Stainless Steel
FUNCTIONS				
Plate warming	•	•	•	•
Hold Warm	•	•	•	•
Defrost	•	•	•	•
Low temperature cooking	•			
Accessory drawer				
FEATURES				
NEFF Home Connect	•			
Operating indicator light	•	•	•	•
Electronic control	•			
Rotary temperature control dial				
Touch control	•			
Number of temperature settings	4	3	3	3
Maximum temperature	80	80	80	80
Minimum temperature	30	40	40	40
Ceramic Glass Base	•			
DESIGN				
Install independently	•	•	•	•
Install with compact appliance	N70 / N90	N50	N50	N50
Install with a single oven	N70 / N90	N50	N50	N50
Push-Pull opening mechanism	•	•	•	•
TECHNICAL INFORMATION				
Drawer interior volume	L 20	58	23	23
Interior drawer dimensions HxWxD	mm 140x594x518	250x475x490	100x475x490	100x475x490
Vacuum chamber dimensions HxWxD	mm			
Installation in tall housing or under work surface	•	•	•	•
Maximum weight capacity	25	15	15	15
Total connected loading	kW 0.82	0.40	0.40	0.40
Minimum fuse rating	10	6	6	6
Cable length	170	150	150	150
GB plug	•	•	•	•
STANDARD ACCESSORIES				
Vacuums platform				
External vacuuming adaptor, hose & plugs				
Sample vacuuming bags				
Antislip mat		•	•	•

Wireless MultiPoint Meatprobe

- Four sensors measure the foods core temperature for ultra precise cooking.
- NEFF Home Connect App lets you know when your desired doneness level has been reached.
- The wireless meat probe turns on when it is connected to your NEFF oven via NEFF Home Connect. Once the desired temperature is detected, the probe will send a signal to the oven, causing it to switch off automatically.
- Use it in your oven, on your hob, or outside on your grill.



Z1365WX0

FUNCTIONS	
Dimensions	150x19x52mm
Finish	Stainless steel
Dishwasher Safe	•
Suitable for steaming	•

1 Measured according to the EN50304, 65/2014. 2 For further information on inverter technology, please go to www.neffhome.com/uk. 3 For Inverter models, the maximum setting offers a time limited boost option for heating liquids. To ensure optimal results and to protect the appliance, the microwave power output is reduced in stages over the first few minutes down to the next power level (600W). After a cooling period, the microwave boost option will be available once more.

Create a sleek and stylish finish with Seamless Combinations

NEFF allows you the freedom to choose the appliances that suit your cooking style – and when it comes to design within our N90 & N70 Slide & Hide® 60cm single ovens and the majority of our 45cm compact ovens you can install a seamless look.

N90 and N70 Graphite Grey

Seamless Combination® strips – Z11SZ60G0
For 45cm Compact Oven with 14cm Warming Drawer



Seamless Combination® strips – Z11SZ80G0
For 60cm Single Slide & Hide® Oven with 29cm Warming Drawer



Seamless Combination® strips – Z11SZ90G1
For 60cm Single Slide & Hide® Oven with 45cm Compact Oven (special aperture applies)



Black Cosmetic Decor strip – Z13CV06S0
For use between 60cm single and 45cm compact ovens



Compact Oven – C24MS71G0B
Compact Pyrolytic Oven with Microwave and a Full Touch 2 display



Warming Drawer – N24HA11G1B
N70 / N90

Single Oven – B64VS71G0B
Slide & Hide® Single Oven with Pyrolytic, Vario Steam® and a Full Touch 2 display



Warming Drawer – N34HA11G1B
Warming Drawer N90 / N70

Compact Oven – C24MS31G0B
Compact Steam Oven with Intensive Steam and a Full Touch 2 display



Single Oven – B64FS31G0B
Slide & Hide® Single Oven with Intensive Steam and a Full Touch 2 display

Mix and match your appliances

You can combine single ovens with a Slide & Hide® door in the N90 & N70 range.

It is not possible to seamlessly combine any models in this value class with a drop-down door. It is also not possible to combine the N50 range seamlessly – this is due to where the fixing points are on the appliance.

The N90 & N70 Range combinations, illustrated below, are:

- 45cm Compact oven* with a 14cm warming drawer.
- 60cm Single Slide & Hide® oven with a 29cm warming drawer.
- 45cm Compact oven* with a 60cm Single Slide & Hide® oven.
- Possible in Graphite Grey & Stainless Steel trim colour.

* This cannot be done on the following C24GR3XG1B or CL4T11G0.

N70 Stainless Steel

Seamless Combination® strips – Z11SZ60X0
For 45cm Compact Oven with 14cm Warming Drawer



Seamless Combination® strips – Z11SZ80X1
For 60cm Single Slide & Hide® Oven with 29cm Warming Drawer



Seamless Combination® strips – Z11SZ90X1
For 60cm Single Slide & Hide® Oven with 45cm Compact Oven (special aperture applies)

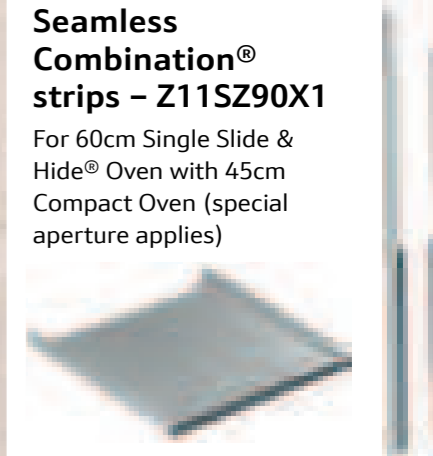

Compact Oven – C24MR21N0B
Compact Oven with Microwave and a Full Touch 1 display



Warming Drawer – N24HA11N1B
Warming Drawer N70 / N90

Single Oven – B54CR31N0B
Single Oven with a Full Touch 1 display

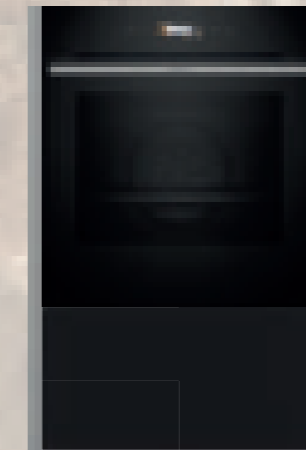

Warming Drawer – N34HA11N1B
Warming Drawer N90 / N70

Compact Oven – C24MR21N0B
Compact Oven with Microwave and a Full Touch 1 display

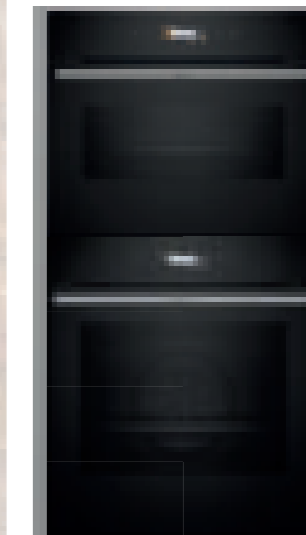

Single Oven – B54CR71N0B
Slide & Hide® Single Pyrolytic Oven with Full Touch 1 display

Core Range N90 60cm Single Ovens with Steam

B64VS71G0B, B64FS31G0B,

Installing two appliances on top of each other
 21
 18
 525
 548
 17.5
 max. 487.5

If the appliance will be installed in a cabinet, the following minimum clearances (including countertop thickness) must be maintained:

Min. gap	Min. working distance	
	Top	Side
Between top	51 mm	50 mm
Between side	41 mm	40 mm
Between top	50 mm	40 mm
Between side	50 mm	40 mm

measurements in mm

A: Air inlet ≥ 200 cm²

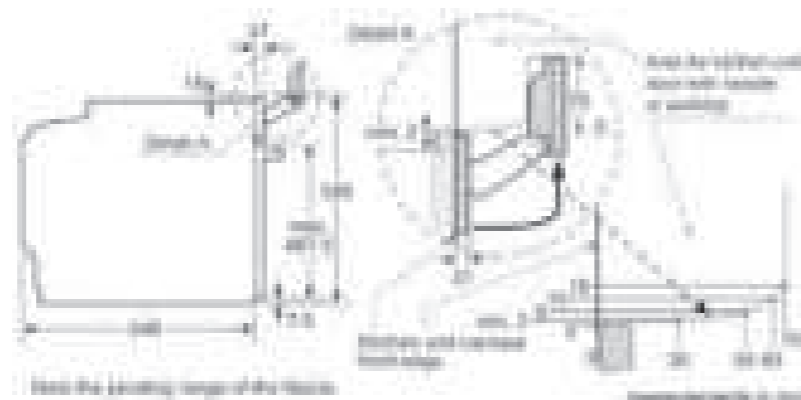
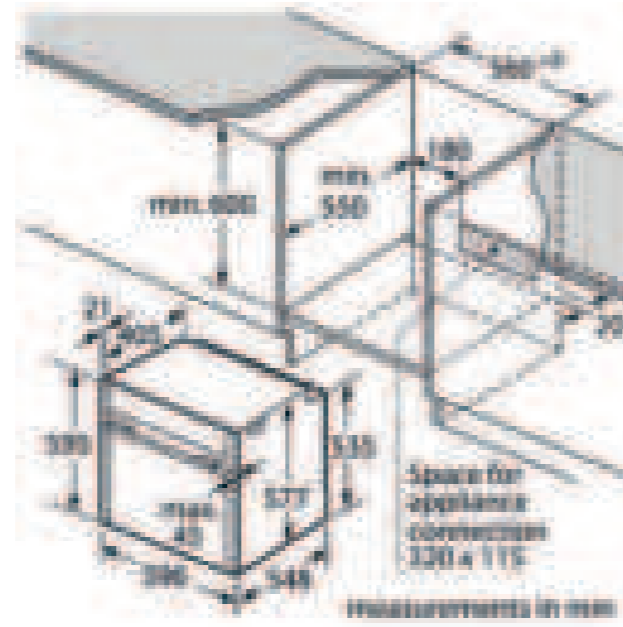
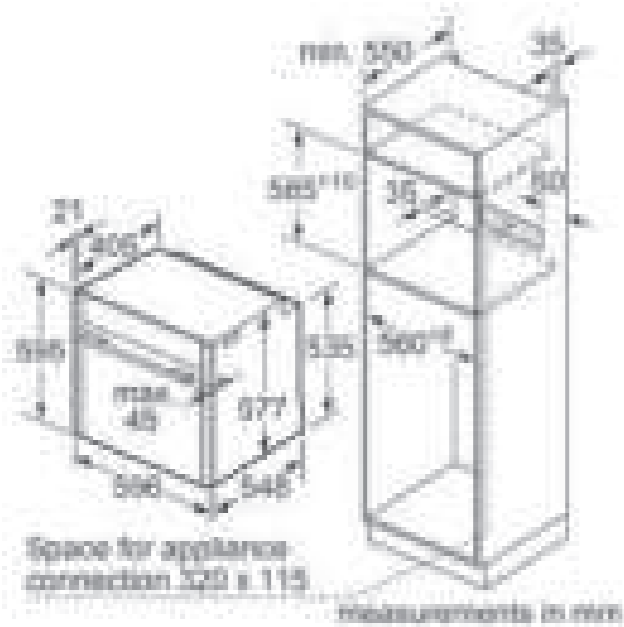

Measurements in mm. The line drawings featured in this brochure are provided as a guide to general dimensions only and are subject to amendment without prior notice. For full dimensional and installation details please refer to the documentation supplied with the appliance.

Core Range N90 / N70 60cm Single Ovens

B64CS71G0B, B54CR71G0B, B54CR71N0B, B54CR31G0B, B54CR31N0B

Installing two appliances on top of each other
 21
 18
 525
 548
 17.5
 max. 487.5

If the appliance will be installed in a cabinet, the following minimum clearances (including countertop thickness) must be maintained:

Min. gap	Min. working distance	
	Top	Side
Between top	51 mm	50 mm
Between side	41 mm	40 mm
Between top	50 mm	40 mm
Between side	50 mm	40 mm

measurements in mm

A: Air inlet ≥ 200 cm²

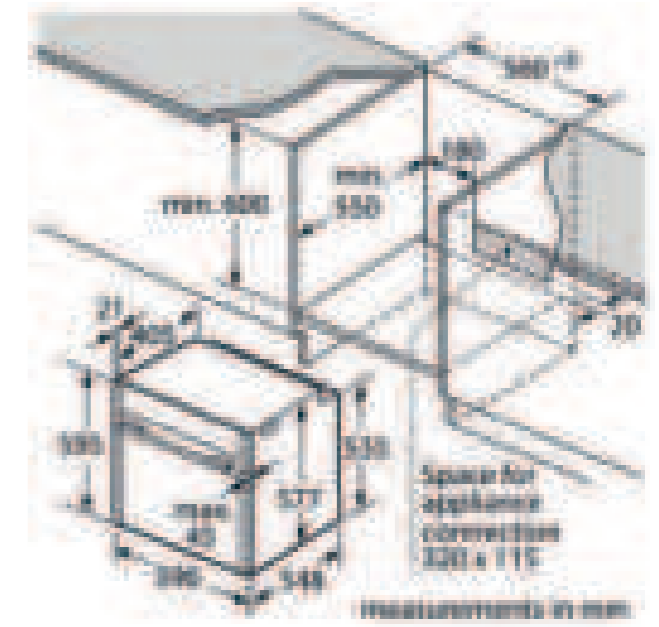
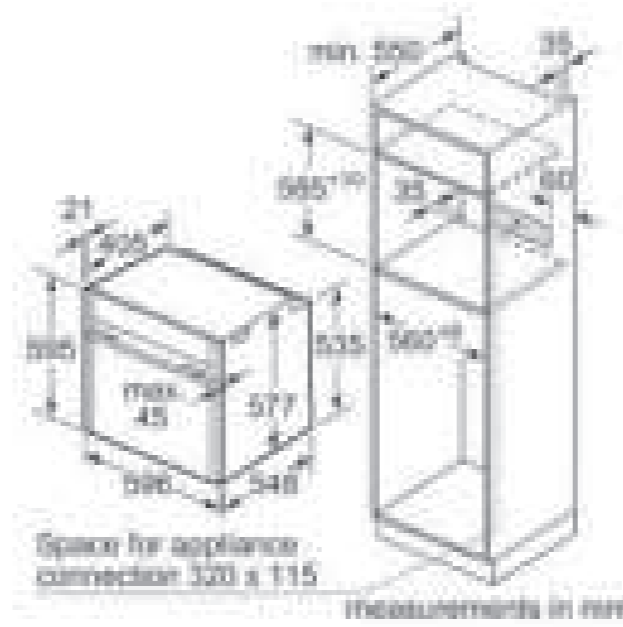

Measurements in mm. The line drawings featured in this brochure are provided as a guide to general dimensions only and are subject to amendment without prior notice. For full dimensional and installation details please refer to the documentation supplied with the appliance.

Core Range N50 60cm Single Ovens

B6ACH7AG7B, B6ACH7AN7B, B3ACE4AG3B, B3ACE4AN3B, B4ACF1AN3B, B2ACH7AG7B, B1ACE4AG3B



A: Air inlet ≥ 200 cm²

Measurements in mm

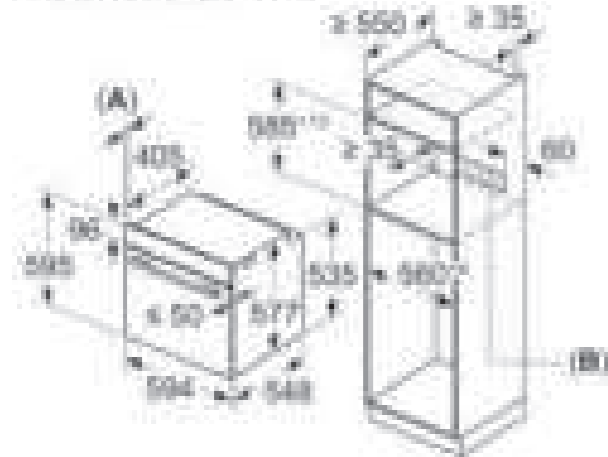

A: 19.5 mm
B: Space for appliance connection 320 x 115 mm

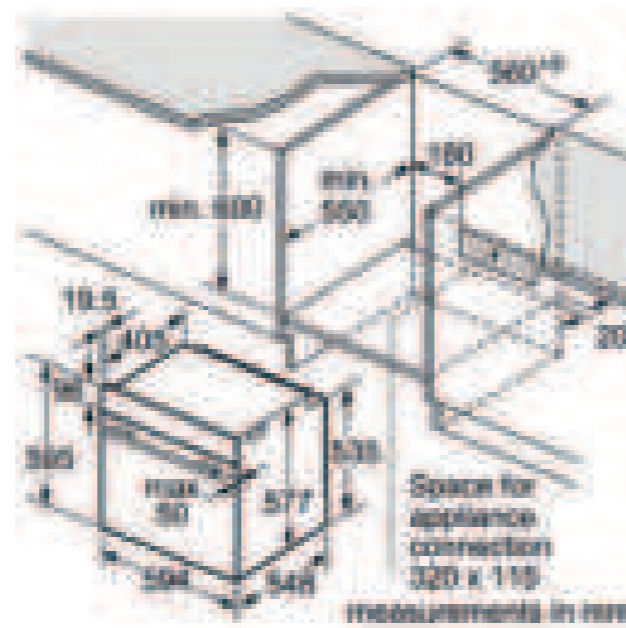

Core Range N50 Double Ovens

U2ACH7AG7B, U2ACH7AN7B, U1ACE2AG3B, U1ACE2AN3B

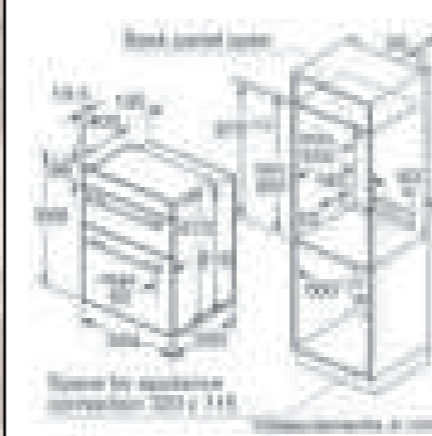

Measurements in mm

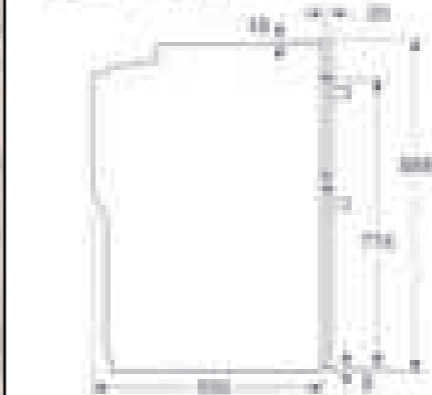

J1ACE2HN0B

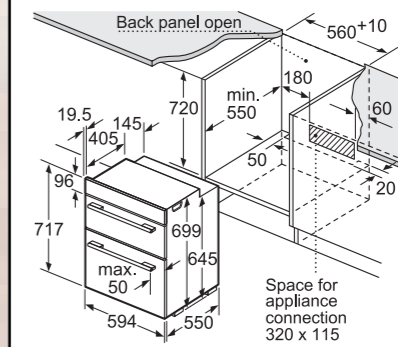

If the appliance will be installed underneath a hob, the following worktop thicknesses (including substructure if necessary) must be taken into account.

Hob type	min. worktop thickness	
	fit	flush
Induction hob	39 mm	40 mm
Full surface induction hob	49 mm	50 mm
Gas hob	29 mm	40 mm
Electric hob	29 mm	32 mm

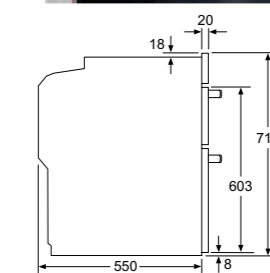
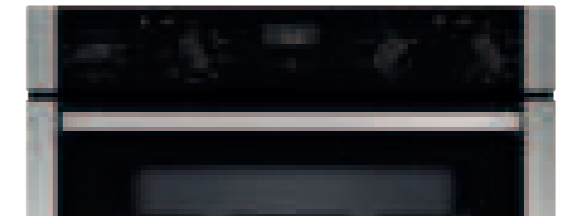

Core Range N90 45cm Compact Ovens with Steam

Core Range N90 / N70 45cm Compact Ovens with Microwave Function

C24FS31G0B

Installing oven appliances on top of each other
 20mm
 20mm
 20mm

Installation with a hob

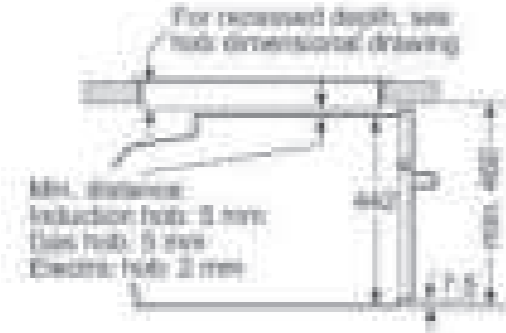
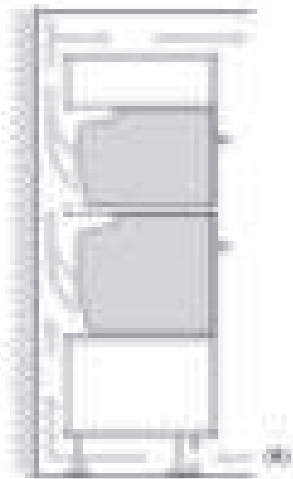

For recessed depth, see hob dimensional drawing
 For full dimensional details of the hob, please refer to the documentation supplied with the hob.
 For full dimensional details of the oven, please refer to the documentation supplied with the oven.

Hob type	Min. distance	Max. distance
Induction hob	2 mm	45 mm
Gas hob	5 mm	45 mm
Electric hob	2 mm	45 mm

Measurements in mm

A: Air Inlet $\geq 200 \text{ cm}^2$

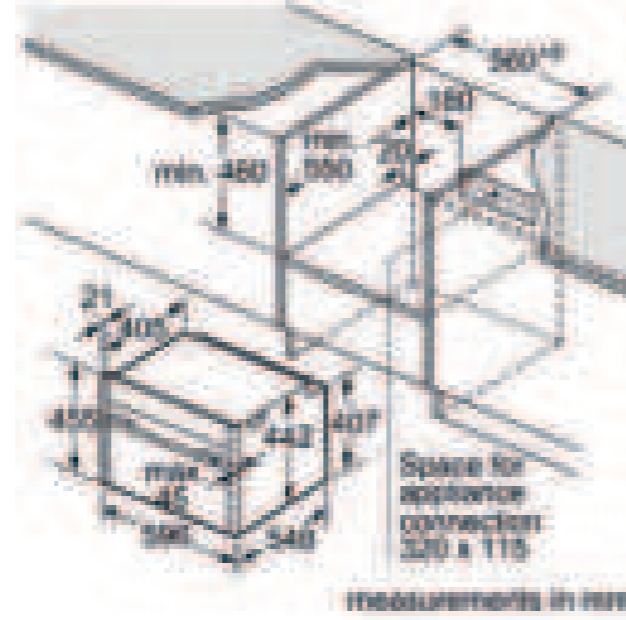
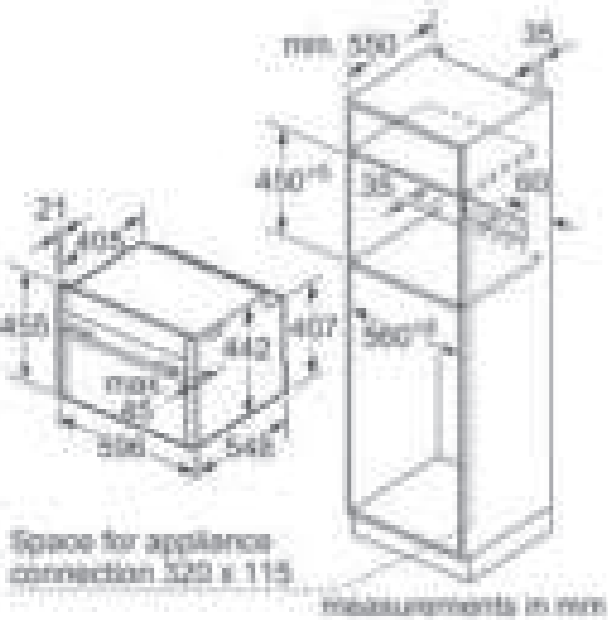

Space for appliance connection 320 x 115

Measurements in mm

Space for appliance connection 320 x 115

Measurements in mm

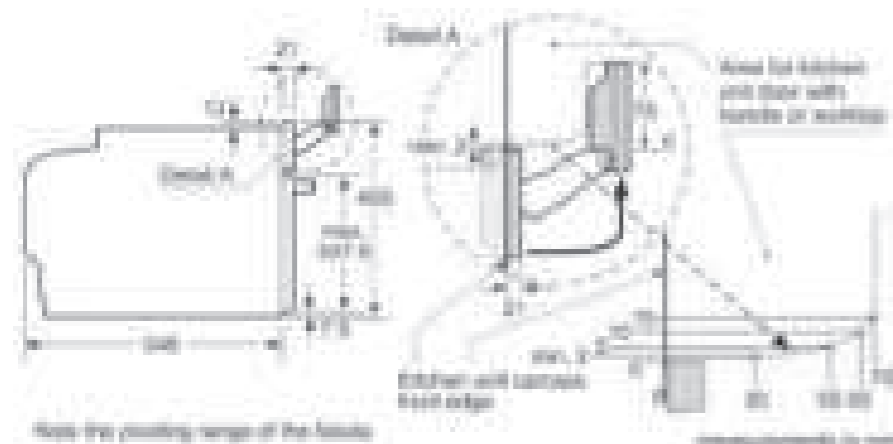

Note the mounting range of the hob.

Measurements in mm

C24MS71G0B, C24MS31G0B, C24MR21G0B, C24MR21N0B, C24GR3XG1B

Installing oven appliances on top of each other
 20mm
 20mm
 20mm

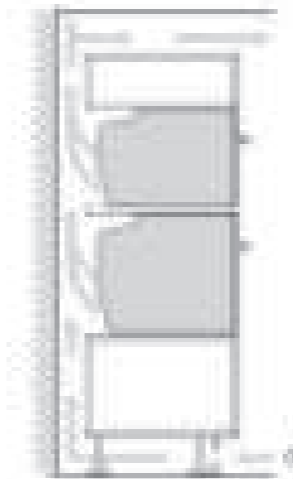

For recessed depth, see hob dimensional drawing
 For full dimensional details of the hob, please refer to the documentation supplied with the hob.
 For full dimensional details of the oven, please refer to the documentation supplied with the oven.

Hob type	Min. distance	Max. distance
Induction hob	2 mm	45 mm
Gas hob	5 mm	45 mm
Electric hob	2 mm	45 mm

Measurements in mm

A: Air Inlet $\geq 200 \text{ cm}^2$

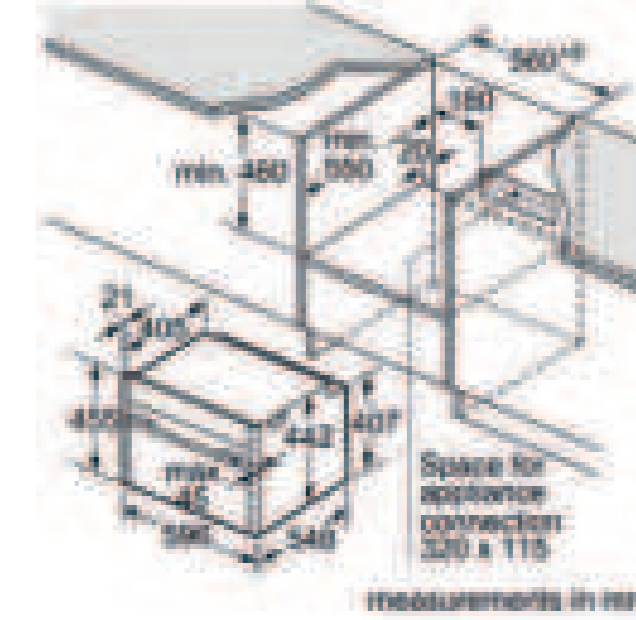
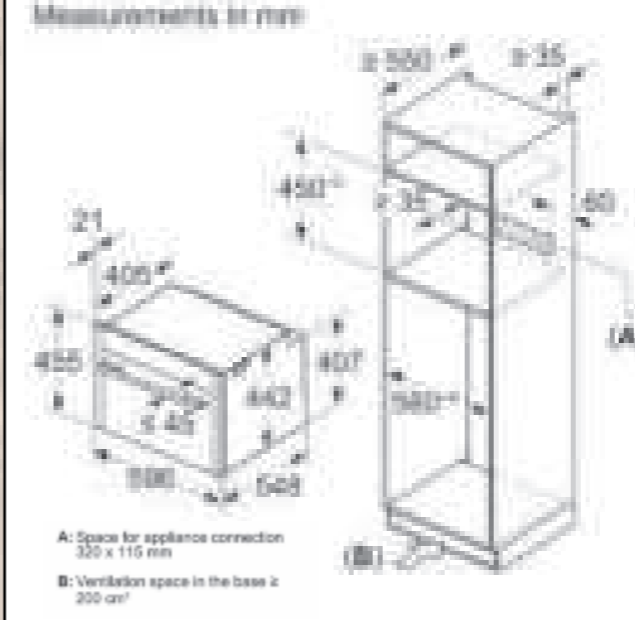

A: Space for appliance connection 320 x 115 mm
 B: Ventilation space in the base $\geq 200 \text{ cm}^2$

Space for appliance connection 320 x 115

Measurements in mm

Installation with a hob



Min. distance:
 Induction hob: 2 mm
 Gas hob: 5 mm
 Electric hob: 2 mm

Measurements in mm

Core Range N90 45cm Coffee Machine

CL4TT11G0

Measurements in mm



A: 7.5 mm

Measurements in mm

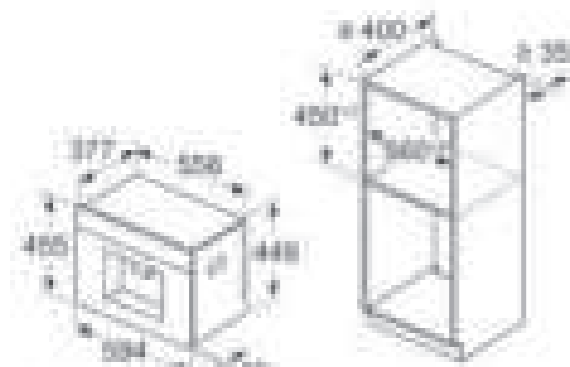

Beer and water containers are removed from the front
Recommended installation height: 850-1450 mm

Measurements in mm

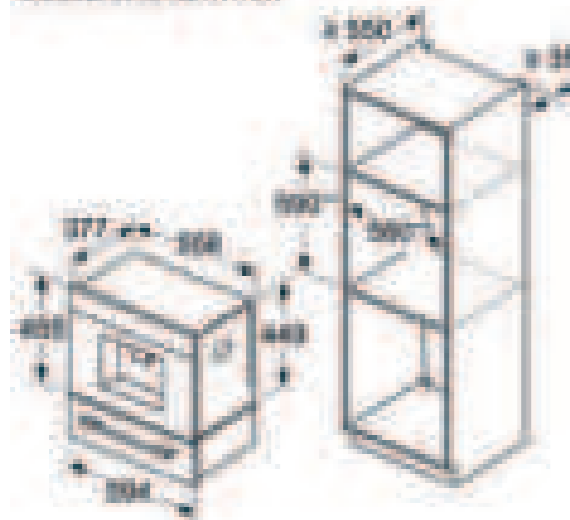

Measurements in mm

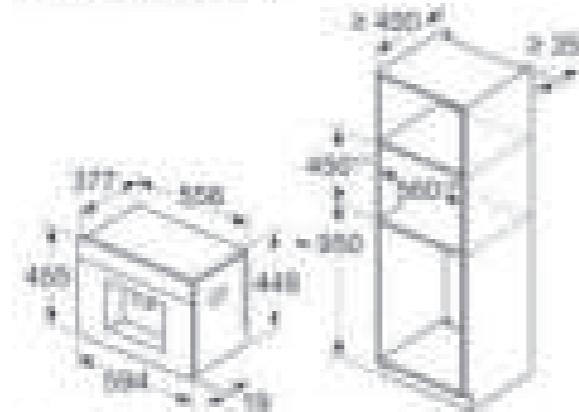

Beer and water containers are removed from the front
Recommended installation height: 850-1450 mm

Measurements in mm
Left corner installation

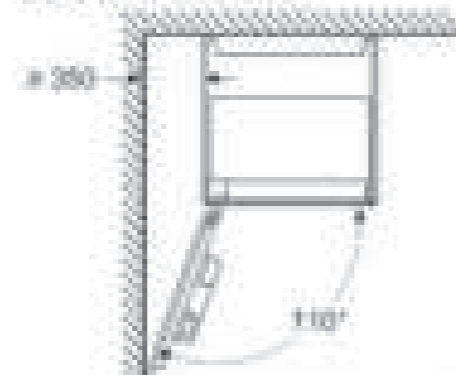

If using the 92° hinge bracket, the min. distance to the wall is only 100 mm

Core Range N50 45cm Microwave Ovens

C1AMG84G1B, C1AMG84N1B

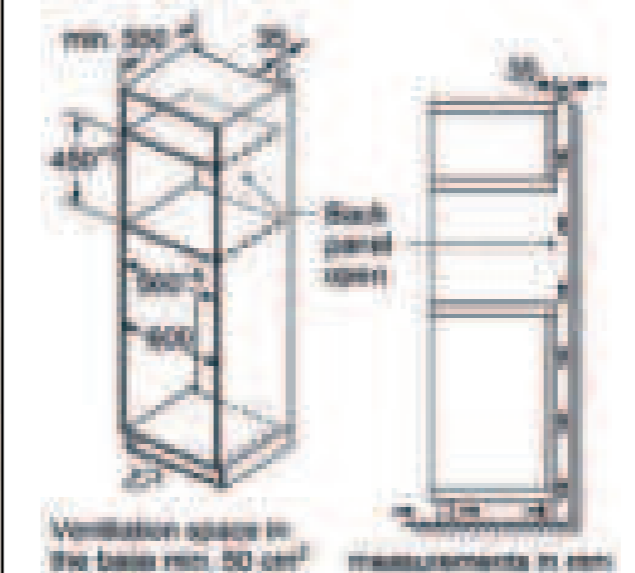
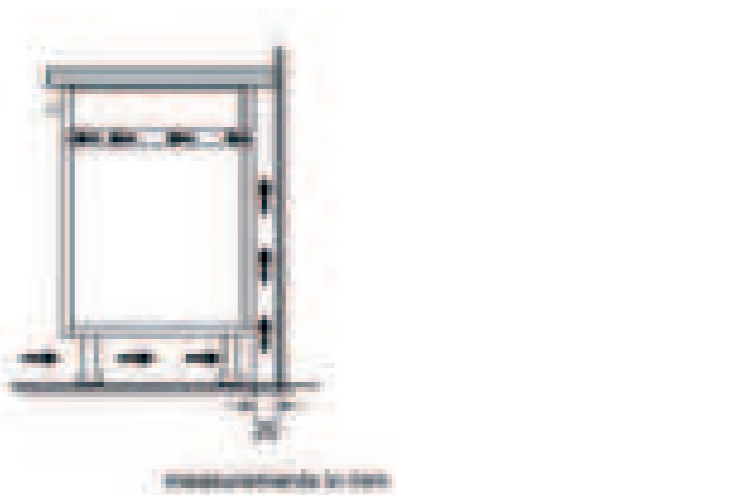
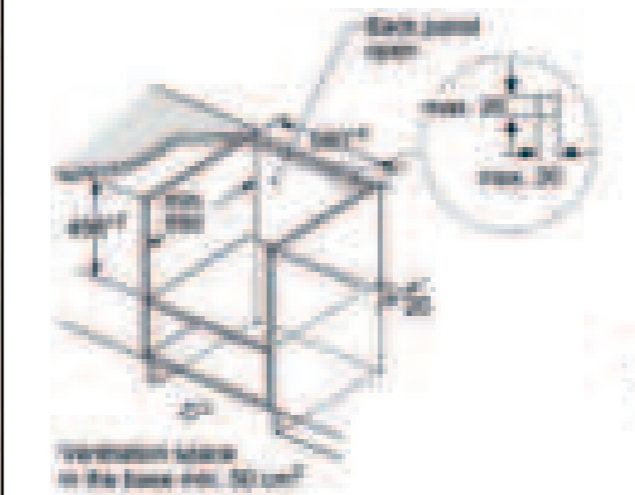
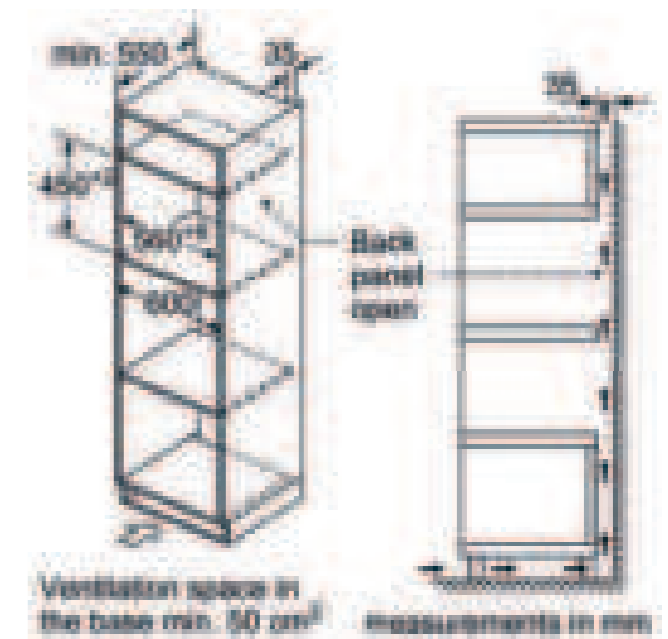
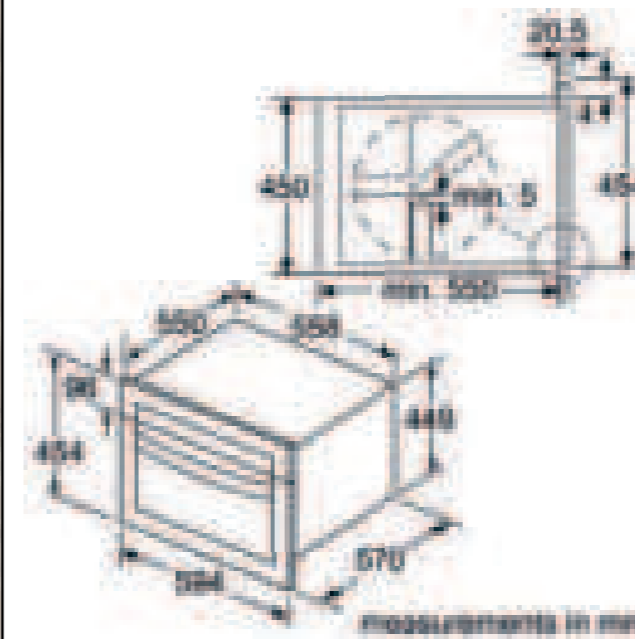

Measurements in mm. The line drawings featured in this brochure are provided as a guide to general dimensions only and are subject to amendment without prior notice. For full dimensional and installation details please refer to the documentation supplied with the appliance.

Measurements in mm. The line drawings featured in this brochure are provided as a guide to general dimensions only and are subject to amendment without prior notice. For full dimensional and installation details please refer to the documentation supplied with the appliance.

Core Range N70 / N50 38cm Microwave Ovens

NL4WR21G1B, NR4WR21G1B

Measurements in mm

Measurements in mm

Measurements in mm

A. Clearing of top: 20 mm
B. Clearing of bottom: 14 mm

Core Range Warming Drawers

N34HA11G1B, N34HA11N1B

Measurements in mm

Measurements in mm

Measurements in mm

A. 20 mm gap
Ovens with an appliance height of 455 mm can be installed above a warming drawer. An intermediate floor is not required.

HLAWD53N0B, HLAWD23G0B, HLAWD23N0B

Measurements in mm

Measurements in mm

20 mm gap for metal bases

Measurements in mm

Measurements in mm

Measurements in mm

Measurements in mm

20 mm gap for metal bases

Measurements in mm

N24HA11G1B, N24HA11N1B

Measurements in mm

Measurements in mm

20 mm gap for metal bases

N1AHA02N0B

Measurements in mm

Measurements in mm

20 mm gap for metal bases

Ovens with an appliance height of 595 mm can be installed above a warming drawer. An intermediate floor is not required.

N1AHA01N0B, N1AHA01G0B

Measurements in mm

Measurements in mm

20 mm gap for metal bases

Compact ovens with an appliance height of 455 mm can be installed above a warming drawer. An intermediate floor is not required.

Measurements in mm. The line drawings featured in this brochure are provided as a guide to general dimensions only and are subject to amendment without prior notice. For full dimensional and installation details please refer to the documentation supplied with the appliance.

Measurements in mm. The line drawings featured in this brochure are provided as a guide to general dimensions only and are subject to amendment without prior notice. For full dimensional and installation details please refer to the documentation supplied with the appliance.

Core Range Ovens - N90 / N70 Graphite Grey Trim

N90 - FULL TOUCH 3 - 6.8" FULL TOUCH TFT DISPLAY.

Collection	Display Size	Oven Description	No of Functions	Steam	Model Code
N90	Full Touch 3	Compact 45cm Coffee Machine	11		CL4TT11G0

N90 - FULL TOUCH 2 - 4.1" FULL TOUCH TFT DISPLAY

Collection	Display Size	Oven Description	No of Functions	Steam	Model Code
N90	Full Touch 2	Slide & Hide® Single Oven with Intensive Steam	22	Intensive	B64FS31G0B
N90	Full Touch 2	Slide & Hide® Single Pyrolytic Oven with Vario Steam®	20	Vario Steam®	B64VS71G0B
N90	Full Touch 2	Slide & Hide® Single Pyrolytic Oven	14		B64CS71G0B
N90	Full Touch 2	Compact Steam Oven	22	Intensive	C24FS31G0B
N90	Full Touch 2	Compact Oven with Microwave	20		C24MS31G0B
N90	Full Touch 2	Compact Pyrolytic Oven with Microwave	20		C24MS71G0B

N70 - FULL TOUCH 1 - 3.7" FULL TOUCH TFT DISPLAY

Collection	Display Size	Oven Description	No of Functions	Steam	Model Code
N70	Full Touch 1	Slide & Hide® Single Pyrolytic Oven	14		B54CR71G0B
N70	Full Touch 1	Slide & Hide® Single Oven	14		B54CR31G0B
N70	Full Touch 1	Compact Oven with Microwave	20		C24MR21G0B
N70	Full Touch 1	Compact Oven with Microwave	20		C24GR3XG1B
N70	Full Touch 1	Microwave Only - Up to 900W, 21 Litre - Left Hinged Door			NL4WR21G1B
N70	Full Touch 1	Microwave Only - Up to 900W, 21 Litre - Right Hinged Door			NR4WR21G1B

N90/N70 DRAWER RANGE

Collection	Drawer Range	Model Code
N90/70	29cm Warming Drawer	N34HA11G1B
N90/70	14cm Warming Drawer	N24HA11G1B

CORE RANGE SEAMLESS COMBINATION STRIPS - GRAPHITE GREY

Collection	Drawer Range	Model Code
N90/70	2 x 105cm Side Strips, Metal Platform & Brackets to install an N90 or an N70 single oven with a 45cm compact oven in column. (Single aperture required.) * Code Change November 2025 - Z11SZ90G1. New Design intermediate platform.	Z11SZ90G1
N90/70	2 x 90cm Side Strips to install an N90 or an N70 single oven with a 29cm warming drawer in column.	Z11SZ80G0
N90/70	2 x 60cm Side Strips to install an N90 or an N70 compact oven with a 14cm drawer in column.	Z11SZ60G0
N90/70/50	Black Cosmetic Decor strip for use between 60cm single and 45cm compact ovens	Z13CV06S0

Core Range Ovens - N70 Stainless Steel Trim

N70 - FULL TOUCH 1 - 3.7" FULL TOUCH TFT DISPLAY

Collection	Display Size	Oven Description	No of Functions	Steam	Model Code
N70	Full Touch 1	Slide & Hide® Single Pyrolytic Oven	14		B54CR71N0B
N70	Full Touch 1	Slide & Hide® Single Oven	14		B54CR31N0B
N70	Full Touch 1	Compact Oven with Microwave	20		C24MR21N0B

N70 DRAWER RANGE

Collection	Drawer Range	Model Code
N70	29cm Warming Drawer	N34HA11N1B
N70	14 cm Warming Drawer	N24HA11N1B

CORE RANGE SEAMLESS COMBINATION STRIPS - STAINLESS STEEL

Collection	Drawer Range	Model Code
N70	2 x 105cm Side Strips, Metal Platform & Brackets to install an N90 or an N70 single oven with a 45cm Compact oven in column. (Single aperture required.) * Code Change November 2025 - Z11SZ90X1. New Design Intermediate platform.	Z11SZ90X1
N70	2 x 90cm Side Strips to install an N90 or an N70 single oven with a 29cm warming drawer in column.	Z11SZ80X1
N70	2 x 60cm Side Strips to install an N90 or an N70 compact oven with a 14cm drawer in column.	Z11SZ60X0



Core Range Ovens - N50

NEFF N50 OVENS WITH SLIDE & HIDE® DOOR						
Collection	Display Size	Oven Description	No of Functions	Colour	NEFF Home Connect	Model Code
N50	LCD Display	Slide & Hide® Single Pyrolytic Ovens	8	Graphite Grey	Yes	B6ACH7AG7B
N50	LCD Display	Slide & Hide® Single Pyrolytic Ovens	8	Stainless Steel	Yes	B6ACH7AN7B
N50	LCD Display	Slide & Hide® Single Ovens	7	Graphite Grey		B3ACE4AG3B
N50	LCD Display	Slide & Hide® Single Ovens	7	Stainless Steel		B3ACE4AN3B
N50	LCD Display	Slide & Hide® Single Ovens	6	Graphite Grey		B4ACF1AN3B

NEFF N50 OVENS WITH DROP DOWN DOOR						
Collection	Display Size	Oven Description	No of Functions	Colour	NEFF Home Connect	Model Code
N50	LCD Display	Single Pyrolytic Ovens	8	Graphite Grey	Yes	B2ACH7AG7B
N50	LCD Display	Single Ovens	6	Graphite Grey		B1ACE4AG3B

NEFF N50 COMPACT OVENS & MICROWAVES						
Collection	Display Size	Oven description	No of Functions	Colour	NEFF Home Connect	Model Code
N50	LCD Display	Compact 45cm Microwave Combination Ovens	3	Graphite Grey		C1AMG84G1B
N50	LCD Display	Compact 45cm Microwave Combination Ovens	3	Stainless Steel		C1AMG84N1B
N50	White LCD Display	Microwave Ovens	5	Stainless Steel		HLAWD53N0B
N50	White LCD Display	Microwave Ovens	5	Graphite Grey		HLAWD23G0B
N50	White LCD Display	Microwave Ovens	5	Stainless Steel		HLAWD23N0B

N50 DOUBLE OVEN RANGE						
Collection	Display Size	Oven Description	No of Functions	Colour	NEFF Home Connect	Model Code
N50	LCD Display	Double Ovens Pyrolytic	8/4	Graphite Grey	Yes	U2ACH7AG7B
N50	LCD Display	Double Ovens Pyrolytic	8/4	Stainless Steel	Yes	U2ACH7AN7B
N50	LCD Display	Double Ovens	5/4	Graphite Grey		U1ACE2AG3B
N50	LCD Display	Double Ovens	5/4	Stainless Steel		U1ACE2AN3B

N50 BUILT UNDER DOUBLE OVEN RANGE						
Collection	Display Size	Oven Description	No of Functions	Colour	NEFF Home Connect	Model Code
N50	LCD Display	Built under Double Ovens	6/4	Stainless Steel		J1ACE2HN0B

N50 DRAWER RANGE						
Collection	Drawer Range			Colour		Model Code
N50	29cm Warming Drawer			Stainless Steel		N1AHA02N0B
N50	14cm Warming Drawer			Graphite Grey		N1AHA01G0B
N50	14cm Warming Drawer			Stainless Steel		N1AHA01N0B

Optional Accessories for Ovens and Compacts

NEFF OPTIONAL ACCESSORIES	DESCRIPTION	SUITABLE FOR
SHELVES & INTERNAL RAILS		
Z11CR10X0	Full width wire shelf.	N90 & N70 single & compact ovens and N50 single ovens.
Z1608BX0	1 pair of level independent telescopic shelf rails with stop, fully extendible, for non-pyrolytic, non-full steam.	N70 & N90 ovens
Z1608CX0	1 pair of level independent telescopic shelf rails with stop, fully extendible.	N70 & N90 Pyrolytic ovens
Z1608DX0	1 pair of level independent telescopic shelf rails with stop, fully extendible.	N90 Steam ovens
Z1650BE0	2 piece, half depth enamel pan set.	N90 Steam ovens
Z11TI15X0	1 pair of level independent ClipRail telescopic rails.	N50 single and double ovens
AIR FRYER ACCESSORY - AIR FRY FUNCTION AVAILABLE AS A NEFF HOME CONNECT DOWNLOAD.		
Z1655CA0	Air Fryer & Grill tray.	Required for Air Fry Function, for NEFF ovens with NEFF Home Connect .
INTERMEDIATE PLATFORM		
Z166CAX0	Intermediate Floor for combining 2 ovens.	N90 & N70
SEAMLESS COMBINATION ACCESSORIES - GRAPHITE GREY		
Z11SZ60G0	Seamless Combination strips - 45cm Compact & 14cm Drawer. Graphite Grey	N90 & N70 Compact Ovens & 14cm Warming Drawer. NOT suitable for 45cm N90 Coffee machine or C24GR3XG1B - N70 Compact Microwave.
Z11SZ80G0	Seamless Combination strips - 60cm Slide & Hide® Single Oven & 29cm Warming Drawer - Graphite Grey	N90 & N70 60cm Slide&Hide single ovens and 29cm warming drawer.
Z11SZ90G0	Seamless Combination strips, metal platform and brackets for Slide & Hide® single oven and selected 45cm Compact ovens in column. Graphite Grey	N90 & N70 single oven and selected 45cm Compact (special single aperture required; not suited to Coffee Machine and C24GR3XG1B)
SEAMLESS COMBINATION ACCESSORIES - STAINLESS STEEL		
Z11SZ60X0	Seamless Combination strips - 45cm Compact & 14cm Drawer. Stainless Steel	N90 & N70 Compact Ovens & 14cm Warming Drawer. NOT suitable for 45cm N90 Coffee machine.
Z11SZ80X1	Seamless Combination strips - 60cm Slide & Hide® Single Oven & 29cm Warming Drawer - Stainless Steel	N90 & N70 60cm Slide&Hide single ovens and 29cm warming drawer.
Z11SZ90X0	Seamless Combination strips, metal platform and brackets for Slide & Hide® single oven and selected 45cm Compact ovens in column. Stainless Steel	N90 & N70 single oven and selected 45cm Compact (special single aperture required; not suited to Coffee Machine)
SEAMLESS COMBINATION ACCESSORIES -OTHER		
Z13CV06S0	Cosmetic decor strip for use between 60cm single and 45cm compact ovens	N90, N70, N50
MEATPROBE		
Z1365WX0	Multi Point Temperature Probe – can be used in the oven, on the hob & on the BBQ. Connect with NEFF NEFF Home Connect App.	For all temperature based cooking.

THE NEFF OVEN COLLECTIONS

HOBS

VENTILATION

REFRIGERATION

DISHWASHING

LAUNDRY

Open for FLEXIBILITY



Our first kitchen series that's as unique as you are.

At NEFF, we believe that openness is the key to everything creative. It's a mindset that we share with other open-minded and free-spirited hobby chefs and food lovers all around the world. People with an insatiable appetite for the extraordinary, and a constant craving for the unconventional – in and outside the kitchen. People that would always choose individuality over conformity.

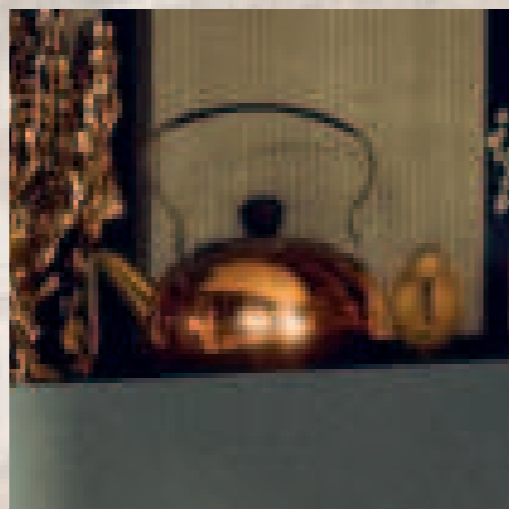

- 1 Seamlessly combine a Compact Oven and a Single Oven with our 105cm Seamless Combination trim.
- 2 The new NEFF Flex Design trim allows you to add the accent trim to the Angled Glass Chimney hood, extending the accent colour across the kitchen.
- 3 Introducing the Twist Pad Flex® to accent the colour on the Induction Hob control. On selected models the Twist Pad Flex® can also be used to control the oven.
- 4 The NEFF Flex trim can also be added as a side strip to the Induction Hob to further complement the range.

Open for PERSONALISED STYLE

Flex Trim finishes

It's details that make us special. Individual. Unmistakable. We believe your kitchen should be, too. That's why we've made it possible to personalise your appliances with the new NEFF Flex Design: interchangeable design elements such as handles and side trims in four distinctive colours for your oven, hood, hob, coffee machine and even your Twist Pad Flex®. Look forward to a Deep Black, Brushed Bronze, Metallic Silver or Anthracite Grey. And because kitchens grow and tastes change, the choice is also flexible. Simply swap out the design elements to suit your new style giving each appliance a lifetime of great taste.

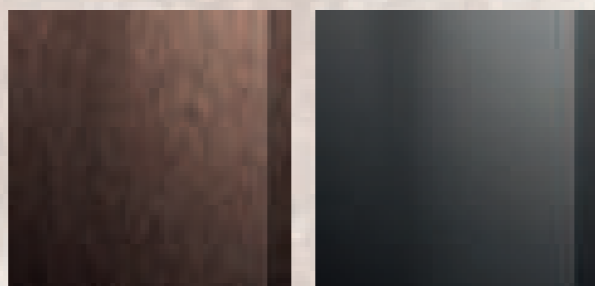

Brushed Bronze

Anthracite Grey

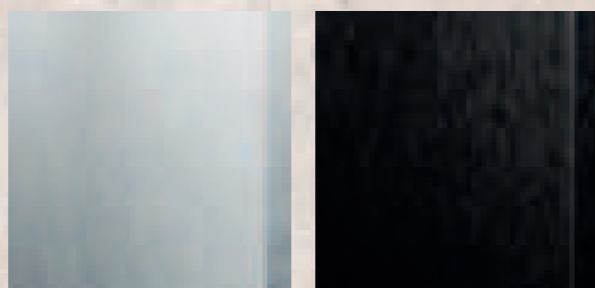

Metallic Silver

Deep Black

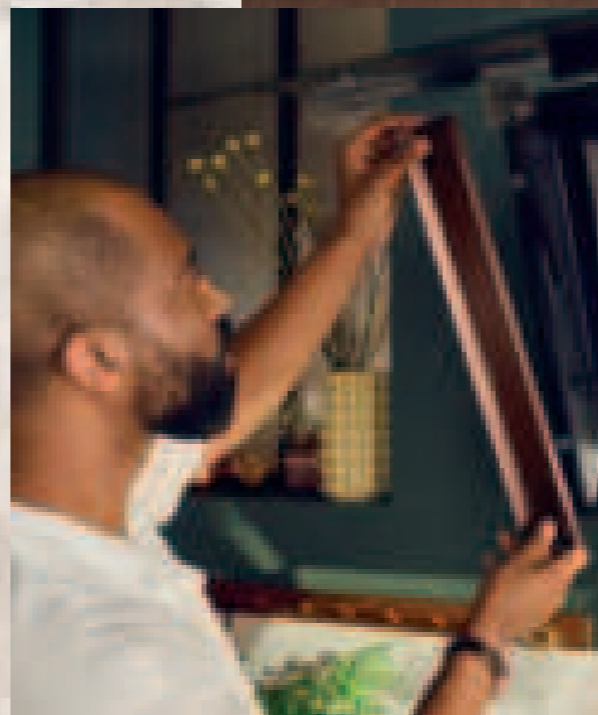

Easy to install

With Flex Design change is really easy: you can simply swap out design elements on your own, anytime you want to fit your new style.

Scan this code to view a video to see how to install and change the Flex Design trims.

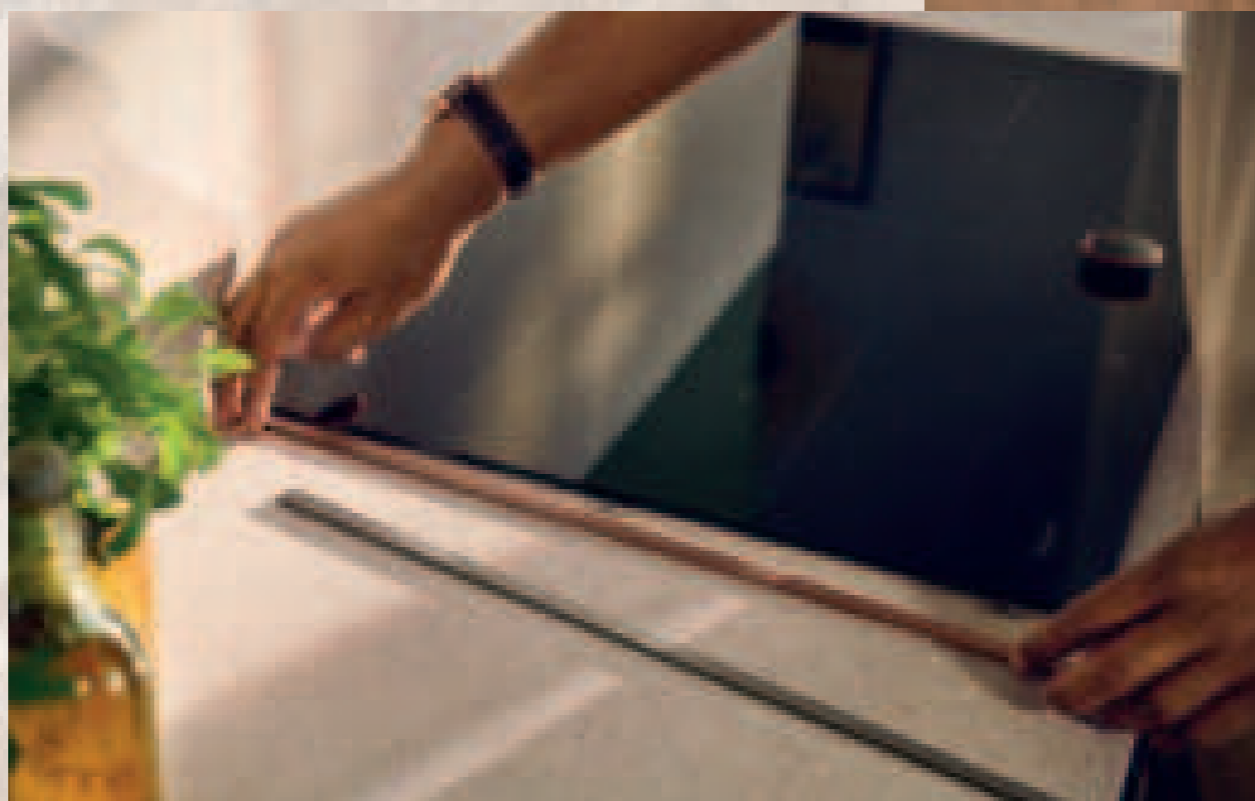
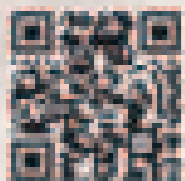

Throughout this brochure we have used the Brushed Bronze images – follow this link to our webpage to see the other colours brought to life online.

Flex Design Oven Range

For perfect alignment with your oven, horizontally or vertically, choose appliances from the same range – Flex Design or Core Range.

All single ovens have:

- Slide and Hide® with Soft Open / Close door and rotating handle*
- 1 pair Telescopic Rails
- Circo Therm®
- NEFF Home Connect











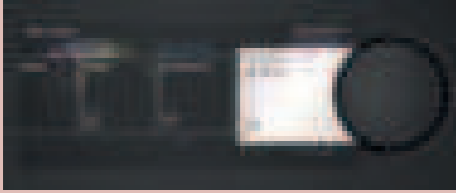

All compact ovens have:

- Soft Open / Close door
- 1 pair Telescopic Rails
- NEFF Home Connect

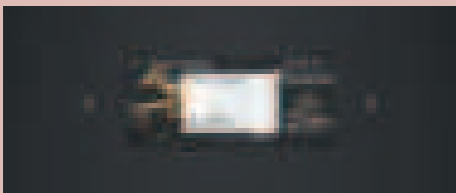

All microwaves have:

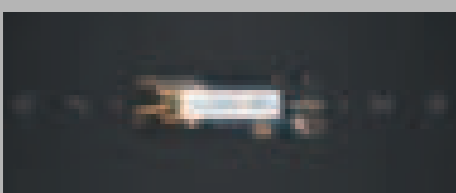
- Up to 900w
- 5 power levels

DISPLAY TYPE	SLIDE AND HIDE® SINGLE OVENS - WITH ROTATING HANDLE AND SOFT/OPEN CLOSE		
	WITH INTENSIVE STEAM	WITH VARIO STEAM®	
 <p>FULL TOUCH 3 - 6.8" FULL TOUCH TFT DISPLAY</p> <p>*Optional Twist Pad Flex® can be installed on Full Touch 3 only</p> <p>Airfry Function and Airfry Grid Tray available as a standard on all appliances.*</p>	 <p>B69FY5CX0</p> <ul style="list-style-type: none"> • 23 Functions • Multipoint Temperature Probe • Fixed water connection* • Code change to B69FY3CY2A September 2026 - water tank for steam 	 <p>B69VY7MY0</p> <ul style="list-style-type: none"> • 20 Functions • Vario Steam® via water tank • Pyrolytic • Multipoint Temperature Probe 	 <p>B69CY7MY0</p> <ul style="list-style-type: none"> • 14 Functions • Pyrolytic • Multipoint Temperature Probe
 <p>FULL TOUCH 2 - 4.1" FULL TOUCH TFT DISPLAY</p> <p>Airfry Function and Airfry Grid Tray available as a standard on all appliances.*</p> <p>Steam via water tank</p>	 <p>B69FS5CY0A</p> <ul style="list-style-type: none"> • 23 Functions • Intensive Steam* • Multipoint Temperature Probe *Change to cleaning system September 	 <p>B69VS7MY0A</p> <ul style="list-style-type: none"> • 21 Functions • Vario Steam® • Pyrolytic • Multipoint Temperature Probe 	 <p>B69CS7MY0B</p> <ul style="list-style-type: none"> • 14 Functions • Pyrolytic • Multipoint Temperature Probe
 <p>FULL TOUCH 1 - N70 3.7" FULL TOUCH TFT DISPLAY</p> <p>Airfry Function and Airfry Grid Tray available as a standard on all appliances.</p>			 <p>B59CR7KY0B</p> <ul style="list-style-type: none"> • 14 Functions • Pyrolytic <p>*Soft Open Door only</p>

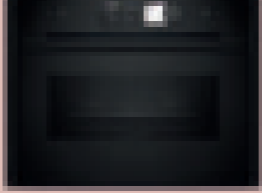
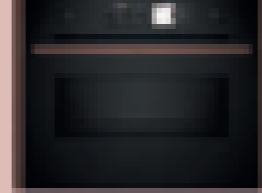
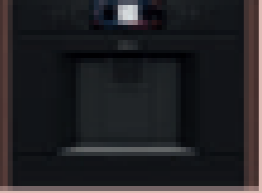
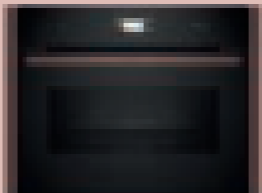
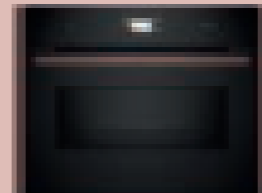
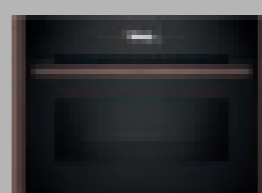
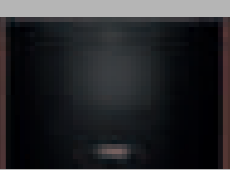
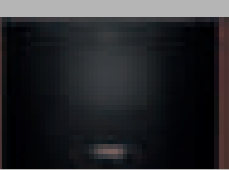
COMPACT OVENS		COFFEE MACHINE	MICROWAVES	
WITH STEAM	WITH MICROWAVE		LEFT HINGED DOOR	RIGHT HINGED DOOR
 <p>C29FY5CX0</p> <ul style="list-style-type: none"> • 23 Functions • Intensive Steam - with fixed water connection* • Code Change to C29FY5CX0 September 2026 - water tank for steam. • Multipoint Temperature Probe *Does not include Airfry Grid Tray 	 <p>C29MY7MY0</p> <ul style="list-style-type: none"> • 20 Functions • Multipoint Temperature Probe 	 <p>CL9TX11X0</p> <ul style="list-style-type: none"> • 11 Functions • Fixed water connection* • Code change to CL9TX11X0 where water will be via a tank. 		
 <p>C29FS3AY0</p> <ul style="list-style-type: none"> • 23 Functions • Intensive Steam *Does not include Airfry Grid Tray 	 <p>C29MS7KY0</p> <ul style="list-style-type: none"> • 20 Functions 			
	 <p>C29MR21Y0B</p> <ul style="list-style-type: none"> • 16 Functions <p>*Does not include Telescopic Rails</p>		 <p>NL9WR21Y1B</p> <ul style="list-style-type: none"> • Left Hinged Door • Up to 900w • 5 power levels 	 <p>NR9WR21Y1B</p> <ul style="list-style-type: none"> • Right Hinged Door • Up to 900w • 5 power levels

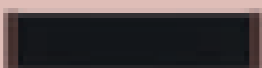
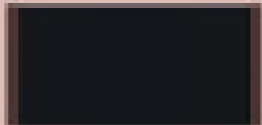
DISPLAY TYPE	14CM DRAWER	29CM DRAWER
	WARMING DRAWER	WARMING DRAWER
<p>All drawers have:</p> <ul style="list-style-type: none"> • Push / pull opening • 6 temperature settings 	 <p>N29HA11Y1B</p>	 <p>N39HA11Y1B</p>

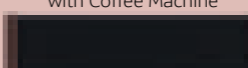
14CM DRAWER
WARMING DRAWER
<p>for seamless combination with Coffee Machine</p>  <p>N29HA11Y2</p>

Flex Design N90 Full Touch 3 Single & Compact Ovens

- Electronic, 6.8" Premium Full Touch TFT Display on all models
- All ovens feature Circo Therm®



60CM SLIDE & HIDE® SINGLE OVEN

	INTENSIVE STEAM* B69FY5CX0 N90	VARIO STEAM® / PYROLYTIC B69VY7MY0 N90	PYROLYTIC B69CY7MY0 N90
	<ul style="list-style-type: none"> • 23 functions, inc. Full Steam • Multi Point Temperature Probe • Rotating handle • Soft open/close door 	<ul style="list-style-type: none"> • 20 functions, inc. Vario Steam® • Multi Point Temperature Probe • Rotating handle • Soft open/close door 	<ul style="list-style-type: none"> • 14 functions • Multi Point Temperature Probe • Rotating handle • Soft open/close door
OPERATION	•	•	•
Option to Add Twist Pad Flex®	•	•	•
CONTROLS			
Electronic control	•	•	•
Temperature proposal with display	•/•	•/•	•/•
Heating up indicator/ Residual heat indicator	•/•	•/•	•/•
Control panel lock/ Safety switch off	•/•	•/•	•/•
Automatic programmes	•	•	•
NEFF Home Connect	•	•	•
SPECIAL FEATURES			
Door type	Slide & Hide® With Rotating Handle, Soft Close	Slide & Hide® With Rotating Handle, Soft Close	Slide & Hide® With Rotating Handle, Soft Close
Tap Water Connection(fixed)	•*	•	•
Soft open door	•	•	•
Oven Assistant with Voice Control	•	•	•
Telescopic Rail	1 x Clip Rail, Full Extn Stop Function	1 x Clip Rail, Full Extn Stop Function	1 x Clip Rail, Full Extn Stop Function
Multi Point Temperature Probe	•	•	•
Rapid heat up	•	•	•
Baking and roasting assistant	•	•	•
FEATURES			
Electronic clock / timer	White TFT Display	White TFT Display	White TFT Display
Full glass inner door	•	•	•
Glazed door (Quadruple/Triple/Double)	Triple (Cool Touch door)	Quadruple (Cool Touch door)	Quadruple (Cool Touch door)
Internal lighting	LED Light	LED Light	LED Light
Water tank empty indicator	•	•	•
COOKING FUNCTIONS	23	20	14
Intensive Steam (Full Steam)	•	•	•
Vario Steam®	•	•	•
Steam Boost	•	•	•
Keep Warm with Added Steam / Reheat with Added Steam	•/•	•	•
Airfry Function	•	•	•
Sous-vide cooking	•	•	•
Circo Therm® / Circo Therm® Gentle	•/•	•/•	•/•
Top heat / Top/bottom heat Gentle / Bottom heat	•/•/•	•/•/•	/ /•
Conventional heat/Conventional heat gentle	•	•	•
Low temperature cooking	•	•	•
Hot air grilling / Centre Surface Grill / Full surface grill	•/•/•	•/•/•	•/•/•
Circo Roasting	•	•	•
Bread Baking Function / Pizza setting	•/•	•/•	•/•
Defrost / Dough Proving	•/•	•/•	•/•
Keep Warm / Pre-heating / Plate warming	•/•/•	•/•/•	/•/•
Microwave Power Settings	W		
Microwave Cooking Programmes			
OVEN CLEANING			
Pyrolytic cleaning	•	•	•
Easy Clean / Base Clean	•	•	•
Eco Clean Surface	•	•	•
Cleaning setting	•	•	•
Descaling programme	•	•	•
STANDARD ACCESSORIES			
Combination Grid	1	1	1
Universal pan	1	1	1
Air-Fry Grid Tray	1	1	1
Steam Container	3		
Sponge	1		
Baking Tray	1	1	1
ENERGY EFFICIENCY:			
Energy efficiency class	A+	A+	A+
Energy consumption per cycle Circo Therm	kWh 0.69	kWh 0.69	kWh 0.69
Energy consumption per cycle conventional	kWh 0.87	kWh 0.87	kWh 0.87
Oven capacity	L 71	L 71	L 71
Time to cook standard load	mins 44	mins 44	mins 44
Largest baking sheet area	cm² 1290	cm² 1290	cm² 1290
Microwave Max Power	W		
Nominal Voltage	v		
Minimum fuse protection	Amps		
TECHNICAL INFORMATION			
Total connected load	kW 3.6	kW 3.6	kW 3.6

45CM COMPACT OVEN

	INTENSIVE STEAM* C29FY5CX0 N90	WITH MICROWAVE C29MY7MY0 N90
	<ul style="list-style-type: none"> • 23 functions, inc. Full Steam • Multi Point Temperature Probe • Rotating handle • Soft open/close door 	<ul style="list-style-type: none"> • 20 functions, inc. Pyrolytic • Multi Point Temperature Probe • Rotating handle • Soft open/close door
OPERATION	•	•
Option to Add Twist Pad Flex®	•	•
CONTROLS		
Electronic control	•	•
Temperature proposal with display	•/•	•/•
Heating up indicator/ Residual heat indicator	•/•	•/•
Control panel lock/ Safety switch off	•/•	•/•
Automatic programmes	•	•
NEFF Home Connect	•	•
SPECIAL FEATURES		
Door type	Drop Down Door, Soft Opening, Soft Closing	Drop Down Door, Soft Opening, Soft Closing
Tap Water Connection(fixed)	•*	•
Soft open door	•	•
Oven Assistant with Voice Control	•	•
Telescopic Rail	1 x Clip Rail, Full Extn Stop Function	1 x Clip Rail, Full Extn Stop Function
Multi Point Temperature Probe	•	•
Rapid heat up	•	•
Baking and roasting assistant	•	•
FEATURES		
Electronic clock / timer	White TFT Display	White TFT Display
Full glass inner door	•	•
Glazed door (Quadruple/Triple/Double)	Triple (Cool Touch door)	Quadruple (Cool Touch door)
Internal lighting	LED Light	LED Light
Water tank empty indicator	•	•
COOKING FUNCTIONS	23	20
Intensive Steam (Full Steam)	•	•
Vario Steam®	•	•
Steam Boost	•	•
Keep Warm with Added Steam / Reheat with Added Steam	•/•	•
Airfry Function	•	•
Sous-vide cooking	•	•
Circo Therm® / Circo Therm® Gentle	•/•	•/•
Top heat / Top/bottom heat Gentle / Bottom heat	•/•	•/•
Conventional heat/Conventional heat gentle	•	•
Low temperature cooking	•	•
Hot air grilling / Centre Surface Grill / Full surface grill	•/•/•	•/•/•
Circo Roasting	•	•
Bread Baking Function / Pizza setting	•/•	•/•
Defrost / Dough Proving	•/•	•/•
Keep Warm / Pre-heating / Plate warming	•/•/•	•/•/•
Microwave Power Settings	W	
Microwave Cooking Programmes		90, 180, 360, 600, boost
OVEN CLEANING		
Pyrolytic cleaning	•	•
Easy Clean / Base Clean	•	•
Eco Clean Surface	•	•
Cleaning setting	•	•
Descaling programme	•	•
STANDARD ACCESSORIES		
Combination Grid	1	2
Universal pan	1	1
Air-Fry Grid Tray	1	1
Steam Container	3	
Sponge	1	
Baking Tray	1	1
ENERGY EFFICIENCY:		
Energy efficiency class	A+	A+
Energy consumption per cycle Circo Therm	kWh 0.73	kWh 0.61
Energy consumption per cycle conventional	kWh 0.87	kWh 0.87
Oven capacity	L 71	L 71
Time to cook standard load	mins 44	mins 44
Largest baking sheet area	cm² 1290	cm² 1290
Microwave Max Power	W	900
Nominal Voltage	v	220-240
Minimum fuse protection	Amps	16
TECHNICAL INFORMATION		
Total connected load	kW 3.3	kW 3.6

45CM COFFEE CENTRE

	FULLY AUTO* CL9TX11X0 / N90
	<ul style="list-style-type: none"> • Multiple international coffee variations • Strength and aroma management • Left hinged door
OPERATION	•
Option to Add Twist Pad Flex®	•
CONTROLS	
Electronic control	•
Water level indicator	•
Descaling indicator	•
Automatic Programmes	•
Child Safety	•
Child Lock	•
NEFF Home Connect	•
FEATURES	
Left-hand Door Hinge	•*
Tap water connection	•
Automatic milk amount detection	•
Height adjustable beverage outlet (max 15cm)	•
One Touch Double Cup	•
Illuminated coffee outlet, stage and interior	•
Water Pump (19 bar pressure)	•
Ceram Drive	•
6 adjustable grinding degree settings (multi-level)	•
30 min Auto-standby	•
FLAVOUR FEATURES	
Up to 29 Coffee Specialties	•
Coffee Pot Function	•
Aroma Select	•
Warm milk	•
Milk froth	•
Hot water function	•
Adjustable milk ratio	•
Intelligent strength adjustment	•
Aroma Double Shot	•
CLEANING	
Auto Milk Clean	•
Calc & Clean	•
Removable Brewing Unit	•
Dishwasher Proof (beverage outlet, drip tray/pans)	•
Automatic reminder	•
ACCESSORIES	
Test strip	•
Cleaning Tablets	•
Descaling Tablets	•
BRITA Intenza Water Filter	•
Care set	•
ENERGY EFFICIENCY	
Nominal Voltage	V 220-240
Total connected load	kW 1.5
Mains Frequency	Hz 50 / 60
TECHNICAL INFORMATION	
Appliance Dimensions HxWxD	mm 455x594x385
Mounted Dimensions HxWxD	mm 449x558x376
Removable water tank	L 2.4
Integrated milk container	L 0.7
Bean container with aroma protection lid	g 500
Cable length	cm 170

*These model features will all be changed from fixed water supply to water tanks from September 2026 & from Eco Clean to New Intensive Steam cleaning process.

Code Changes:
 B69FY5CX0 to B69FY32CY2A
 C29FY5CX0 to C29FY3CY2
 CI9TX11X0 to CL9TX11Y0

Flex Design N90 Full Touch 2 Single & Compact Ovens

- Electronic, 4.1" Full Touch TFT Display on all models
- All ovens feature Circo Therm®



Home Connect

60CM SLIDE & HIDE® SINGLE OVEN

INTENSIVE STEAM B69FS5CY0A* N90	VARIO STEAM® / PYROLYTIC B69VS7MY0A N90	PYROLYTIC B69CS7MY0B N90
<ul style="list-style-type: none"> • 23 functions, inc. Full Steam • Rotating handle • Soft open/close door 	<ul style="list-style-type: none"> • 21 functions, inc. Vario Steam® • Rotating handle • Soft open/close door 	<ul style="list-style-type: none"> • 14 functions • Rotating handle • Soft open/close door

CONTROLS			
Electronic control	●	●	●
Temperature proposal with display	●/●	●/●	●/●
Heating up indicator/ Residual heat indicator	●/●	●/●	●/●
Control panel lock/ Safety switch off	●/●	●/●	●/●
Automatic programmes	●	●	●
NEFF Home Connect	●	●	●
SPECIAL FEATURES			
Door type	Slide & Hide® With Rotating Handle, Soft Close	Slide & Hide® With Rotating Handle, Soft Close	Slide & Hide® With Rotating Handle, Soft Close
Tap Water Connection(fixed)			
Soft open door	●	●	●
Oven Assistant with Voice Control	●	●	●
Telescopic Rail	1 x Clip Rail, Full Extn Stop Function	1 x Clip Rail, Full Extn Stop Function	1 x Clip Rail, Full Extn Stop Function
Multi Point Temperature Probe	●	●	●
Rapid heat up	●	●	●
Baking and roasting assistant	●	●	●
FEATURES			
Electronic clock / timer	White TFT Display	White TFT Display	White TFT Display
Full glass inner door	●	●	●
Glazed door (Quadruple/Triple/Double)	Triple (Cool Touch door)	Quadruple (Cool Touch door)	Quadruple (Cool Touch door)
Internal lighting	LED Light	LED Light	LED Light
Water tank empty indicator	●	●	●
COOKING FUNCTIONS			
Intensive Steam (Full Steam)	23	21	14
Intensive Steam	●	●	●
Vario Steam®	●	●	●
Steam Boost	●	●	●
Keep Warm with Added Steam / Reheat with Added Steam	●/●	●/	●
Airfry Function	●	●	●
Sous-vide cooking	●	●	●
Circo Therm® / Circo Therm® Gentle	●/●	●/●	●/●
Top/bottom heat Gentle / Bottom heat	●/●/●	●/●/●	/ / ●
Conventional heat/Conventional heat gentle	●	●	●
Low temperature cooking	●	●	●
Hot air grilling / Centre Surface Grill / Full surface grill	●/●/●	●/●/●	●/●/●
Circo Roasting	●	●	●
Bread Baking Function / Pizza setting	●/●	●/●	●/●
Defrost / Dough Proving	●/●	●/●	/●
Keep Warm / Pre-heating / Plate warming	●/●/●	●/●/●	●/●/●
Microwave Power Settings	W		
Microwave Cooking Programmes			
OVEN CLEANING			
Pyrolytic cleaning		●	●
Easy Clean / Base Clean	●	●	●
Eco Clean Surface	●	●	●
Cleaning setting	●	●	●
Descaling programme	●	●	●
STANDARD ACCESSORIES			
Combination Grid	1	2	2
Universal pan	1	1	1
Air-Fry Grid Tray	1	1	1
Steam Container	3		
Sponge	1		
Baking Tray			
ENERGY EFFICIENCY:			
Energy efficiency class	A+	A+	A+
Energy consumption per cycle Circo Therm	kWh 0.69	kWh 0.69	kWh 0.69
Energy consumption per cycle conventional	kWh 0.87	kWh 0.87	kWh 0.87
Oven capacity	L 71	L 71	L 71
Time to cook standard load	mins 44	mins 44	mins 44
Largest baking sheet area	cm² 1290	cm² 1290	cm² 1290
Microwave Max Power	W		
Nominal Voltage	v		
Minimum fuse protection	Amps		
TECHNICAL INFORMATION			
Total connected load	kW 3.6	kW 3.6	kW 3.6

45CM COMPACT OVEN

INTENSIVE STEAM C29FS3AY0 N90	WITH MICROWAVE C29MS7KY0 N90
<ul style="list-style-type: none"> • 23 functions, inc. Full Steam • Soft open/close door 	<ul style="list-style-type: none"> • 20 functions, inc. Pyrolytic • Soft open/close door

CONTROLS		
Electronic control	●	●
Temperature proposal with display	●/●	●/●
Heating up indicator/ Residual heat indicator	●/●	●/●
Control panel lock/ Safety switch off	●/●	●/●
Automatic programmes	●	●
NEFF Home Connect	●	●
SPECIAL FEATURES		
Door type	Drop Down Door, Soft Opening, Soft Closing	Drop Down Door, Soft Opening, Soft Closing
Tap Water Connection(fixed)		
Soft open door	●	●
Oven Assistant with Voice Control	●	●
Telescopic Rail	1 x Clip Rail, Full Extn Stop Function	1 x Clip Rail, Full Extn Stop Function
Multi Point Temperature Probe	●	●
Rapid heat up	●	●
Baking and roasting assistant	●	●
FEATURES		
Electronic clock / timer	White TFT Display	White TFT Display
Full glass inner door	●	●
Glazed door (Quadruple/Triple/Double)	Quadruple (Cool Touch door)	Quadruple (Cool Touch door)
Internal lighting	LED Light	LED Light
Water tank empty indicator	●	●
COOKING FUNCTIONS		
Intensive Steam (Full Steam)	23	20
Intensive Steam	●	●
Vario Steam®	●	●
Steam Boost	●	●
Keep Warm with Added Steam / Reheat with Added Steam	●/●	●/
Airfry Function	●	●
Sous-vide cooking	●	●
Circo Therm® / Circo Therm® Gentle	●/●	●/●
Top/bottom heat Gentle / Bottom heat	●/●/●	●/●/●
Conventional heat/Conventional heat gentle	●	●
Low temperature cooking	●	●
Hot air grilling / Centre Surface Grill / Full surface grill	●/●/●	●/●/●
Circo Roasting	●	●
Bread Baking Function / Pizza setting	●/●	●/●
Defrost / Dough Proving	●/●	/●
Keep Warm / Pre-heating / Plate warming	●/●/●	●/●/●
Microwave Power Settings	W	
Microwave Cooking Programmes		90, 180, 360, 600, boost
OVEN CLEANING		
Pyrolytic cleaning		●
Easy Clean / Base Clean	●	●
Eco Clean Surface	●	●
Cleaning setting	●	●
Descaling programme	●	●
STANDARD ACCESSORIES		
Combination Grid	1	1
Universal pan	1	1
Air-Fry Grid Tray	1	1
Steam Container	3	
Sponge	1	
Baking Tray		
ENERGY EFFICIENCY:		
Energy efficiency class	A+	A+
Energy consumption per cycle Circo Therm	kWh 0.73	kWh 0.73
Energy consumption per cycle conventional	kWh 0.61	kWh 0.61
Oven capacity	L 71	L 71
Time to cook standard load	mins 44	mins 44
Largest baking sheet area	cm² 1290	cm² 1290
Microwave Max Power	W	900
Nominal Voltage	v	220-240
Minimum fuse protection	Amps	16
TECHNICAL INFORMATION		
Total connected load	kW 3.3	kW 3.6

* Code Change B69FS3CY2A September 2026
* Change will be from Eco Clean to new Intensive Steam Clean

1 Measured according to the EN50304, 65/2014. 2 For further information on inverter technology, please go to www.neffhome.com/uk. 3 For Inverter models, the maximum setting offers a time limited boost option for heating liquids. To ensure optimal results and to protect the appliance, the microwave power output is reduced in stages over the first few minutes down to the next power level (600W). After a cooling period, the microwave boost option will be available once more.

Flex Design N70 Full Touch 1 Single Oven, Compact Oven & Microwaves

- Electronic, 3.7" Full Touch TFT Display on all models
- All ovens feature Circo Therm®



	60CM SLIDE & HIDE® SINGLE OVEN	45CM COMPACT OVEN	38CM MICROWAVE	
	PYROLYTIC B59CR7KY0B N70	WITH MICROWAVE C29MR21Y0B N70	WITHOUT GRILL/LEFT OPENING NL9WR21Y1B N70	WITHOUT GRILL/RIGHT OPENING NR9WR21Y1B N70
	• 14 functions	• 16 functions	• MW only, up to 900W MW output, 21L	• MW only, up to 900W MW output, 21L
	• Rotating handle • Soft open door	• Soft open/close door	• Left hinged door	• Right hinged door
CONTROLS				
Electronic control	•	•	•	•
Temperature proposal with display	•/•	•/•	•	•
Heating up indicator/ Residual heat indicator	•/•	•/•		
Control panel lock/ Safety switch off	•/•	•/•		
Automatic programmes	•	•	•	•
NEFF Home Connect	•	•		
SPECIAL FEATURES				
Door type	Slide & Hide® With Rotating Handle, Soft Open	Drop Down Door, Soft Opening, Soft Closing	Left hinged door	Right hinged door
Soft open door	•	•		
Oven Assistant with Voice Control	•	•		
Telescopic Rail	1 x Clip Rail, Full Extn Stop Function	1 x Clip Rail, Full Extn Stop Function		
Multi Point Temperature Probe				
Rapid heat up	•	•	•	•
Baking and roasting assistant	•			
FEATURES				
Electronic clock / timer	White TFT Display	White TFT Display	TFT Display	TFT Display
Full glass inner door	•	•	•	•
Glazed door (Quadruple/Triple/Double)	Quadruple (Cool Touch door)	Triple (Cool Touch door)	Double	Double
Internal lighting	LED Light	LED Light	LED Light	LED Light
Water tank empty indicator				
COOKING FUNCTIONS	14	16	1 heating mode	1 heating mode
Intensive Steam (Full Steam)				
Vario Steam®				
Steam Boost				
Keep Warm with Added Steam / Reheat with Added Steam				
Airfry Function	•	•		
Sous-vide cooking				
Circo Therm® / Circo Therm® Gentle	•/•	•/•		
Top heat / Top/bottom heat Gentle / Bottom heat	/ /•	•/•		
Conventional heat/Conventional heat gentle	•	•		
Low temperature cooking	•	•		
Hot air grilling / Centre Surface Grill / Full surface grill	•/•/•	•/•/•		
Circo Roasting	•	•		
Bread Baking Function / Pizza setting	•/•	•/•		
Defrost / Dough Proving	/•	/•	x3/	x3/
Keep Warm / Pre-heating / Plate warming	•/•/•	•/•/•		
Microwave Power Settings	W	90, 180, 360, 600, boost	90, 180, 360, 600, boost	90, 180, 360, 600, boost
Microwave Cooking Programmes		•	x3 Defrost, x4 Cooking	x3 Defrost, x4 Cooking
OVEN CLEANING				
Pyrolytic cleaning	•			
Easy Clean / Base Clean	•	•	•	•
Eco Clean Surface				
Cleaning setting	•	•	•	•
Descaling programme				
STANDARD ACCESSORIES				
Combination Grid	2	1		
Universal pan	1	1		
Airfry Grid Tray	1	1		
ENERGY EFFICIENCY:				
Energy efficiency class	A+			
Energy consumption per cycle Circo Therm kWh	0.69			
Energy consumption per cycle conventional kWh	0.87			
Oven capacity	L	71		
Time to cook standard load	mins	44		
Largest baking sheet area	cm²	1290		
Microwave Max Power	W	900	900	900
Nominal Voltage	v	220-240	220-240	220-240
Minimum fuse protection	Amps	16	10	10
TECHNICAL INFORMATION				
Total connected load	kW	3.6	1.22	1.22

Flex Design Warming Drawers & Accessory



	29CM WARMING DRAWER	14CM WARMING DRAWER	14CM COFFEE WARMING DRAWER
	N39HA11Y1B N90 / N70	N29HA11Y1B N90 / N70	N29HA11Y2 N90 / N70
	• 29cm high • Electronic touch control warming drawer • 4 settings or 6 selectable temperature settings • Timer • Heated ceramic base • Push/pull opening	• 14cm high • Electronic touch control warming drawer • 4 settings or 6 selectable temperature settings • Timer • Heated ceramic base • Push/pull opening	• 14cm high • Electronic touch control warming drawer • 4 settings or 6 selectable temperature settings • Timer • Heated ceramic base • Push/pull opening • This warming drawer is required when installing the coffee machine seamlessly • ZC060TY0 – Accessory for installation is also required
CONTROLS			
Electronic control	•	•	•
FUNCTIONS			
Plate warming	•	•	•
Hold Warm	•	•	•
Defrost	•	•	•
Low temperature cooking	•	•	•
FEATURES			
Operating indicator light	•	•	•
Electronic control	•	•	•
Rotary temperature control dial			
Touch control	•	•	•
Number of temperature settings	4	4	4
Number of vacuum seal time settings			
Number of vacuum sealing levels - bags / containers			
Glass safety lid			
Maximum temperature	80	80	80
Minimum temperature	30	30	30
Ceramic Glass Base	•	•	•
DESIGN			
Install independently	•	•	•
Install with compact appliance	N70 / N90	N70 / N90	N70 / N90
Install with a single oven	N70 / N90	N70 / N90	N70 / N90
Push-Pull opening mechanism	•	•	•
TECHNICAL INFORMATION			
Drawer interior volume	L	54	20
Interior drawer dimensions HxWxD	mm	290x594x518mm	140x594x518
Cavity Volume	L		20
Installation in tall housing or under work surface	•	•	•
Maximum weight capacity	25	25	25
Total connected loading	kW	0.82	0.82
Minimum fuse rating	A	10	10
Cable length	cm	175	170
GB plug	•	•	•
STANDARD ACCESSORIES			
Vacuuuming platform			
External vacuuuming adaptor, hose & plugs			
Sample vacuuuming bags			
Antislip mat			

1 Measured according to the EN50304, 65/2014. 2 For further information on inverter technology, please go to www.neffhome.com/uk. 3 For Inverter models, the maximum setting offers a time limited boost option for heating liquids. To ensure optimal results and to protect the appliance, the microwave power output is reduced in stages over the first few minutes down to the next power level (600W). After a cooling period, the microwave boost option will be available once more.

How to order with FLEX DESIGN

Our introduction to Flex Design within the NEFF Collection has tried to inspire you with all the possibilities that this new NEFF Collection brings you.

The ability to customise appliances to your customers' needs while offering all the fantastic features and functions that NEFF delivers. The following chapters focus on the detail of how exactly you go about ordering and installing these appliances.



Customise to your style

Customising your appliance to match your kitchen is a concept that allows you to match oven trims and selected surface cooking and hoods to match the colours in the kitchen. Every appliance detailed in the next section is available in all four Flex Design trims.



Brushed Bronze

Anthracite Grey

Metallic Silver

Deep Black

Perfect alignment

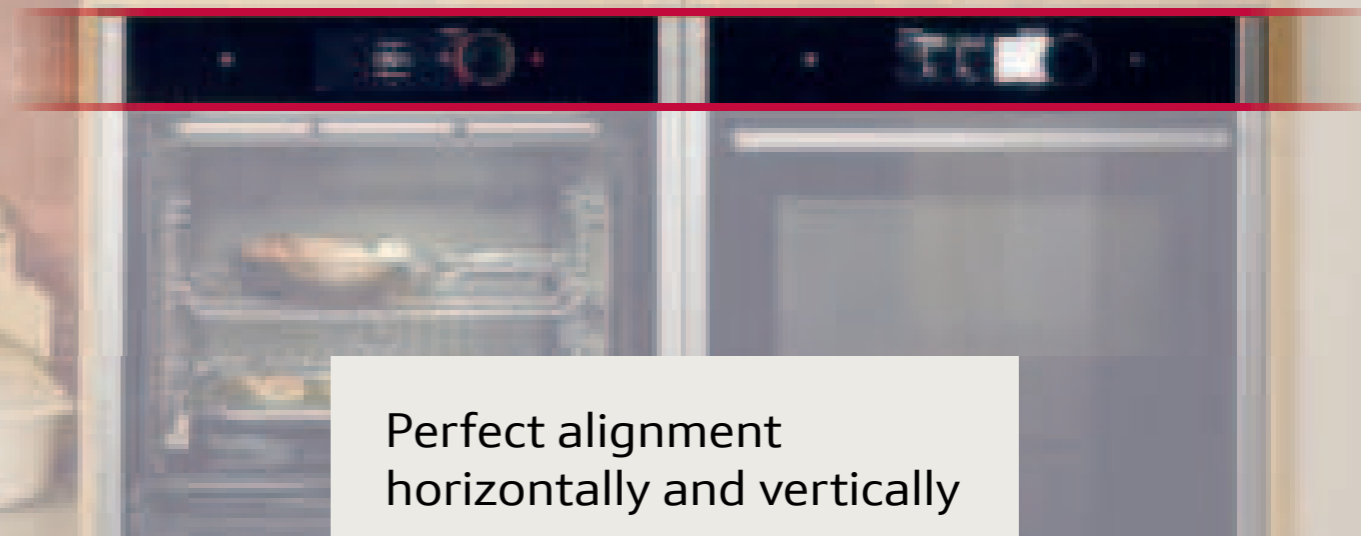

Perfect alignment horizontally and vertically

The range has been considered to give perfect alignment across the value classes and all configurations are available in every colour.



Single appliance



Seamless Combination

Step-by-step approach to ordering

Whether you are ordering a single appliance or a suite of appliances to seamlessly combine vertically and horizontally, the following section will guide you through the process.

- If ordering single appliances, our step-by-step guide details the ordering process.
- If ordering multiple appliances to combine seamlessly, this process is also detailed.
- The guide navigates you, in a clear way, through the model codes to include when ordering.
- At the end of the seamless combination section we have included furniture installation guides.
- Further details on installation and colours can be seen by scanning our QR code where we will host videos online.



To make the ordering of the Flex Design range easy, this page shows the stages in ordering a single appliance or a suite of appliances to install seamlessly. The follow pages are an extensive guide with codes and installation apertures for furniture.

The way the concept works – single appliance

Our Flex Design concept is designed to build the appliance to the individual design requirement. The appliance is “blank” – choose the appliance you want to specify and then add the Flex Design trims in the chosen colour to create the final product. The Flex Design trim includes the handle and the side trim to the personalised colour required.

Follow the three easy steps below to configure your desired single appliance. ¹

Flex Design Trim is available in four distinctive colours.



	STEP 1 CHOOSE YOUR APPLIANCE	STEP 2 CHOOSE YOUR FLEX DESIGN TRIM	STEP 3 YOUR COMPLETE SET READY TO INSTALL
N90 FULL TOUCH 3 – 6.8" DISPLAY APPLIANCES	<p>Full Touch 3 appliance operates as a Full Touch interface. An optional one or two Twist Pad Flex® can be added to enable dial control. See page 17 for more details.</p> <p>Blank Appliance Model Number: B69VY7MY0</p>	<p>Flex Design Trim Model Numbers: Z9060BY0 + Z9801TWBY0 Twist Pad Flex®</p>	<p>Complete Appliance Model Numbers: B69VY7MY0 + Z9060BY0 + Z9801TWBY0</p>
N90 FULL TOUCH 2 – 4.1" DISPLAY AND N70 FULL TOUCH 1 – 3.7" DISPLAY APPLIANCES	<p>Blank Appliance Model Number: B69FS5CY0A</p>	<p>Flex Design Trim Model Number: Z9060BY0</p>	<p>Complete Appliance Model Numbers: B69FS5CY0A + Z9060BY0</p>

¹ Twist Pad Flex® is an additional accessory for N90 Full Touch 3 display appliances only.

The way the concept works – combining multiple appliances

Consideration has been made when installing the appliances seamlessly and the NEFF Collection Range of Flex Design appliances allows for more freedom when combining appliances. In the same way as choosing a single appliance, when you want to combine them the process is the same but you need to find the right installation trim that matches your combination (see variations on pages 76-77).

Configure your desired seamless combination following the three easy steps below. Some combinations require additional installation accessories fully detailed in this section.

	STEP 1 CHOOSE YOUR APPLIANCES AND INSTALLATION COMBINATION	STEP 2 CHOOSE FLEX TRIM AND ACCESSORIES	STEP 3 YOUR COMPLETE SET READY TO INSTALL
N90 FULL TOUCH 3 – 6.8" DISPLAY APPLIANCES	<p>Blank Appliances Model Numbers: B69FY5CX0 + C29MY7MY0 + N29HA11Y1B</p>	<p>Flex Design Trim Model Numbers: 2 x Z9801TWBY0 Twist Pad Flex® + Z912BBY0 + *Z166CAX0 ²</p>	<p>Complete Appliance Model Numbers: B69FY5CX0 + C29MY7MY0 + N29HA11Y1B + 2 x Z9801TWBY0 + Z912BBY0 + *Z166CAX0 ²</p>
N90 FULL TOUCH 2 – 4.1" DISPLAY AND N70 FULL TOUCH 1 – 3.7" DISPLAY APPLIANCES	<p>Blank Appliances Model Numbers: B69FS5CY0A + C29FS3AY0 + N29HA11Y1B</p>	<p>Flex Design Trim Model Numbers: Z912BBY0 + *Z166CAX0 ²</p>	<p>Complete Appliance Model Numbers: B69FS5CY0A + C29FS3AY0 + N29HA11Y1B + Z912BBY0 + *Z166CAX0 ²</p>

¹ Appliance examples shown with Brushed Bronze Flex Design Trim.

² The Intermediate platform is required when installing an oven on top of another oven and is a Required Accessory.

The seamless combination FAMILY

The NEFF Flex Design range is not only available in four distinctive colours but the new seamless combination strips are available in seven lengths to allow for the ultimate in personalised installation solutions. Perfect when curating solutions, with a beautiful design aesthetic. These sizes allow for new combinations: stack a compact and a microwave, a single oven and a small warming drawer, or even two single ovens in a tall bank – the flexibility on installations has so many more possibilities.

There are 7 stackable sizes and within each you can have a variety of combinations to suit your cooking style.

60cm

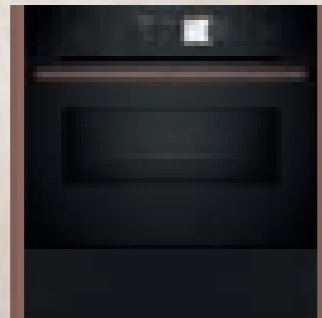

75cm

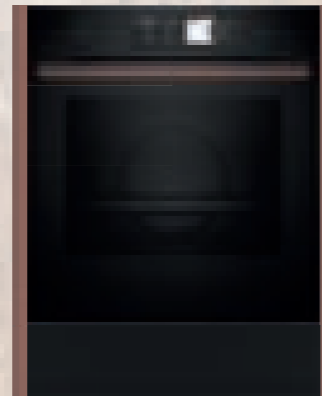

88cm

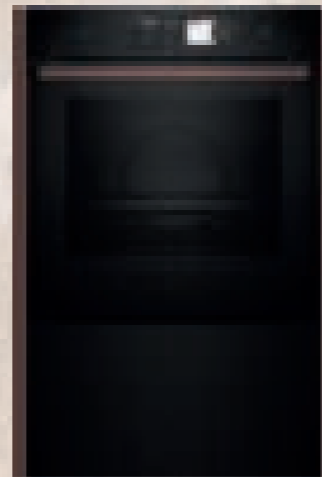

90cm



98cm



105cm



120cm



Your guide to ordering a Single Appliance with Flex Design

Single Ovens

Flex Design pack includes Single Oven Side Trims and Handle for 60cm NEFF Collection Flex Design Oven.

STEP 1 CHOOSE YOUR SINGLE OVEN				STEP 2 CHOOSE YOUR FLEX DESIGN TRIM		STEP 3 COMPLETED APPLIANCE
Collection	Display Size	Oven Type	Model Number	Finish	Model Number	
N90	Full Touch 3	Slide and Hide® Single Pyrolytic Oven with Vario Steam®	B69VY7MY0	Anthracite Grey	Z9060AY0	
N90	Full Touch 3	Slide and Hide® Single Pyrolytic Oven	B69CY7MY0			
N90	Full Touch 3	Slide and Hide® Single Oven with Intensive Steam	B69FY5CX0	Brushed Bronze	Z9060BY0	
N90	Full Touch 2	Slide and Hide® Single Pyrolytic Oven with Vario Steam®	B69VS7MY0A			
N90	Full Touch 2	Slide and Hide® Single Pyrolytic Oven	B69CS7MY0B	Deep Black	Z9060DY0	
N90	Full Touch 2	Slide and Hide® Single Oven with Intensive Steam	B69FS5CY0A			
N90	Full Touch 2	Slide and Hide® Single Oven with Intensive Steam	B69FS5CY0A	Metallic Silver	Z9060MY0	
N70	Full Touch 1	Slide and Hide® Single Pyrolytic Oven	B59CR7KY0B			

Model shown:
B69VY7MY0 Single Oven
Z9060BY0 Flex Design Trim

Compact Ovens

Flex Design pack includes Compact Oven Side Trim and Handle for 45cm NEFF Collection Flex Design Oven.

STEP 1 CHOOSE YOUR COMPACT OVEN				STEP 2 CHOOSE YOUR FLEX DESIGN TRIM		STEP 3 COMPLETED APPLIANCE
Collection	Display Size	Oven Type	Model Number	Finish	Model Number	
N90	Full Touch 3	Compact Oven with Intensive Steam	C29FY5CX0	Anthracite Grey	Z9045AY0	
N90	Full Touch 3	Compact Oven with Microwave	C29MY7MY0			
N90	Full Touch 2	Compact Oven with Intensive Steam	C29FS3AY0	Brushed Bronze	Z9045BY0	
N90	Full Touch 2	Compact Oven with Microwave	C29MS7KY0			
N90	Full Touch 2	Compact Oven with Microwave	C29MS7KY0	Deep Black	Z9045DY0	
N70	Full Touch 1	Compact Oven with Microwave	C29MR21Y0B			

Model shown:
C29FY5CX0 Compact Oven
Z9060BY0 Flex Design Trim

Microwaves

Flex Design pack includes 38cm Microwaves Side Trim for NEFF Collection Flex Design Microwave.

STEP 1 CHOOSE YOUR MICROWAVE OVEN				STEP 2 CHOOSE YOUR FLEX DESIGN TRIM		STEP 3 COMPLETED APPLIANCE
Collection	Display Size	Oven Type	Model Number	Finish	Model Number	
N70	Full Touch 1	38cm Microwave Oven - Left Hinged Door	NL9WR21Y1B	Anthracite Grey	Z9038AY0	
				Brushed Bronze	Z9038BY0	
N70	Full Touch 1	38cm Microwave Oven - Right Hinged Door	NR9WR21Y1B	Deep Black	Z9038DY0	
				Metallic Silver	Z9038MY0	

Model shown:
NL9WR21Y1B Microwave
Z9038DY0 Flex Design Trim

Coffee Machine

Flex Design pack includes Coffee Machine Side Trims for NEFF Collection Flex Design Coffee Machine.

STEP 1 CHOOSE YOUR COFFEE MACHINE				STEP 2 CHOOSE YOUR FLEX DESIGN TRIM		STEP 3 COMPLETED APPLIANCE
Collection	Display Size	Coffee Machine Type	Model Number	Finish	Model Number	
N90	Full Touch 3	Compact Coffee Machine - Left Hinged Door	CL9TX11X0	Anthracite Grey	ZC045AY0	
				Brushed Bronze	ZC045BY0	
				Deep Black	ZC045DY0	
				Metallic Silver	ZC045MY0	

Model shown:
CL9TX11X0 Coffee Machine
ZC045BY0 Flex Design Trim

14cm Warming Drawer

Flex Design pack includes 14cm Side Trims for NEFF Collection 14cm Drawers.

STEP 1 CHOOSE YOUR DRAWER			STEP 2 CHOOSE YOUR FLEX DESIGN TRIM		STEP 3 COMPLETED APPLIANCE
Collection	Drawer Type	Model Number	Finish	Model Number	
N90/70	14cm Warming Drawer	N29HA11Y1B	Anthracite Grey	Z9014AY0	
			Brushed Bronze	Z9014BY0	
			Deep Black	Z9014DY0	
			Metallic Silver	Z9014MY0	

Model shown:
N29HA11Y1B 14cm Drawer
Z9014BY0 Flex Design Trim

29cm Warming Drawer

Flex Design pack includes 29cm Side Trims for NEFF Collection 29cm Drawer.

STEP 1 CHOOSE YOUR DRAWER			STEP 2 CHOOSE YOUR FLEX DESIGN TRIM		STEP 3 COMPLETED APPLIANCE
Collection	Drawer Type	Model Number	Finish	Model Number	
N90/70	29cm Warming Drawer	N39HA11Y1B	Anthracite Grey	Z9029AY0	
			Brushed Bronze	Z9029BY0	
			Deep Black	Z9029DY0	
			Metallic Silver	Z9029MY0	

Model shown:
N39HA11Y1B 29cm Drawer
Z9029BY0 Flex Design Trim

i Twist Pad Flex® is an additional accessory for N90 Full Touch 3 display appliances only.

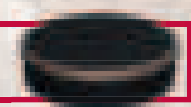

Your Guide To Cooking Seamless Combination Flex Design

The Flex Design range of Seamless Combination strips means there are many more ways to combine appliances. There are 7 strips and for some of the strips there are several combinations available. This following section includes the detail required to install every combination available.

Once a combination has been decided with the customer, this guide will navigate you through the aperture that this size will fit (line drawings and installation follow this section). For each combination we have included the guide to ordering.

Once you have decided what to combine and the installation you would like - find the illustrated example and choose the appliances - detailed alongside the illustration. Then choose the Flex Design trim in the chosen colour - each trim is configured with the correct amount of side trims and handles.

When the installation involves stacking an oven on another oven or compact oven, you require an intermediate shelf - code supplied. Finally if on selected Full Touch 3 models you want to add an optional Twist Pad Flex® then the codes are available.



60cm Trim – Compact Oven and Drawer

45cm Compact oven installed with a 14cm drawer

STEP 1 CHOOSE YOUR COMPLETED COMBINATION

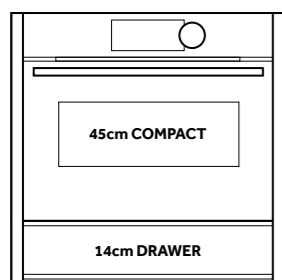

STEP 2 SUITABLE APPLIANCES

CHOOSE YOUR COMPACT OVEN

Collection	Display Size	Compact Oven Type	Model Number
N90	Full Touch 3 Display	Compact Oven with Intensive Steam	C29FY5CX0
N90	Full Touch 3 Display	Compact Oven with Microwave	C29MY7MY0
N90	Full Touch 2 Display	Compact Oven with Intensive Steam	C29FS3AY0
N90	Full Touch 2 Display	Compact Oven with Microwave	C29MS7KY0
N70	Full Touch 1 Display	Compact Oven with Microwave	C29MR21Y0B

CHOOSE YOUR DRAWER

Collection	Drawer Type	Model Number
N90 / N70	14cm Warming Drawer	N29HA11Y1B

STEP 3 CHOOSE YOUR FLEX DESIGN TRIM. TRIM INCLUDES 2 X 60CM SIDE TRIMS AND 1 HANDLE

Finish	Model Number
Anthracite Grey	Z9060AY0
Brushed Bronze	Z9060BY0
Deep Black	Z9060DY0
Metallic Silver	Z9060MY0

OPTIONAL ACCESSORY

Twist Pad Flex® is an additional accessory for Full Touch 3 appliances.

Finish	Model Number
Anthracite Grey	Z9801TWAY0
Brushed Bronze	Z9801TWBY0
Deep Black	Z9801TWDY0
Metallic Silver	Z9801TWMY0

SUMMARY ORDER... TO ACHIEVE THIS INSTALLATION ORDER THE FOLLOWING SUITE OF MODEL CODES

To combine a Full Touch 3 Flex Design Compact Oven with Microwave with a 14cm Drawer in Brushed Bronze with one optional Twist Pad Flex® order:

C29MY7MY0 Compact Oven
N29HA11Y1B 14cm Drawer
Z9060BY0 Flex Design Trim
Z9801TWBY0 Twist Pad Flex® (optional)

60cm Trim – Coffee Machine and Drawer

Coffee machine installed with 14cm drawer combination. The coffee machine requires an alternative 14cm warming drawer to install seamlessly - full details below.

STEP 1

CHOOSE YOUR COMPLETED COMBINATION

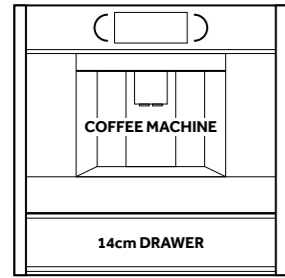

STEP 2

SUITABLE APPLIANCES

CHOOSE YOUR COMPACT OVEN

Collection	Display Size	Compact Oven Type	Model Number
N90	Full Touch 3	Compact Coffee Machine - Left Hinged Door	CL9TX11X0

CHOOSE YOUR DRAWER

Collection	Drawer Type	Model Number
N90 / N70	14cm Warming Drawer. For Seamless Installation with Coffee machine only.	N29HA11Y2

PLUS REQUIRED ACCESSORY

Accessory For Coffee	ZC060TY0
----------------------	----------

STEP 3

CHOOSE YOUR FLEX DESIGN TRIM. TRIM INCLUDES 2 X 60CM SIDE TRIMS

CHOOSE YOUR FLEX DESIGN TRIM

Finish	Model Number
Anthracite Grey	ZC060AY0
Brushed Bronze	ZC060BY0
Deep Black	ZC060DY0
Metallic Silver	ZC060MY0

SUMMARY ORDER...

TO ACHIEVE THIS INSTALLATION ORDER THE FOLLOWING SUITE OF MODEL CODES

To combine a Coffee machine with a 14cm Drawer in Brushed Bronze order:

CL9TX11X0 Coffee Machine
N29HA11Y2 14cm Warming Drawer
ZC060TY0 Accessory for installation
ZC060BY0 Flex Design Trim

75cm Trim – Single Oven and Drawer

60cm Single oven installed with 14cm drawer combination.

STEP 1

CHOOSE YOUR COMPLETED COMBINATION

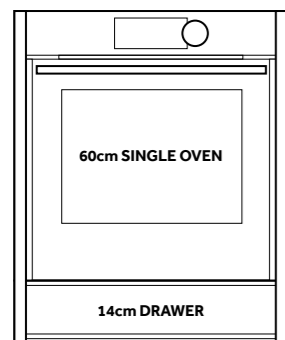

STEP 2

SUITABLE APPLIANCES

CHOOSE YOUR SINGLE OVEN

Collection	Display Size	Compact Oven Type	Model Number
N90	Full Touch 3	Slide and Hide® Single Pyrolytic Oven with Vario Steam®	B69VY7MY0
N90	Full Touch 3	Slide and Hide® Single Pyrolytic Oven	B69CY7MY0
N90	Full Touch 3	Slide and Hide® Single Oven with Intensive Steam	B69FY5CX0
N90	Full Touch 2	Slide and Hide® Single Pyrolytic Oven with Vario Steam®	B69VS7MY0A
N90	Full Touch 2	Slide and Hide® Single Pyrolytic Oven	B69CS7MY0B
N90	Full Touch 2	Slide and Hide® Single Oven with Intensive Steam	B69FS5CY0A
N70	Full Touch 1	Slide and Hide® Single Pyrolytic Oven	B59CR7KY0B

CHOOSE YOUR DRAWER

Collection	Drawer Type	Model Number
N90 / N70	14cm Warming Drawer	N29HA11Y1B

STEP 3

CHOOSE YOUR FLEX DESIGN TRIM. TRIM INCLUDES 2 X 75CM SIDE TRIMS AND 1 HANDLE.

CHOOSE YOUR FLEX DESIGN TRIM

Finish	Model Number
Anthracite Grey	Z9075AY0
Brushed Bronze	Z9075BY0
Deep Black	Z9075DY0
Metallic Silver	Z9075MY0

OPTIONAL ACCESSORY

Twist Pad Flex® is an additional accessory for Full Touch 3 appliances.

Finish	Model Number
Anthracite Grey	Z9801TWAY0
Brushed Bronze	Z9801TWBY0
Deep Black	Z9801TWDY0
Metallic Silver	Z9801TWMY0

SUMMARY ORDER...

TO ACHIEVE THIS INSTALLATION ORDER THE FOLLOWING SUITE OF MODEL CODES

To combine a single oven with a 14cm drawer in Deep Black order:

B69FS5CY0A Single Oven
N29HA11Y1B 14cm drawer
Z9075DY0 Flex Design Trim

75cm Trim – Compact Oven and 2 x Drawers

60cm Single oven installed with 29cm drawer combination.

STEP 1

CHOOSE YOUR COMPLETED COMBINATION

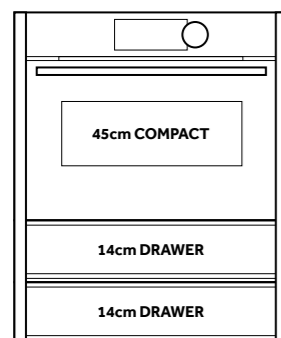

STEP 2

SUITABLE APPLIANCES

CHOOSE YOUR COMPACT OVEN

Collection	Display Size	Compact Oven Type	Model Number
N90	Full Touch 3	Compact Oven with Intensive Steam	C29FY5CX0
N90	Full Touch 3	Compact Oven with Microwave	C29MY7MY0
N90	Full Touch 2	Compact Oven with Intensive Steam	C29FS3AY0
N90	Full Touch 2	Compact Oven with Microwave	C29MS7KY0
N70	Full Touch 1	Compact Oven with Microwave	C29MR21Y0B

CHOOSE YOUR DRAWER

Collection	Drawer Type	Model Number
N90	14cm Warming Drawer	N29HA11Y1B

STEP 3

CHOOSE YOUR FLEX DESIGN TRIM. TRIM INCLUDES – 2 X 75CM SIDE TRIMS AND 1 HANDLE

CHOOSE YOUR FLEX DESIGN TRIM

Finish	Model Number
Anthracite Grey	Z9075AY0
Brushed Bronze	Z9075BY0
Deep Black	Z9075DY0
Metallic Silver	Z9075MY0

OPTIONAL ACCESSORY

Twist Pad Flex® is an additional accessory for Full Touch 3 appliances.

Finish	Model Number
Anthracite Grey	Z9801TWAY0
Brushed Bronze	Z9801TWBY0
Deep Black	Z9801TWDY0
Metallic Silver	Z9801TWMY0

SUMMARY ORDER...

TO ACHIEVE THIS INSTALLATION ORDER THE FOLLOWING SUITE OF MODEL CODES

To install a Compact oven and two 14cm drawers in Deep Black order:

B69FY5CX0 Compact Oven
N29HA11Y1B 14cm Warming Drawer

N29HA11Y1B 14cm Warming Drawer

Z9075DY0 Flex Design Trim

88cm Trim – Single Oven and 29cm Drawer

60cm Single oven installed with 29cm drawer combination.

STEP 1

CHOOSE YOUR COMPLETED COMBINATION

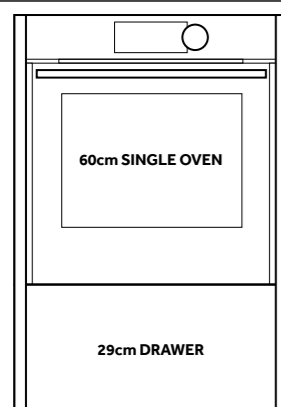

STEP 2

SUITABLE APPLIANCES

CHOOSE YOUR SINGLE OVEN

Collection	Display Size	Compact Oven Type	Model Number
N90	Full Touch 3	Slide and Hide® Single Pyrolytic Oven with Vario Steam®	B69VY7MY0
N90	Full Touch 3	Slide and Hide® Single Pyrolytic Oven	B69CY7MY0
N90	Full Touch 3	Slide and Hide® Single Oven with Intensive Steam	B69FY5CX0
N90	Full Touch 2	Slide and Hide® Single Pyrolytic Oven with Vario Steam®	B69VS7MY0A
N90	Full Touch 2	Slide and Hide® Single Pyrolytic Oven	B69CS7MY0B
N90	Full Touch 2	Slide and Hide® Single Oven with Intensive Steam	B69FS5CY0A
N70	Full Touch 1	Slide and Hide® Single Pyrolytic Oven	B59CR7KY0B

CHOOSE YOUR DRAWERS

Collection	Drawer Type	Model Number
N90 / N70	29cm Warming Drawer	N39HA11Y1B

STEP 3

CHOOSE YOUR FLEX DESIGN TRIM. TRIM INCLUDES 2 X 88CM SIDE TRIMS AND 1 HANDLE.

CHOOSE YOUR FLEX DESIGN TRIM

Finish	Model Number
Anthracite Grey	Z990AAAY0
Brushed Bronze	Z990ABY0
Deep Black	Z990ADY0
Metallic Silver	Z990AMY0

OPTIONAL ACCESSORY

Twist Pad Flex® is an additional accessory for Full Touch 3 appliances.

Finish	Model Number
Anthracite Grey	Z9801TWAY0
Brushed Bronze	Z9801TWBY0
Deep Black	Z9801TWDY0
Metallic Silver	Z9801TWMY0

SUMMARY ORDER...

TO ACHIEVE THIS INSTALLATION ORDER THE FOLLOWING SUITE OF MODEL CODES

To install a single oven and a deep 29cm warming drawer order in Metallic Silver order:

B59CR7KY0B Single Oven
N39HA11Y1B 29cm Warming Drawer

Z990AMY0 Flex Design Trim

88cm Trim – Compact Oven, 14cm Drawer and 29cm Drawer

Compact oven installed with a 14cm warming drawer and a 29cm warming drawer.

STEP 1

CHOOSE YOUR COMPLETED COMBINATION

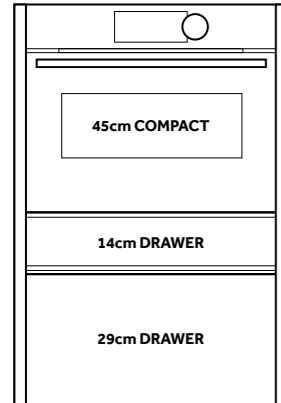

STEP 2

SUITABLE APPLIANCES

CHOOSE YOUR COMPACT OVEN

Collection	Display Size	Compact Oven Type	Model Number
N90	Full Touch 3	Compact Oven with Intensive Steam	C29FY5CX0
N90	Full Touch 3	Compact Oven with Microwave	C29MY7MY0
N90	Full Touch 2	Compact Oven with Intensive Steam	C29FS3AY0
N90	Full Touch 2	Compact Oven with Microwave	C29MS7KY0
N70	Full Touch 1	Compact Oven with Microwave	C29MR21Y0B

CHOOSE YOUR DRAWERS

Collection	Drawer Type	Model Number
N90 / N70	14cm Warming Drawer	N29HA11Y1B
N90 / N70	29cm Warming Drawer	N39HA11Y1B

Within this combination the 29cm and 14cm can also be done with the 14cm drawer on the bottom - please refer to p.48 for full details.

STEP 3

CHOOSE YOUR FLEX DESIGN TRIM. TRIM INCLUDES – 2 X 88CM SIDE TRIMS AND 1 HANDLE.

CHOOSE YOUR FLEX DESIGN TRIM

Finish	Model Number
Anthracite Grey	Z990AAAY0
Brushed Bronze	Z990ABY0
Deep Black	Z990ADY0
Metallic Silver	Z990AMY0

OPTIONAL ACCESSORY

Twist Pad Flex® is an additional accessory for Full Touch 3 appliances.

Finish	Model Number
Anthracite Grey	Z9801TWAY0
Brushed Bronze	Z9801TWBY0
Deep Black	Z9801TWDY0
Metallic Silver	Z9801TWMY0

SUMMARY ORDER...

TO ACHIEVE THIS INSTALLATION ORDER THE FOLLOWING SUITE OF MODEL CODES

To install a Compact Oven with a 14cm Warming Drawer and a 29cm Warming Drawer with Brushed Bronze trim order:

C29FY5CX0 Compact Oven
N29HA11Y1 14cm Warming Drawer
N39HA11Y1B 29cm Warming Drawer
Z990ABY0 Flex Design Trim

90cm Trim – 2x Compact Ovens

2x 45cm Compact ovens.

STEP 1

CHOOSE YOUR COMPLETED COMBINATION

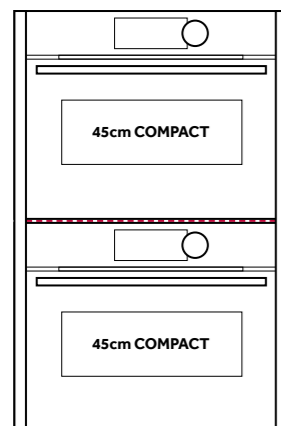

STEP 2

SUITABLE APPLIANCES

CHOOSE YOUR COMPACT OVEN

Collection	Display Size	Compact Oven Type	Model Number
N90	Full Touch 3	Compact Oven with Intensive Steam	C29FY5CX0
N90	Full Touch 3	Compact Oven with Microwave	C29MY7MY0
N90	Full Touch 2	Compact Oven with Intensive Steam	C29FS3AY0
N90	Full Touch 2	Compact Oven with Microwave	C29MS7KY0
N70	Full Touch 1	Compact Oven with Microwave	C29MR21Y0B

PLUS REQUIRED PLATFORM

When installing an oven on top of an oven this requires an intermediate platform.

Intermediate Platform	Z166CAX0
-----------------------	----------

STEP 3

CHOOSE YOUR FLEX DESIGN TRIM. TRIM INCLUDES – 2 X 90CM SIDE TRIMS AND 1 HANDLE

CHOOSE YOUR FLEX DESIGN TRIM

Finish	Model Number
Anthracite Grey	Z990BAY0
Brushed Bronze	Z990BBY0
Deep Black	Z990BDY0
Metallic Silver	Z990BMY0

OPTIONAL ACCESSORY

Twist Pad Flex® is an additional accessory for Full Touch 3 appliances.

Finish	Model Number
Anthracite Grey	Z9801TWAY0
Brushed Bronze	Z9801TWBY0
Deep Black	Z9801TWDY0
Metallic Silver	Z9801TWMY0

SUMMARY ORDER...

TO ACHIEVE THIS INSTALLATION ORDER THE FOLLOWING SUITE OF MODEL CODES

To order 2 Compact Ovens in Deep Black order:

C29FS3AY0 Compact Oven
C29MS7KY0 Compact Oven
Z166CAX0 Intermediate Platform
Z990BDY0 Flex Design Trim

98cm Trim – Microwave, Compact Oven and Drawer

38cm Microwave installed with a 45cm compact oven and 14cm drawer combination.

STEP 1

CHOOSE YOUR COMPLETED COMBINATION

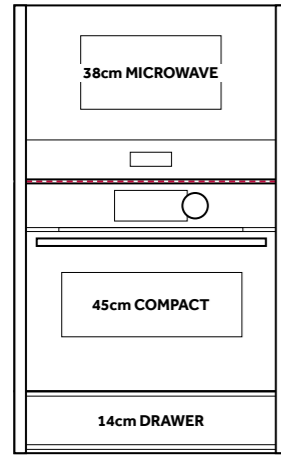

STEP 2

SUITABLE APPLIANCES

CHOOSE YOUR MICROWAVE OVEN

Collection	Display Size	Microwave Oven Type	Model Number
N70	Full Touch 1	38cm Microwave Oven - Left Hinged Door	NL9WR21Y1B
N70	Full Touch 1	38cm Microwave Oven - Right Hinged Door	NR9WR21Y1B

CHOOSE YOUR COMPACT OVEN

Collection	Display Size	Compact Oven Type	Model Number
N90	Full Touch 3	Compact Oven with Intensive Steam	C29FY5CX0
N90	Full Touch 3	Compact Oven with Microwave	C29MY7MY0
N90	Full Touch 2	Compact Oven with Intensive Steam	C29FS3AY0
N90	Full Touch 2	Compact Oven with Microwave	C29MS7KY0
N70	Full Touch 1	Compact Oven with Microwave	C29MR21Y0B

CHOOSE YOUR DRAWER

Collection	Drawer Type	Model Number
N90 / N70	14cm Warming Drawer	N29HA11Y1B

PLUS REQUIRED PLATFORM

Intermediate Platform	Z166CAX0
-----------------------	----------

STEP 3

CHOOSE YOUR FLEX DESIGN TRIM. TRIM INCLUDES – 2 X 98CM SIDE TRIMS AND 1 HANDLE

CHOOSE YOUR FLEX DESIGN TRIM

Finish	Model Number
Anthracite Grey	Z9098AY0
Brushed Bronze	Z9098BY0
Deep Black	Z9098DY0
Metallic Silver	Z9098MY0

OPTIONAL ACCESSORY

Twist Pad Flex® is an additional accessory for Full Touch 3 appliances.

Finish	Model Number
Anthracite Grey	Z9801TWAY0
Brushed Bronze	Z9801TWBY0
Deep Black	Z9801TWDY0
Metallic Silver	Z9801TWMY0

SUMMARY ORDER...

TO ACHIEVE THIS INSTALLATION ORDER THE FOLLOWING SUITE OF MODEL CODES

To install a 38cm microwave with a compact oven and 14cm drawer in Anthracite Grey order:

NL9WR21Y1B 38cm Microwave
C29MR21Y0B Compact Oven
N29HA11Y1B 14cm Warming Drawer
Z166CAX0 Intermediate Platform
Z9098AY0 Flex Design Trim

98cm Trim – Microwave and Single Oven

38cm Microwave installed with 60cm single oven combination.

STEP 1

CHOOSE YOUR COMPLETED COMBINATION

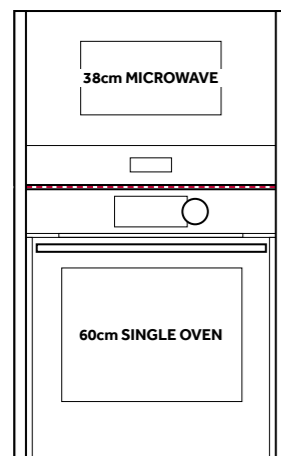

STEP 2

SUITABLE APPLIANCES

CHOOSE YOUR MICROWAVE OVEN

Collection	Display Size	Microwave Oven Type	Model Number
N70	Full Touch 1	38cm Microwave Oven - Left Hinged Door	NL9WR21Y1B
N70	Full Touch 1	38cm Microwave Oven - Right Hinged Door	NR9WR21Y1B

CHOOSE YOUR COMPACT OVEN

Collection	Display Size	Compact Oven Type	Model Number
N90	Full Touch 3	Compact Oven with Intensive Steam	C29FY5CX0
N90	Full Touch 3	Compact Oven with Microwave	C29MY7MY0
N90	Full Touch 2	Compact Oven with Intensive Steam	C29FS3AY0
N90	Full Touch 2	Compact Oven with Microwave	C29MS7KY0
N70	Full Touch 1	Compact Oven with Microwave	C29MR21Y0B

PLUS REQUIRED PLATFORM

Intermediate Platform	Z166CAX0
-----------------------	----------

STEP 3

CHOOSE YOUR FLEX DESIGN TRIM. TRIM INCLUDES – 2 X 73.5CM SIDE TRIMS AND 1 HANDLE

CHOOSE YOUR FLEX DESIGN TRIM

Finish	Model Number
Anthracite Grey	Z9098AY0
Brushed Bronze	Z9098BY0
Deep Black	Z9098DY0
Metallic Silver	Z9098MY0

OPTIONAL ACCESSORY

Twist Pad Flex® is an additional accessory for Full Touch 3 appliances.

Finish	Model Number
Anthracite Grey	Z9801TWAY0
Brushed Bronze	Z9801TWBY0
Deep Black	Z9801TWDY0
Metallic Silver	Z9801TWMY0

SUMMARY ORDER...

TO ACHIEVE THIS INSTALLATION ORDER THE FOLLOWING SUITE OF MODEL CODES

To order a 38cm Microwave and a Single Oven in Deep Black order:

NR9WR21Y1B 38cm Microwave
B59CR7KY0B Single Oven
Z166CAX0 Intermediate Platform
Z9098DY0 Flex Design Trim

105cm Trim – 2 x Compact Ovens and Drawer

2 x 45cm Compact ovens installed with a 14cm drawer combination.

STEP 1 CHOOSE YOUR COMPLETED COMBINATION

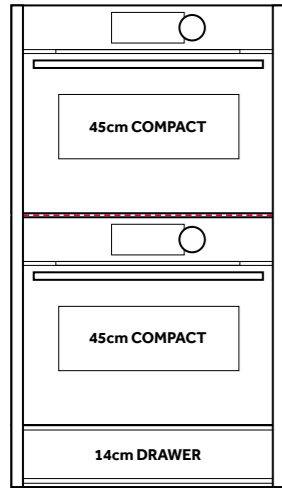

STEP 2 SUITABLE APPLIANCES

CHOOSE YOUR COMPACT OVEN			
Collection	Display Size	Compact Oven Type	Model Number
N90	Full Touch 3	Compact Oven with Intensive Steam	C29FY5CX0
N90	Full Touch 3	Compact Oven with Microwave	C29MY7MY0
N90	Full Touch 2	Compact Oven with Intensive Steam	C29FS3AY0
N90	Full Touch 2	Compact Oven with Microwave	C29MS7KY0
N70	Full Touch 1	Compact Oven with Microwave	C29MR21Y0B

CHOOSE YOUR DRAWER		
Collection	Drawer Type	Model Number
N90 / N70	14cm Warming Drawer	N29HA11Y1B

PLUS REQUIRED PLATFORM	
Intermediate Platform	Z166CAX0

STEP 3 CHOOSE YOUR FLEX DESIGN TRIM. TRIM INCLUDES – 2 X 105CM SIDE TRIMS AND 2 HANDLES

CHOOSE YOUR FLEX DESIGN TRIM	
Finish	Model Number
Anthracite Grey	Z9105AY0
Brushed Bronze	Z9105BY0
Deep Black	Z9105DY0
Metallic Silver	Z9105MY0

OPTIONAL ACCESSORY

Twist Pad Flex® is an additional accessory for Full Touch 3 appliances.

Finish	Model Number
Anthracite Grey	Z9801TWAY0
Brushed Bronze	Z9801TWBY0
Deep Black	Z9801TWDY0
Metallic Silver	Z9801TWMY0

SUMMARY ORDER... TO ACHIEVE THIS INSTALLATION ORDER THE FOLLOWING SUITE OF MODEL CODES

To install 2 compact ovens and a 14cm warming drawer in Deep Black order:

- C29FY5CX0** Compact Oven
- C29MY7MY0** Compact Oven
- N29HA11Y1B** 14cm Warming Drawer
- Z166CAX0** Intermediate Platform
- Z9105DY0** Flex Design Trim

105cm Trim – Compact Oven and Single Oven

45cm Compact oven installed with 60cm single oven combination.

STEP 1 CHOOSE YOUR COMPLETED COMBINATION

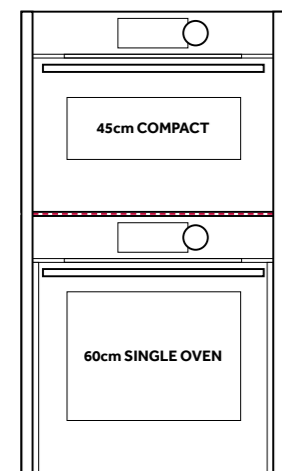

STEP 2 SUITABLE APPLIANCES

CHOOSE YOUR COMPACT OVEN				CHOOSE YOUR SINGLE OVEN			
Collection	Display Size	Compact Oven Type	Model Number	Collection	Display Size	Compact Oven Type	Model Number
N90	Full Touch 3	Compact Oven with Intensive Steam	C29FY5CX0	N90	Full Touch 3	Slide and Hide® Single Pyrolytic Oven with Vario Steam®	B69VY7MY0
N90	Full Touch 3	Compact Oven with Microwave	C29MY7MY0	N90	Full Touch 3	Slide and Hide® Single Pyrolytic Oven	B69CY7MY0
N90	Full Touch 2	Compact Oven with Intensive Steam	C29FS3AY0	N90	Full Touch 3	Slide and Hide® Single Oven with Intensive Steam	B69FY5CX0
N90	Full Touch 2	Compact Oven with Microwave	C29MS7KY0	N90	Full Touch 2	Slide and Hide® Single Pyrolytic Oven with Vario Steam®	B69VS7MY0A
N70	Full Touch 1	Compact Oven with Microwave	C29MR21Y0B	N90	Full Touch 2	Slide and Hide® Single Pyrolytic Oven	B69CS7MY0B
				N90	Full Touch 2	Slide and Hide® Single Oven with Intensive Steam	B69FS5CY0A
				N70	Full Touch 1	Slide and Hide® Single Pyrolytic Oven	B59CR7KY0B

PLUS REQUIRED PLATFORM	
Intermediate Platform	Z166CAX0

STEP 3 CHOOSE YOUR FLEX DESIGN TRIM. TRIM INCLUDES – 2 X 105CM SIDE TRIMS AND 2 X HANDLES

CHOOSE YOUR FLEX DESIGN TRIM	
Finish	Model Number
Anthracite Grey	Z9105AY0
Brushed Bronze	Z9105BY0
Deep Black	Z9105DY0
Metallic Silver	Z9105MY0

OPTIONAL ACCESSORY

Twist Pad Flex® is an additional accessory for Full Touch 3 appliances.

Finish	Model Number
Anthracite Grey	Z9801TWAY0
Brushed Bronze	Z9801TWBY0
Deep Black	Z9801TWDY0
Metallic Silver	Z9801TWMY0

SUMMARY ORDER... TO ACHIEVE THIS INSTALLATION ORDER THE FOLLOWING SUITE OF MODEL CODES

To install a compact oven with a single oven order in Brushed Bronze order:

- C29FS3AY0** Compact Oven
- B69CS7MY0B** Single Oven
- Z166CAX0** Intermediate Platform
- Z9105BY0** Flex Design Trim

120cm A Trim – Compact Oven, Single Oven and Drawer

A Compact oven with a single oven and a 14cm drawer.

STEP 1 CHOOSE YOUR COMPLETED COMBINATION

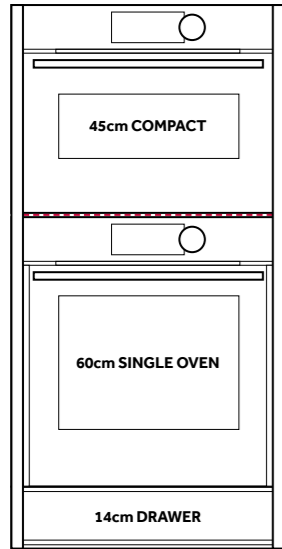

STEP 2 SUITABLE APPLIANCES

CHOOSE YOUR COMPACT OVEN			
Collection	Display Size	Compact Oven Type	Model Number
N90	Full Touch 3	Compact Oven with Intensive Steam	C29FY5CX0
N90	Full Touch 3	Compact Oven with Microwave	C29MY7MY0
N90	Full Touch 2	Compact Oven with Intensive Steam	C29FS3AY0
N90	Full Touch 2	Compact Oven with Microwave	C29MS7KY0
N70	Full Touch 1	Compact Oven with Microwave	C29MR21Y0B

CHOOSE YOUR SINGLE OVEN			
Collection	Display Size	Compact Oven Type	Model Number
N90	Full Touch 3	Slide and Hide® Single Pyrolytic Oven with Vario Steam®	B69VY7MY0
N90	Full Touch 3	Slide and Hide® Single Pyrolytic Oven	B69CY7MY0
N90	Full Touch 3	Slide and Hide® Single Oven with Intensive Steam	B69FY5CX0
N90	Full Touch 2	Slide and Hide® Single Pyrolytic Oven with Vario Steam®	B69VS7MY0A
N90	Full Touch 2	Slide and Hide® Single Pyrolytic Oven	B69CS7MY0B
N90	Full Touch 2	Slide and Hide® Single Oven with Intensive Steam	B69FS5CY0A
N70	Full Touch 1	Slide and Hide® Single Pyrolytic Oven	B59CR7KY0B

CHOOSE YOUR DRAWER		
Collection	Drawer Type	Model Number
N90 / N70	14cm Warming Drawer	N29HA11Y1B

PLUS REQUIRED PLATFORM	
Intermediate Platform	Z166CAX0

STEP 3 CHOOSE YOUR FLEX DESIGN TRIM. TRIM INCLUDES – 2 X 120CM SIDE TRIMS AND 2 HANDLES

CHOOSE YOUR FLEX DESIGN TRIM	
Finish	Model Number
Anthracite Grey	Z912AAAY0
Brushed Bronze	Z912ABY0
Deep Black	Z912ADY0
Metallic Silver	Z912AMY0

OPTIONAL ACCESSORY

Twist Pad Flex® is an additional accessory for Full Touch 3 appliances.

Finish	Model Number
Anthracite Grey	Z9801TWAY0
Brushed Bronze	Z9801TWBY0
Deep Black	Z9801TWDY0
Metallic Silver	Z9801TWMY0

SUMMARY ORDER... TO ACHIEVE THIS INSTALLATION ORDER THE FOLLOWING SUITE OF MODEL CODES

To install a Compact oven, a Single oven and a 14cm Warming drawer in Brushed Bronze order:

- C29MY7MY0** Compact Oven
- B69FY5CX0** Single Oven
- N29HA11Y1B** 14cm Warming Drawer
- Z166CAX0** Intermediate Platform
- Z912ABY0** Flex Design Trim

120cm A Trim – 2 x Compact Oven and 2 x Drawer

2 x Compact oven installed with 2 x 14cm drawer combination.

STEP 1 CHOOSE YOUR COMPLETED COMBINATION

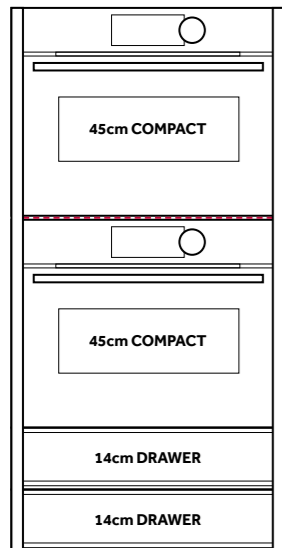

STEP 2 SUITABLE APPLIANCES

CHOOSE YOUR COMPACT OVEN			
Collection	Display Size	Compact Oven Type	Model Number
N90	Full Touch 3	Compact Oven with Intensive Steam	C29FY5CX0
N90	Full Touch 3	Compact Oven with Microwave	C29MY7MY0
N90	Full Touch 2	Compact Oven with Intensive Steam	C29FS3AY0
N90	Full Touch 2	Compact Oven with Microwave	C29MS7KY0
N70	Full Touch 1	Compact Oven with Microwave	C29MR21Y0B

CHOOSE YOUR DRAWER		
Collection	Drawer Type	Model Number
N90 / N70	14cm Warming Drawer	N29HA11Y1B

PLUS REQUIRED PLATFORM	
Intermediate Platform	Z166CAX0

STEP 3 CHOOSE YOUR FLEX DESIGN TRIM. TRIM INCLUDES – 2 X 120CM SIDE TRIMS AND 2 HANDLES

CHOOSE YOUR FLEX DESIGN TRIM	
Finish	Model Number
Anthracite Grey	Z912AAAY0
Brushed Bronze	Z912ABY0
Deep Black	Z912ADY0
Metallic Silver	Z912AMY0

OPTIONAL ACCESSORY

Twist Pad Flex® is an additional accessory for Full Touch 3 appliances.

Finish	Model Number
Anthracite Grey	Z9801TWAY0
Brushed Bronze	Z9801TWBY0
Deep Black	Z9801TWDY0
Metallic Silver	Z9801TWMY0

SUMMARY ORDER... TO ACHIEVE THIS INSTALLATION ORDER THE FOLLOWING SUITE OF MODEL CODES

2 x Compact Ovens and 2 x 14cm Drawers in Deep Black order:

- C29FS3AY0** Compact Oven
- C29MS7KY0** Compact Oven
- N29HA11Y1B** 14cm Warming Drawer
- N29HA11Y1B** 14cm Warming Drawer
- Z166CAX0** Intermediate Platform
- Z912ADY0** Flex Design Trim

120cm B Trim – 2 x Single Ovens

2x Single ovens installed.

STEP 1 CHOOSE YOUR COMPLETED COMBINATION

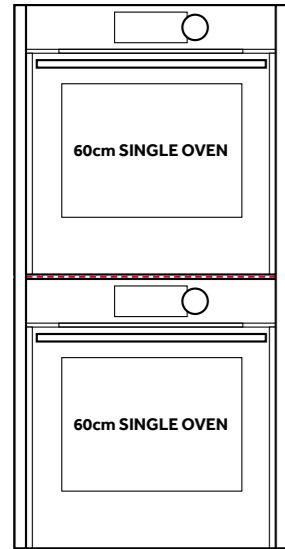

STEP 2 SUITABLE APPLIANCES

CHOOSE YOUR SINGLE OVEN

Collection	Display Size	Compact Oven Type	Model Number
N90	Full Touch 3	Slide and Hide® Single Pyrolytic Oven with Vario Steam®	B69VY7MY0
N90	Full Touch 3	Slide and Hide® Single Pyrolytic Oven	B69CY7MY0
N90	Full Touch 3	Slide and Hide® Single Oven with Intensive Steam	B69FY5CX0
N90	Full Touch 2	Slide and Hide® Single Pyrolytic Oven with Vario Steam®	B69VS7MY0A
N90	Full Touch 2	Slide and Hide® Single Pyrolytic Oven	B69CS7MY0B
N90	Full Touch 2	Slide and Hide® Single Oven with Intensive Steam	B69FS5CY0A
N70	Full Touch 1	Slide and Hide® Single Pyrolytic Oven	B59CR7KY0B

PLUS REQUIRED PLATFORM

Intermediate Platform	Z166CAX0
-----------------------	----------

STEP 3

CHOOSE YOUR FLEX DESIGN TRIM. TRIM INCLUDES – 2 X 120CM SIDE TRIMS AND 2 X HANDLES

CHOOSE YOUR FLEX DESIGN TRIM

Finish	Model Number
Anthracite Grey	Z912BAY0
Brushed Bronze	Z912BBY0
Deep Black	Z912BDY0
Metallic Silver	Z912BMY0

OPTIONAL ACCESSORY

Twist Pad Flex® is an additional accessory for Full Touch 3 appliances.

Finish	Model Number
Anthracite Grey	Z9801TWAY0
Brushed Bronze	Z9801TWBY0
Deep Black	Z9801TWDY0
Metallic Silver	Z9801TWMY0

SUMMARY ORDER...

TO ACHIEVE THIS INSTALLATION ORDER THE FOLLOWING SUITE OF MODEL CODES

To install 2 x Single Ovens with Metallic Silver Trim order:

- B69VS7MY0A** Single Oven
- B69CS7MY0B** Single Oven
- Z166CAX0** Intermediate Platform
- Z912BMY0** Flex Design Trim

120cm B Trim – Single Oven, Compact Oven and Drawer

Single oven with a compact oven and a 14cm drawer.

STEP 1 CHOOSE YOUR COMPLETED COMBINATION

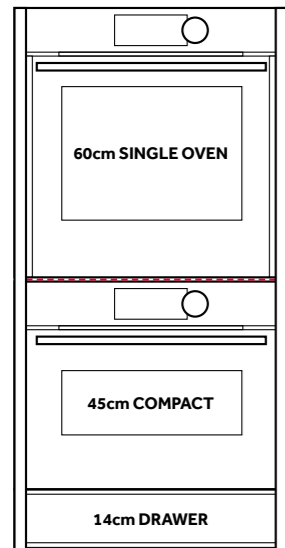

STEP 2 SUITABLE APPLIANCES

CHOOSE YOUR SINGLE OVEN

Collection	Display Size	Compact Oven Type	Model Number
N90	Full Touch 3	Slide and Hide® Single Pyrolytic Oven with Vario Steam®	B69VY7MY0
N90	Full Touch 3	Slide and Hide® Single Pyrolytic Oven	B69CY7MY0
N90	Full Touch 3	Slide and Hide® Single Oven with Intensive Steam	B69FY5CX0
N90	Full Touch 2	Slide and Hide® Single Pyrolytic Oven with Vario Steam®	B69VS7MY0A
N90	Full Touch 2	Slide and Hide® Single Pyrolytic Oven	B69CS7MY0B
N90	Full Touch 2	Slide and Hide® Single Oven with Intensive Steam	B69FS5CY0A
N70	Full Touch 1	Slide and Hide® Single Pyrolytic Oven	B59CR7KY0B

CHOOSE YOUR COMPACT OVEN

Collection	Display Size	Compact Oven Type	Model Number
N90	Full Touch 3	Compact Oven with Intensive Steam	C29FY5CX0
N90	Full Touch 3	Compact Oven with Microwave	C29MY7MY0
N90	Full Touch 2	Compact Oven with Intensive Steam	C29FS3AY0
N90	Full Touch 2	Compact Oven with Microwave	C29MS7KY0
N70	Full Touch 1	Compact Oven with Microwave	C29MR21Y0B

CHOOSE YOUR DRAWER

Collection	Drawer Type	Model Number
N90 / N70	14cm Warming Drawer	N29HA11Y1B

PLUS REQUIRED PLATFORM

Intermediate Platform	Z166CAX0
-----------------------	----------

STEP 3

CHOOSE YOUR FLEX DESIGN TRIM. TRIM INCLUDES – 2 X 120CM SIDE TRIMS AND 2 X HANDLES

CHOOSE YOUR FLEX DESIGN TRIM

Finish	Model Number
Anthracite Grey	Z912BAY0
Brushed Bronze	Z912BBY0
Deep Black	Z912BDY0
Metallic Silver	Z912BMY0

OPTIONAL ACCESSORY

Twist Pad Flex® is an additional accessory for Full Touch 3 appliances.

Finish	Model Number
Anthracite Grey	Z9801TWAY0
Brushed Bronze	Z9801TWBY0
Deep Black	Z9801TWDY0
Metallic Silver	Z9801TWMY0

SUMMARY ORDER...

TO ACHIEVE THIS INSTALLATION ORDER THE FOLLOWING SUITE OF MODEL CODES

To install a Single Oven, a compact oven with a 14cm Drawer in Anthracite Grey order:

- B69CY7MY0** Single Oven
- C29MY7MY0** Compact Oven
- N29HA11Y1B** 14cm Warming Drawer
- Z166CAX0** Intermediate Platform
- Z912BAY0** Flex Design Trim

120cm B Trim – Compact, Drawer and Single Oven

Compact oven installed with 14cm drawer and single oven combination.

STEP 1 CHOOSE YOUR COMPLETED COMBINATION

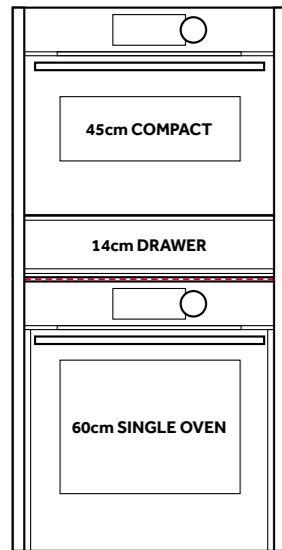

STEP 2 SUITABLE APPLIANCES

CHOOSE YOUR COMPACT OVEN			
Collection	Display Size	Compact Oven Type	Model Number
N90	Full Touch 3	Compact Oven with Intensive Steam	C29FY5CX0
N90	Full Touch 3	Compact Oven with Microwave	C29MY7MY0
N90	Full Touch 2	Compact Oven with Intensive Steam	C29FS3AY0
N90	Full Touch 2	Compact Oven with Microwave	C29MS7KY0
N70	Full Touch 1	Compact Oven with Microwave	C29MR21Y0B

CHOOSE YOUR SINGLE OVEN			
Collection	Display Size	Compact Oven Type	Model Number
N90	Full Touch 3	Slide and Hide® Single Pyrolytic Oven with Vario Steam®	B69VY7MY0
N90	Full Touch 3	Slide and Hide® Single Pyrolytic Oven	B69CY7MY0
N90	Full Touch 3	Slide and Hide® Single Oven with Intensive Steam	B69FY5CX0
N90	Full Touch 2	Slide and Hide® Single Pyrolytic Oven with Vario Steam®	B69VS7MY0A
N90	Full Touch 2	Slide and Hide® Single Pyrolytic Oven	B69CS7MY0B
N90	Full Touch 2	Slide and Hide® Single Oven with Intensive Steam	B69FS5CY0A
N70	Full Touch 1	Slide and Hide® Single Pyrolytic Oven	B59CR7KY0B

CHOOSE YOUR DRAWER		
Collection	Drawer Type	Model Number
N90 / N70	14cm Warming Drawer	N29HA11Y1B

PLUS REQUIRED PLATFORM	
Intermediate Platform	Z166CAX0

STEP 3 CHOOSE YOUR FLEX DESIGN TRIM. TRIM INCLUDES – 2 X 120CM SIDE TRIMS AND 2 X HANDLES

CHOOSE YOUR FLEX DESIGN TRIM	
Finish	Model Number
Anthracite Grey	Z912BAY0
Brushed Bronze	Z912BBY0
Deep Black	Z912BDY0
Metallic Silver	Z912BMY0

OPTIONAL ACCESSORY

Twist Pad Flex® is an additional accessory for Full Touch 3 appliances.

Finish	Model Number
Anthracite Grey	Z9801TWAY0
Brushed Bronze	Z9801TWBY0
Deep Black	Z9801TWDY0
Metallic Silver	Z9801TWMY0

SUMMARY ORDER... TO ACHIEVE THIS INSTALLATION ORDER THE FOLLOWING SUITE OF MODEL CODES

To install a compact oven, a 14cm drawer, a single oven in Deep Black order:

- C29MR21Y0B** Compact Oven
- N29HA11Y1B** 14cm Warming Drawer
- B59CR7KY0B** Single Oven
- Z166CAX0** Intermediate Platform
- Z912BDY0** Flex Design Trim

120cm B Trim – 2 x Compact and 2 x Drawer

2 x Compact ovens installed with 2 x 14cm drawers.

STEP 1 CHOOSE YOUR COMPLETED COMBINATION

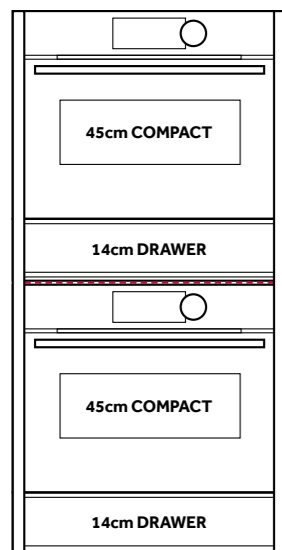

STEP 2 SUITABLE APPLIANCES

CHOOSE YOUR COMPACT OVEN			
Collection	Display Size	Compact Oven Type	Model Number
N90	Full Touch 3	Compact Oven with Intensive Steam	C29FY5CX0
N90	Full Touch 3	Compact Oven with Microwave	C29MY7MY0
N90	Full Touch 2	Compact Oven with Intensive Steam	C29FS3AY0
N90	Full Touch 2	Compact Oven with Microwave	C29MS7KY0
N70	Full Touch 1	Compact Oven with Microwave	C29MR21Y0B

CHOOSE YOUR DRAWER		
Collection	Drawer Type	Model Number
N90 / N70	14cm Warming Drawer	N29HA11Y1B

PLUS REQUIRED PLATFORM	
Intermediate Platform	Z166CAX0

STEP 3 CHOOSE YOUR FLEX DESIGN TRIM. TRIM INCLUDES – 2 X 120CM SIDE TRIMS AND 2 HANDLES

CHOOSE YOUR FLEX DESIGN TRIM	
Finish	Model Number
Anthracite Grey	Z912BAY0
Brushed Bronze	Z912BBY0
Deep Black	Z912BDY0
Metallic Silver	Z912BMY0

OPTIONAL ACCESSORY

Twist Pad Flex® is an additional accessory for Full Touch 3 appliances.

Finish	Model Number
Anthracite Grey	Z9801TWAY0
Brushed Bronze	Z9801TWBY0
Deep Black	Z9801TWDY0
Metallic Silver	Z9801TWMY0

SUMMARY ORDER... TO ACHIEVE THIS INSTALLATION ORDER THE FOLLOWING SUITE OF MODEL CODES

To install a Compact oven and a 14cm drawer on top of another compact oven and a 14cm drawer in Brushed Bronze order:

- C29MS7KY0** Compact Oven
- N29HA11Y1B** 14cm Warming Drawer
- C29FS3AY0** Compact Oven
- N29HA11Y1B** 14cm Warming Drawer
- Z166CAX0** Intermediate Platform
- Z912BBY0** Flex Design Trim

How to install your appliances

60cm Seamless Combination

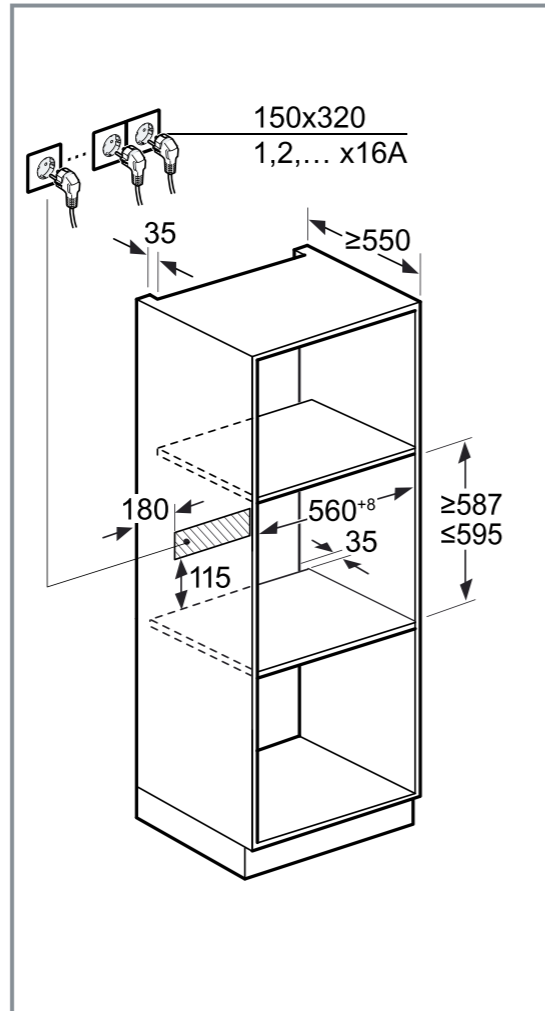
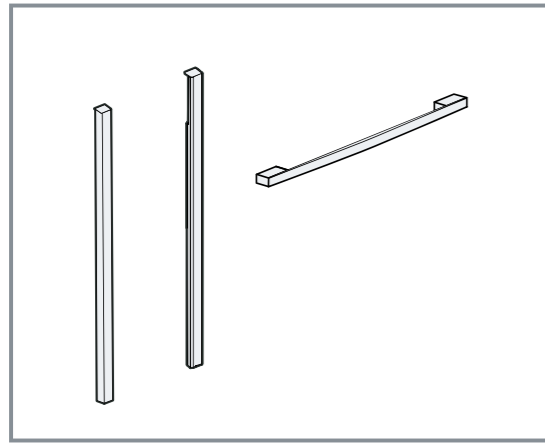
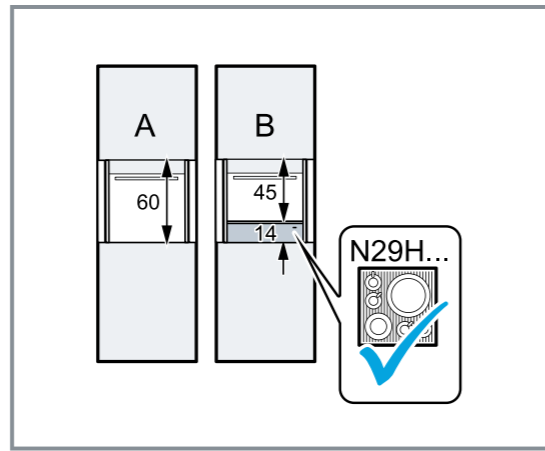
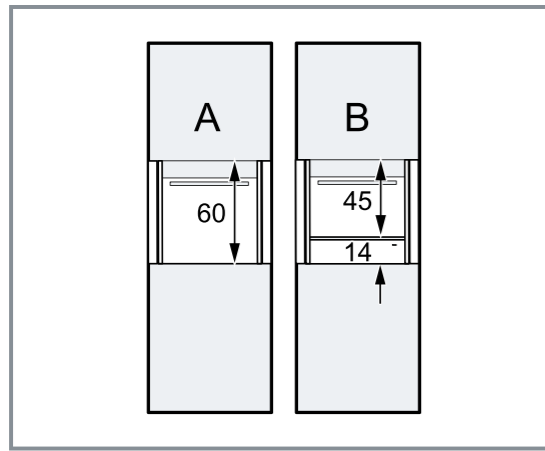

75cm Seamless Combination

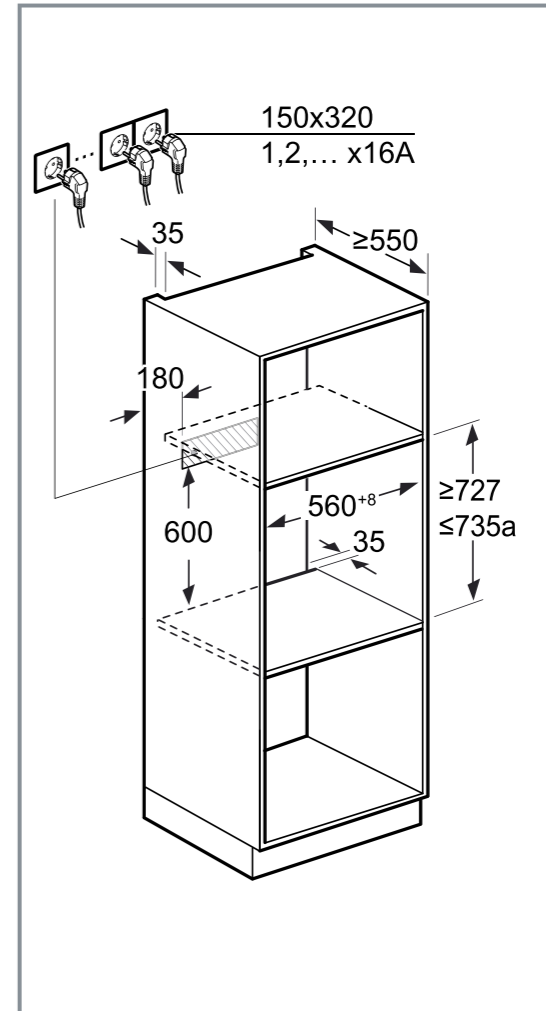
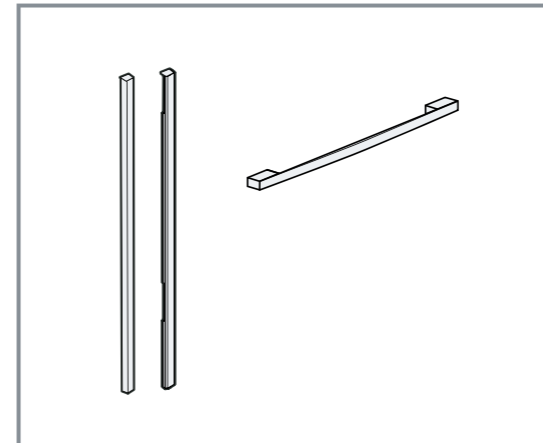
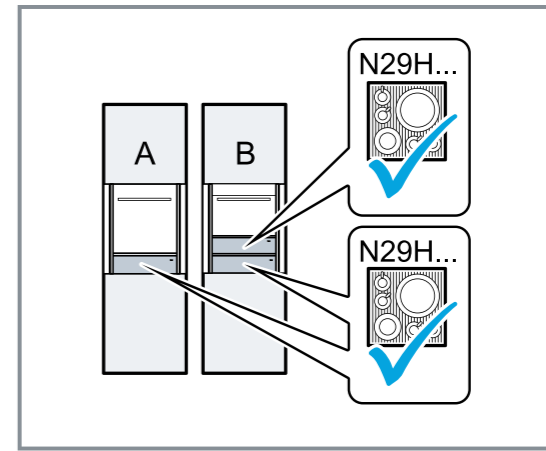
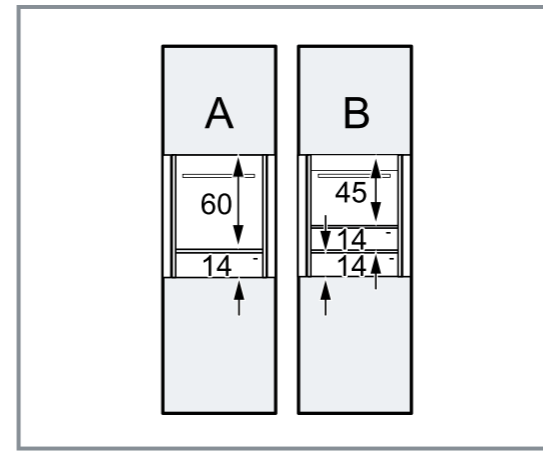

88cm Seamless Combination

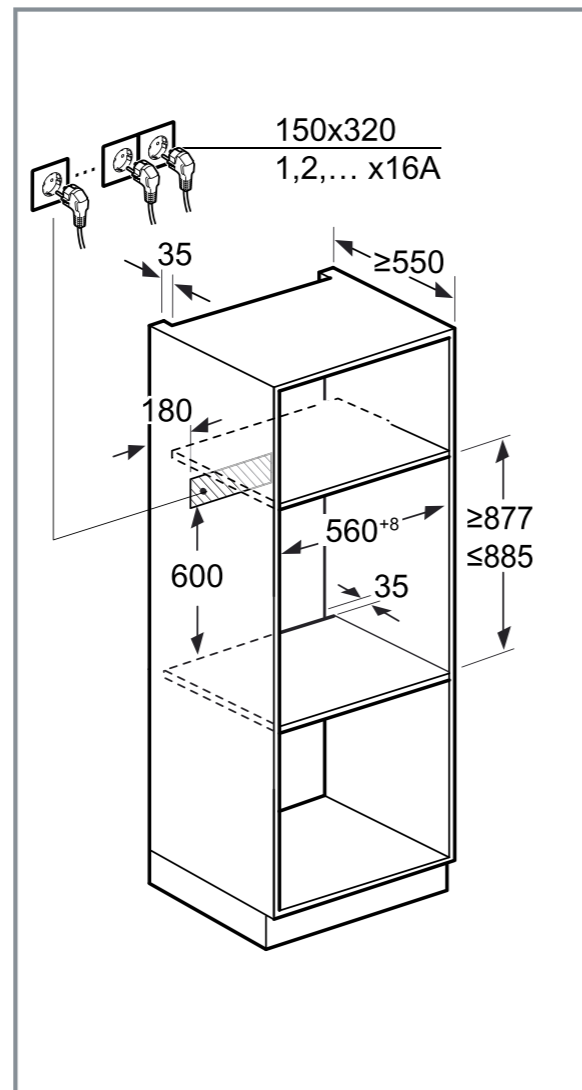
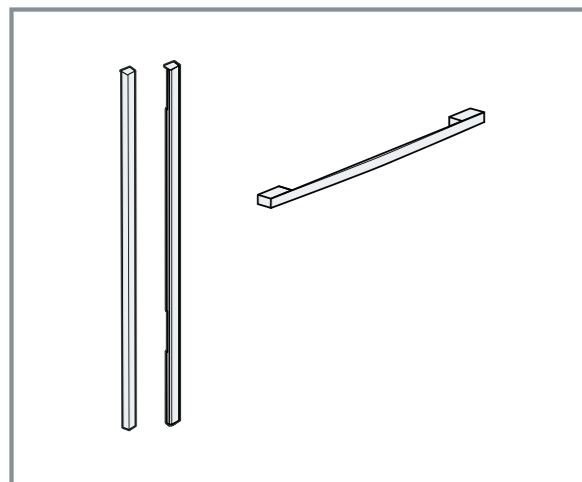
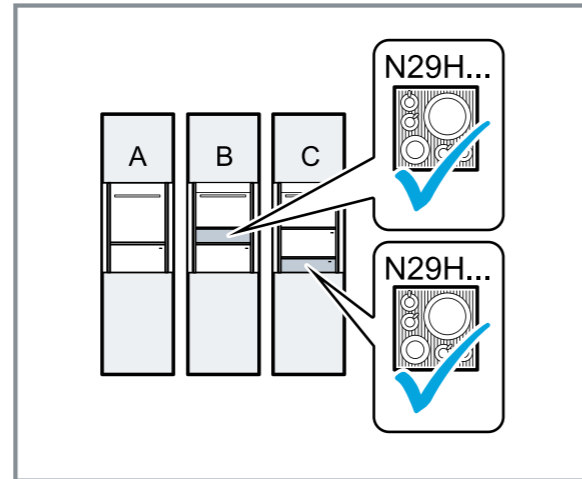
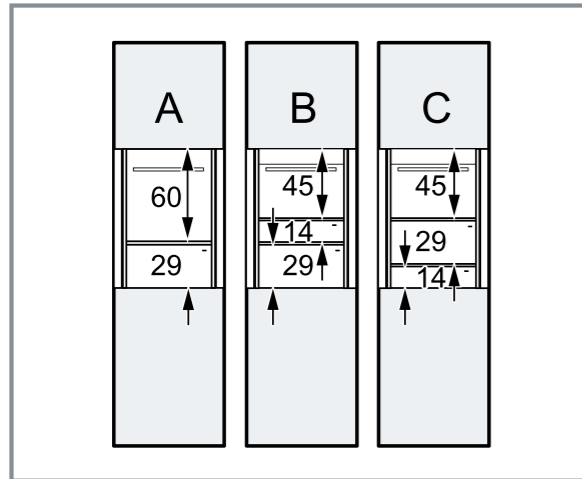

90cm Seamless Combination

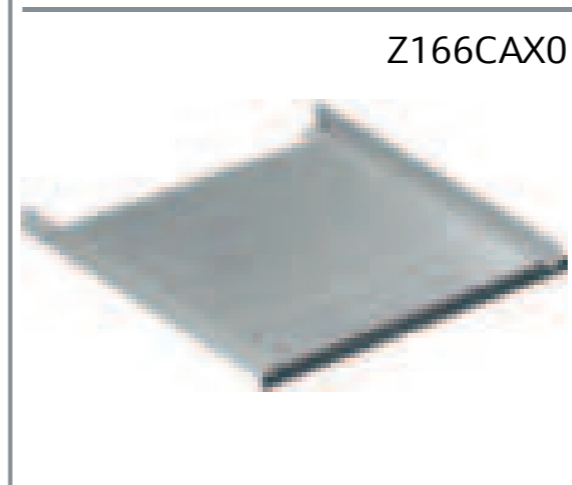
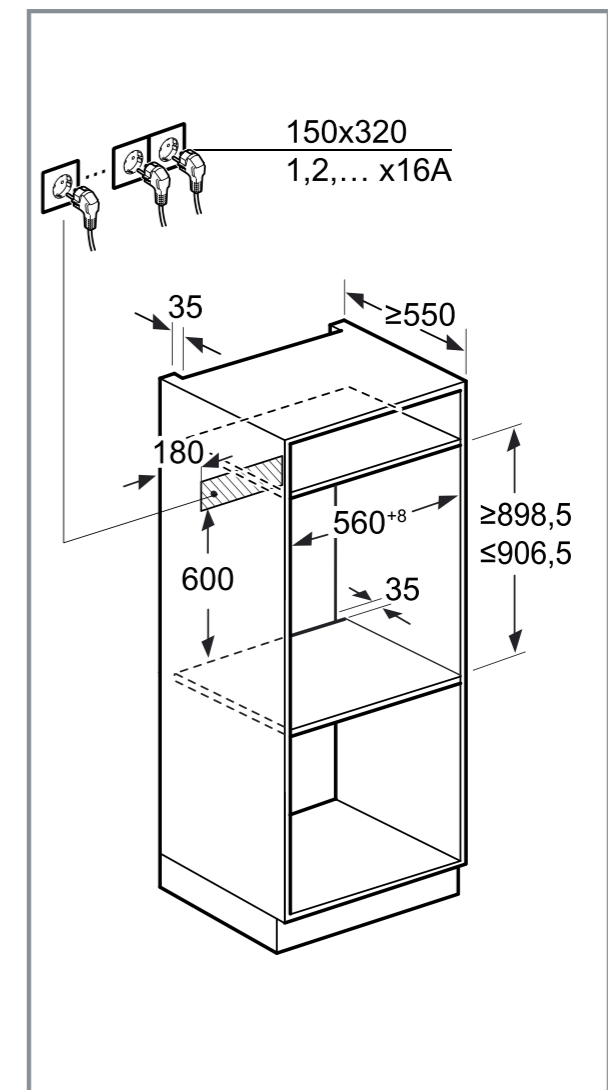
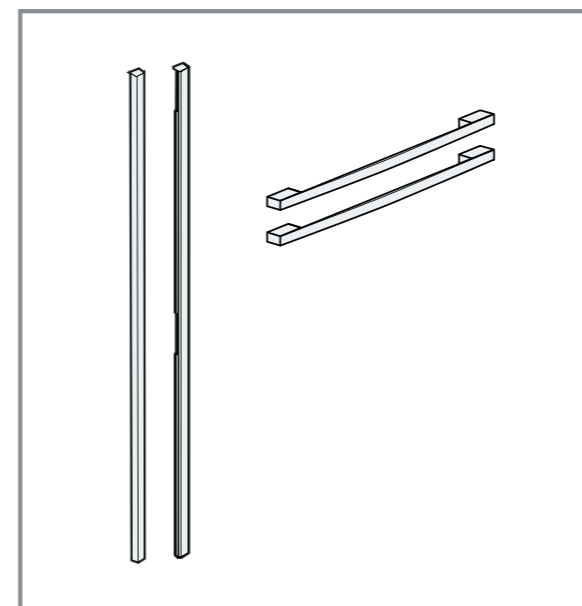
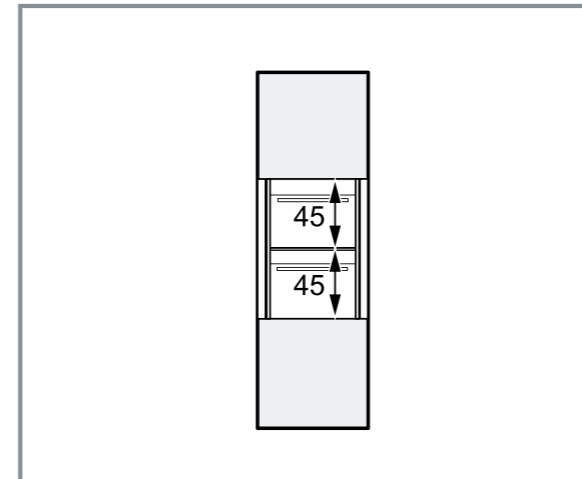

98cm Seamless Combination

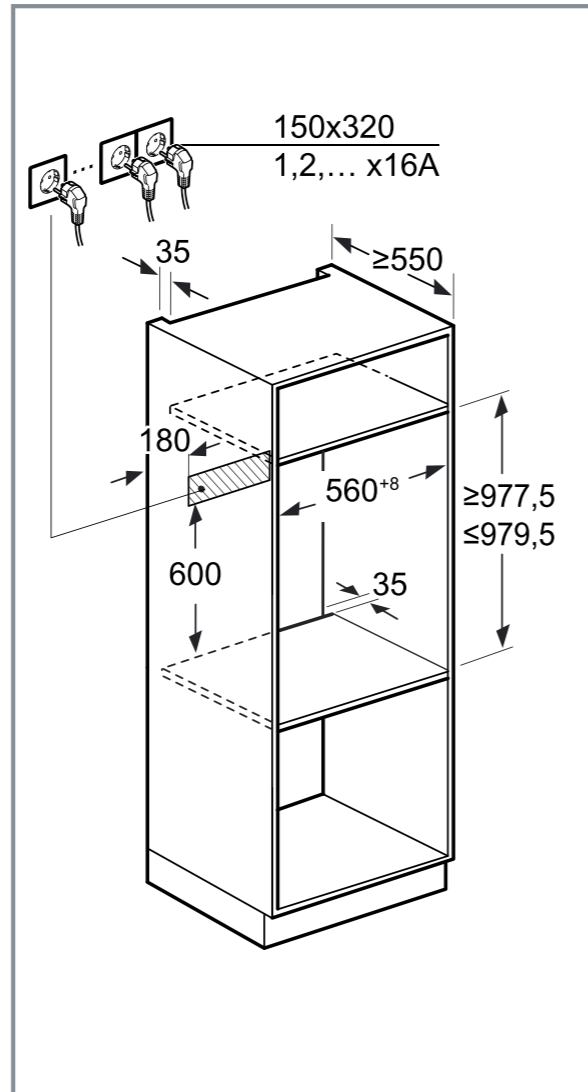
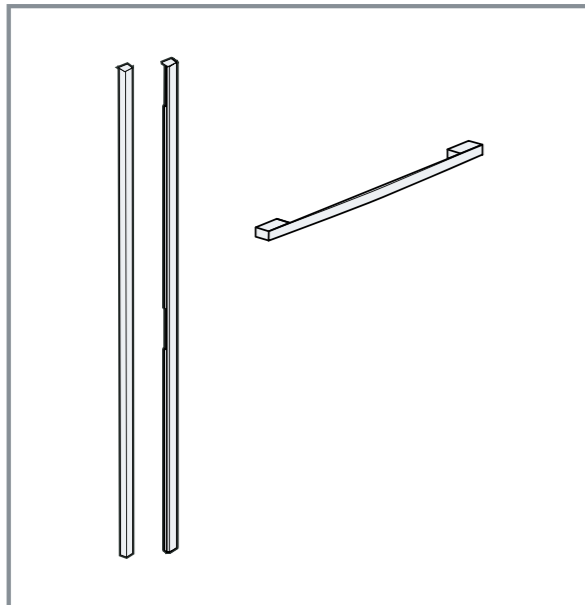
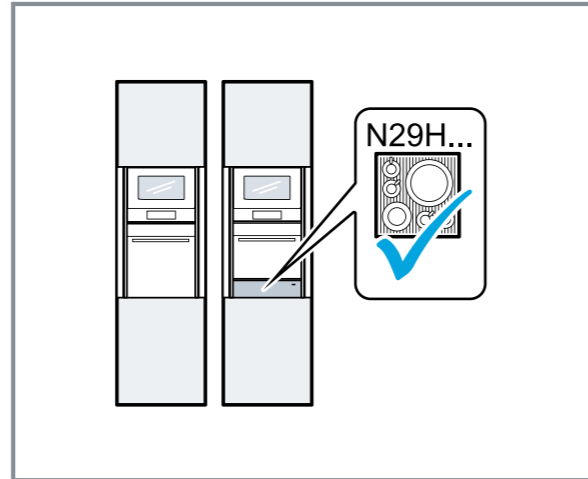
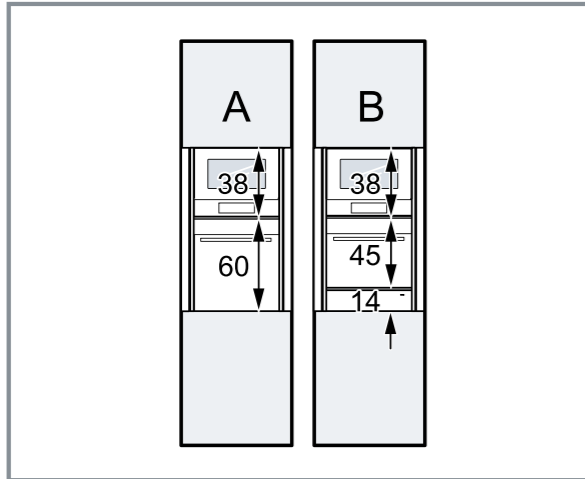

Z166CAX0



105cm Seamless Combination

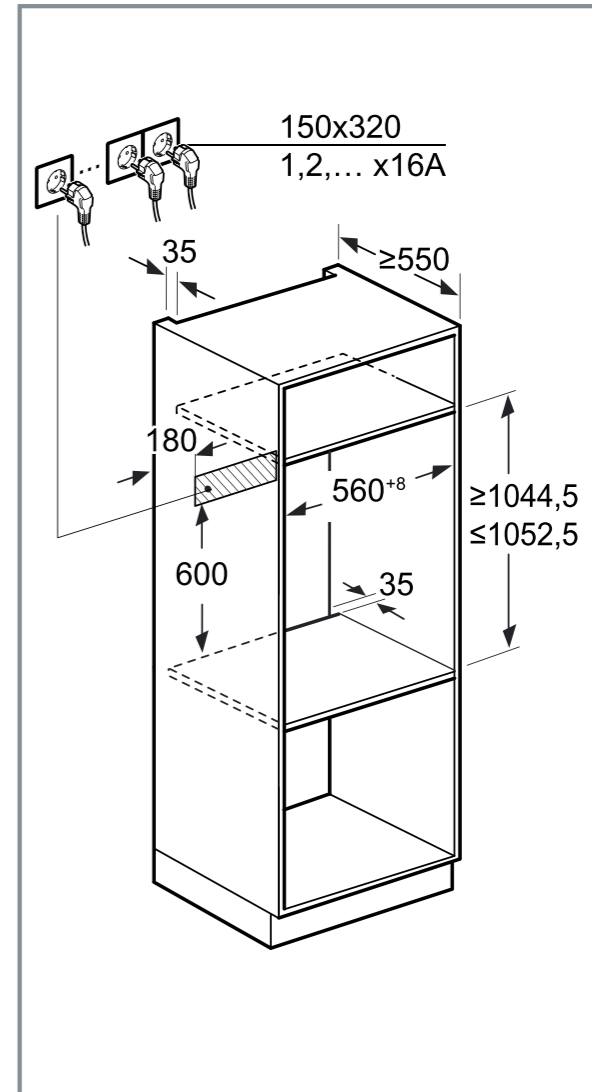
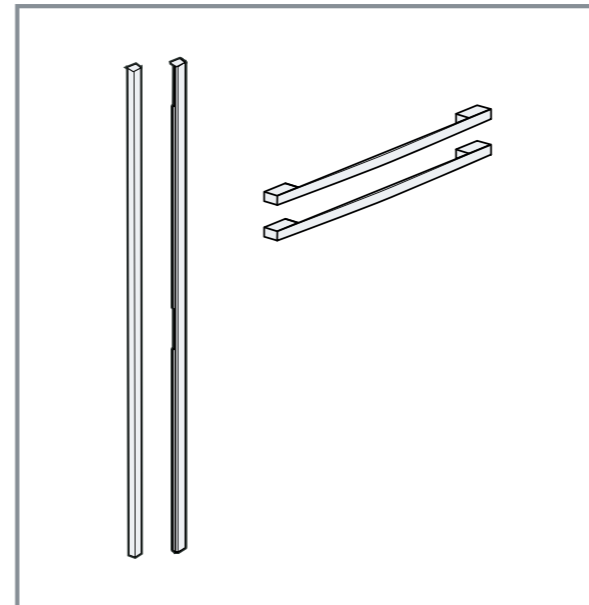
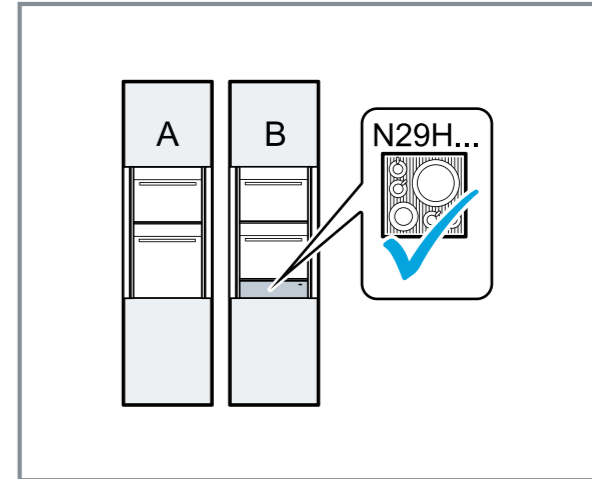
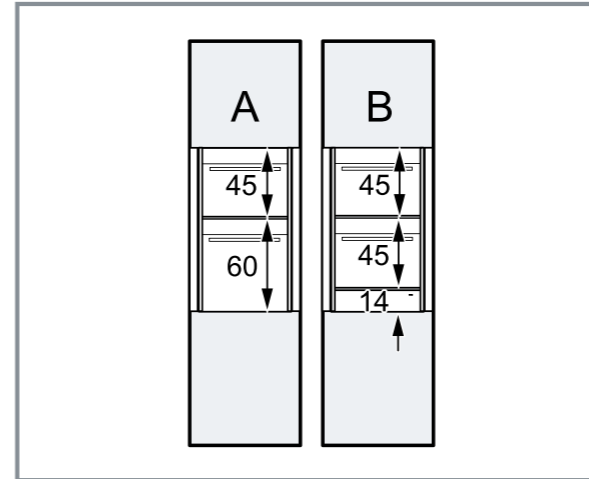

Z166CAX0



120cm A Seamless Combination

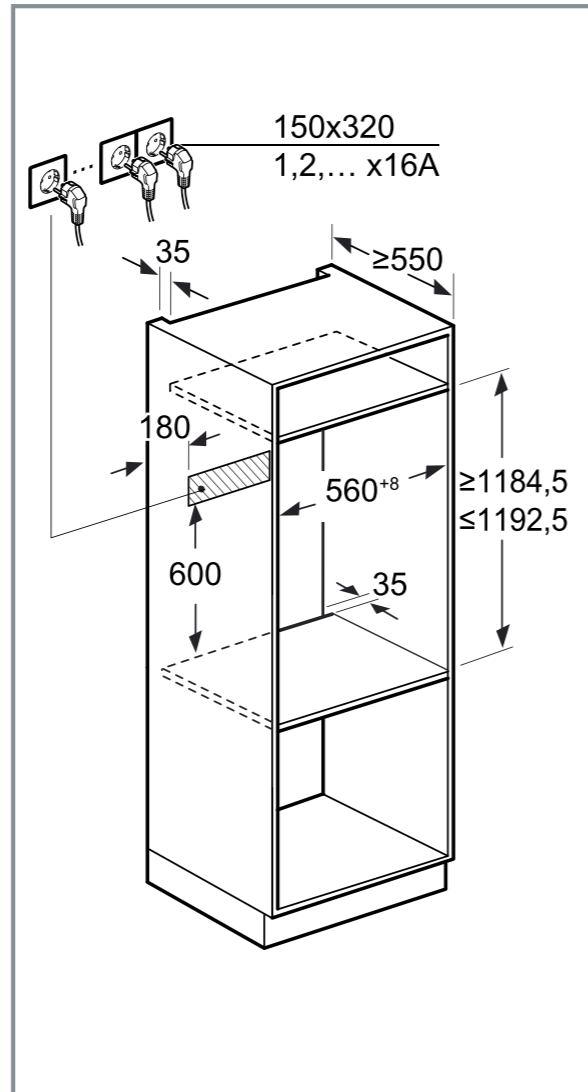
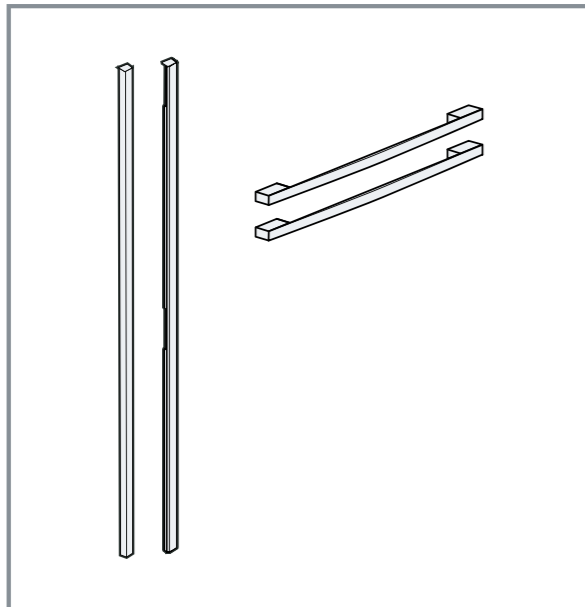
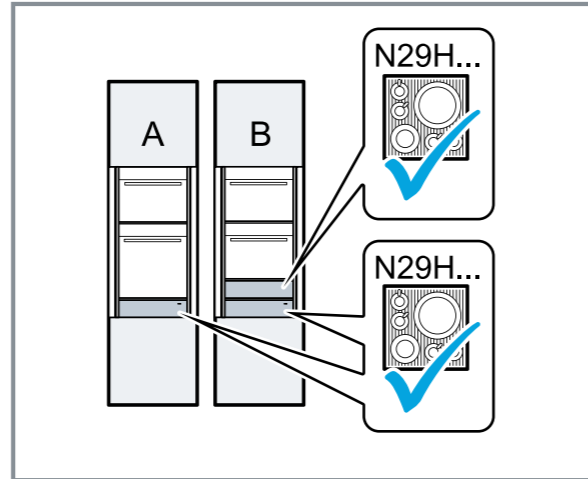
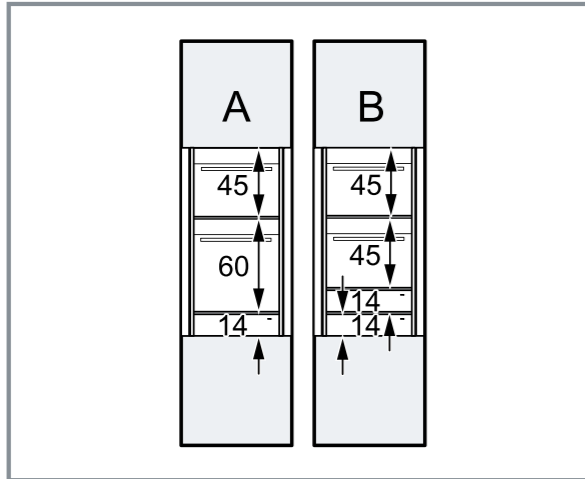

Z166CAX0



120cm B Seamless Combination

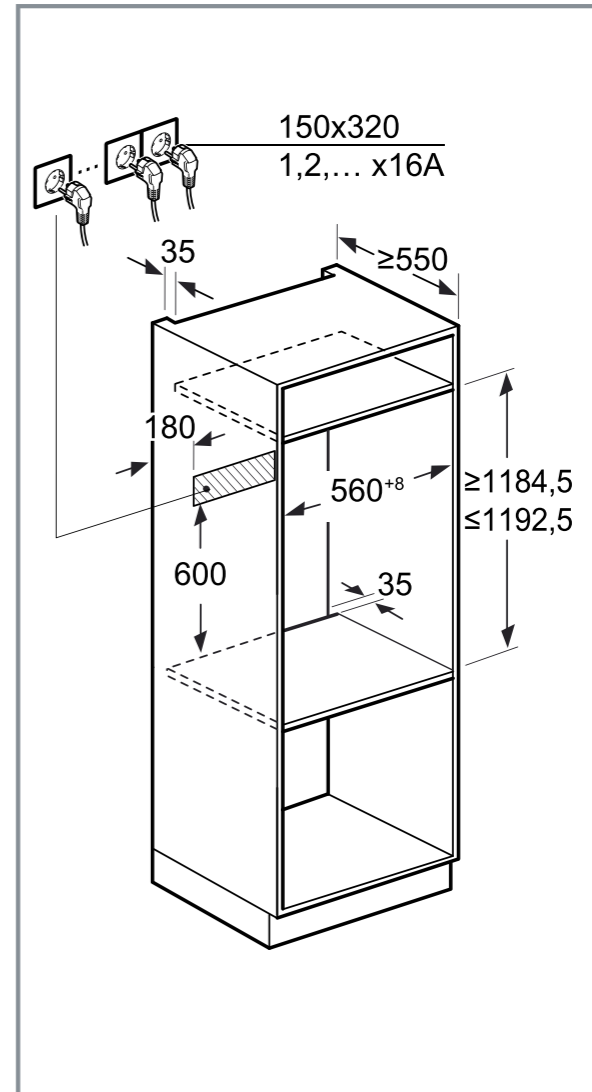
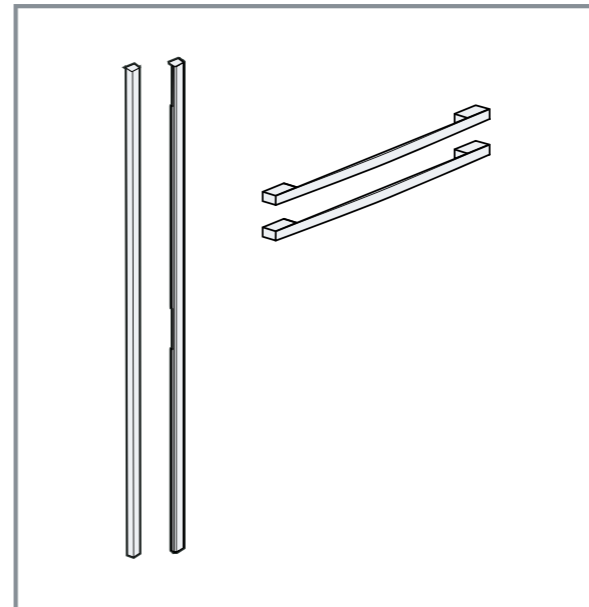
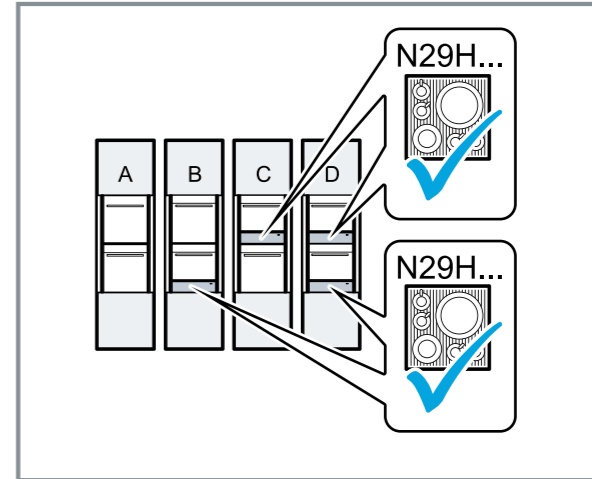
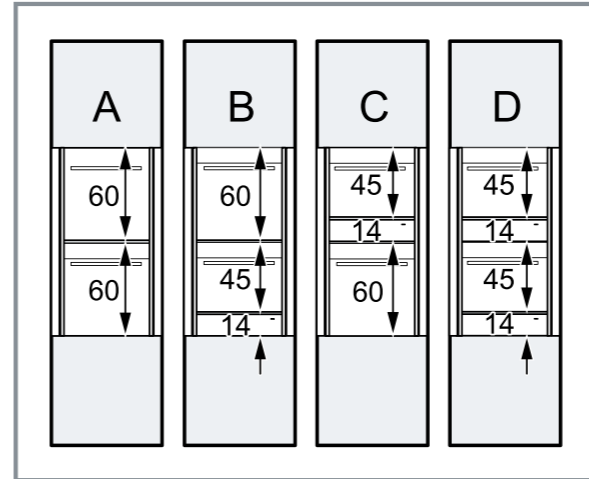

Z166CAX0



Flex Design Ovens

60CM
B69FY5CX0



60CM
B69VY7MY0
B69CY7MY0
B69FS5CY0A
B69VS7MY0A
B69CS7MY0B
B59CR7KY0B



45CM
C29FY5CX0



As per table in 200 view

14CM WARMING DRAWERS
N29HA11Y1B
N29HA11Y2



29CM WARMING DRAWERS
N39HA11Y1B



45CM
C29MY7MY0 / C29MS7KY0 / C29MR21Y0B

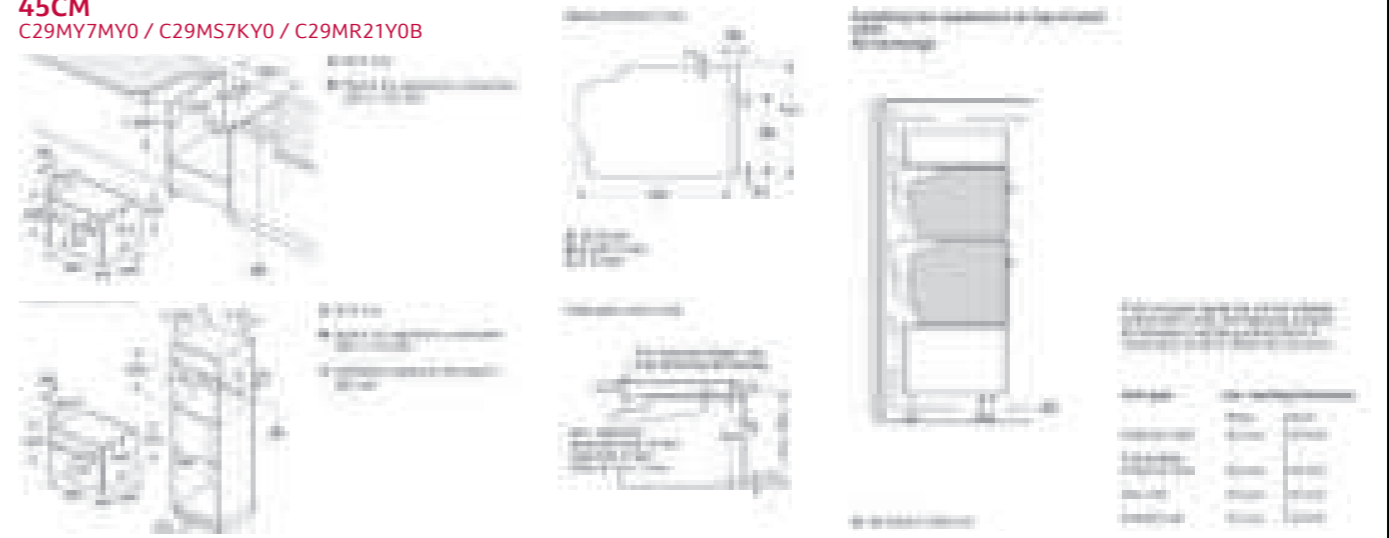

45CM
CL9TX11X0

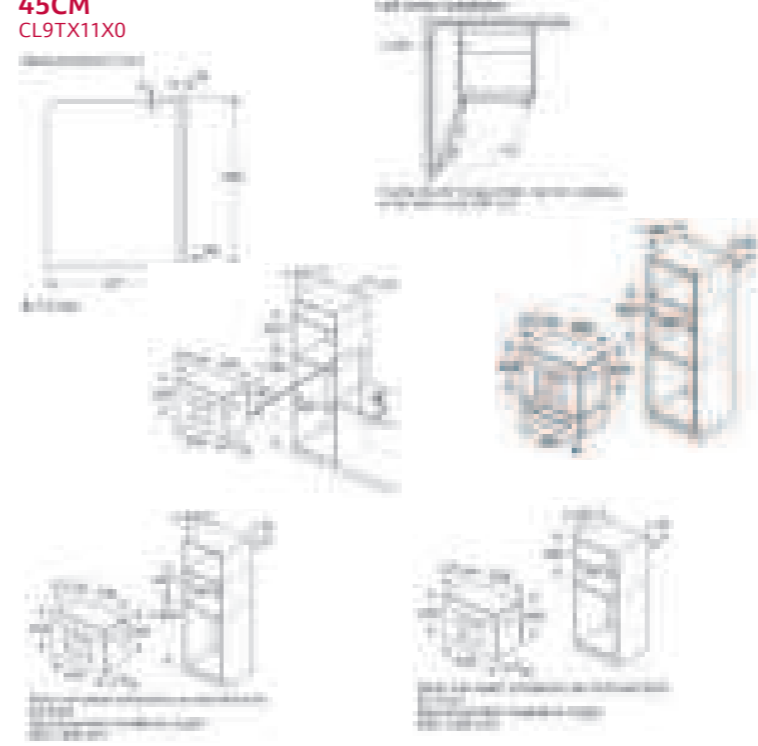

38CM
NL9WR21Y1B / NR9WR21Y1B

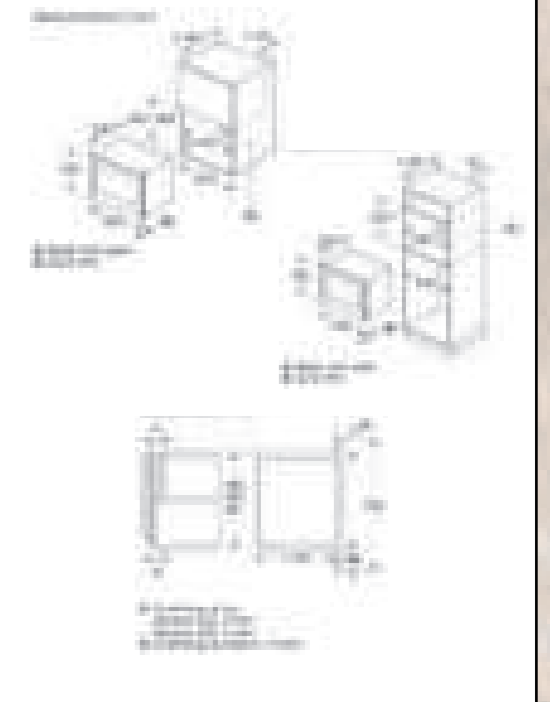

45CM
C29FS3AY0

Measurements in mm



Flex Design Appliances

Ovens & Compacts

FLEX DESIGN OVEN RANGE – N90 FULL TOUCH 3 - 6.8" FULL TOUCH TFT DISPLAY WITH FLEX CONTROL					
Collection	Display Size	Flex Design Oven description	No of Functions	Steam	Model Code
N90	Full Touch 3	Slide and Hide® Single Pyrolytic Oven with Vario Steam®	20	Vario Steam®	B69VY7MY0
N90	Full Touch 3	Slide and Hide® Single Pyrolytic Oven	14		B69CY7MY0
N90	Full Touch 3	Slide and Hide® Single Oven with Intensive Steam	23	Intensive	B69FY5CX0
N90	Full Touch 3	Compact Oven with Intensive Steam	23	Intensive	C29FY5CX0
N90	Full Touch 3	Compact Oven with Microwave	20		C29MY7MY0
N90	Full Touch 3	Compact Coffee Machine - Left Hinged Door	11		CL9TX11X0

FLEX DESIGN OVEN RANGE – N90 FULL TOUCH 2 - 4.1" FULL TOUCH TFT DISPLAY					
Collection	Display Size	Flex Design Oven description	No of Functions	Steam	Model Code
N90	Full Touch 2	Slide and Hide® Single Pyrolytic Oven with Vario Steam®	21	Vario Steam®	B69VS7MY0A
N90	Full Touch 2	Slide and Hide® Single Pyrolytic Oven	14		B69CS7MY0B
N90	Full Touch 2	Slide and Hide® Single Oven with Intensive Steam	24	Intensive	B69FS5CY0A
N90	Full Touch 2	Compact Oven with Intensive Steam	23	Intensive	C29FS3AY0
N90	Full Touch 2	Compact Oven with Microwave	20		C29MS7KY0

FLEX DESIGN OVEN RANGE – N70 FULL TOUCH 1 - 3.7" FULL TOUCH TFT DISPLAY					
Collection	Display Size	Flex Design Oven description	No of Functions	Steam	Model Code
N70	Full Touch 1	Slide and Hide® Single Pyrolytic Oven	14		B59CR7KY0B
N70	Full Touch 1	Compact Oven with Microwave	16		C29MR21Y0B
N70	Full Touch 1	38cm Microwave Oven - Left Hinged Door			NL9WR21Y1B
N70	Full Touch 1	38cm Microwave Oven - Right Hinged Door			NR9WR21Y1B

N90/N70 FLEX DESIGN DRAWER RANGE		
Collection	Flex Design Drawer Range	Model Code
N90/70	14cm Warming Drawer	N29HA11Y1B
N90/70	29cm Warming Drawer	N39HA11Y1B
N90/70	14cm Warming Drawer for Seamless Combination with Coffee Centre only	N29HA11Y2

Colour Coordinated Flex Design Side Trims and Handles

FLEX DESIGN TRIMS FOR SINGLE APPLIANCE - OVENS, COFFEE MACHINE AND DRAWERS					
When installing an individual appliance and not combining seamlessly then order from these model codes.					
Pack Contents	Length of Trim	Anthracite Grey	Brushed Bronze	Deep Black	Metallic Silver
2 x Side Trims and 1 x Handle for use with 60cm NEFF Collection Single ovens	60cm	Z9060AY0	Z9060BY0	Z9060DY0	Z9060MY0
2 x Side Trims and 1 x Handle for use with 45cm NEFF Collection Compact Ovens	45cm	Z9045AY0	Z9045BY0	Z9045DY0	Z9045MY0
2 x Side Trims for use with 45cm NEFF Collection Coffee Machine	45cm	ZC045AY0	ZC045BY0	ZC045DY0	ZC045MY0
2 x Side Trims for 38cm Microwaves	38cm	Z9038AY0	Z9038BY0	Z9038DY0	Z9038MY0
2 x Side Trims for use with 14cm NEFF Collection Drawers	14cm	Z9014AY0	Z9014BY0	Z9014DY0	Z9014MY0
2 x Side Trims for use with 29cm NEFF Collection Drawer	29cm	Z9029AY0	Z9029BY0	Z9029DY0	Z9029MY0

Optional Accessory					
Colour coordinated Twist Pad Flex® - Optional Accessory for ovens in the Full Touch 3 - 6.8" TFT screen size only	Twist Pad Flex®	Z9801TWAY0	Z9801TWBY0	Z9801TWDY0	Z9801TWMY0

FLEX DESIGN TRIMS FOR SEAMLESS COMBINATION INSTALLATION - OVENS, COFFEE MACHINE AND DRAWERS					
If ordering to install seamlessly you need to order from these model codes.					
Pack Contents	Length of Trim	Anthracite Grey	Brushed Bronze	Deep Black	Metallic Silver
2 x Side Trims and 1 x Handle for 60cm Seamless Combination Installations	60cm	Z9060AY0	Z9060BY0	Z9060DY0	Z9060MY0
2 x Side Trims to Install for the 60cm Seamless Combination of the Coffee machine and 14cm drawer - Coffee accessory also required	60cm	ZC060AY0	ZC060BY0	ZC060DY0	ZC060MY0
2 x Side Trims and 1 x Handle for 75cm Seamless Combination Installations	75cm	Z9075AY0	Z9075BY0	Z9075DY0	Z9075MY0
2 x Side Trims and 1 x Handle for 88cm Seamless Combination Installations	88cm	Z990AAY0	Z990ABY0	Z990ADY0	Z990AMY0
2 x Side Trims and 2 x Handles for 90cm Seamless Combination Installations	90cm	Z990BAY0	Z990BBY0	Z990BDY0	Z990BMY0
2 x Side Trims and 1 x Handle for use with 98cm Seamless Combination Installations	98cm	Z9098AY0	Z9098BY0	Z9098DY0	Z9098MY0
2 x Side Trims and 2 x Handles for 105cm Seamless Combination Installations	105cm	Z9105AY0	Z9105BY0	Z9105DY0	Z9105MY0
2 x Side Trims and 2 x Handles for use with 120cm Seamless Combination - Full Installation Details in guide. 120A Installation Combinations	120cm	Z912AAY0	Z912ABY0	Z912ADY0	Z912AMY0
2 x Side Trims and 2 x Handles for use with 120cm Seamless Combination - Full Installation Details in guide. 120B Installation Combinations	120cm	Z912BAY0	Z912BBY0	Z912BDY0	Z912BMY0

REQUIRED ACCESSORIES FOR SPECIFIC INSTALLATIONS - COFFEE MACHINE AND OVENS	
Pack Contents	Model Number
Coffee Accessory	ZC060TY0
Intermediate Platform - Required when installing an oven on top of an oven	Z166CAX0

Optional Accessory				
Colour coordinated Twist Pad Flex® - Optional Accessory for ovens in the Full Touch 3 - 6.8" TFT screen size only	Z9801TWAY0	Z9801TWBY0	Z9801TWDY0	Z9801TWMY0

OPTIONAL ACCESSORIES FOR SPECIFIC INSTALLATIONS - OVENS		
Shelves & Internal Racks	Model Number	Suitable For
Full width wire shelf	Z11CR10X0	N90 & N70 single & compact ovens
1 pair of level independent telescopic shelf rails with stop, fully extendable, for non-pyrolytic, non-full steam	Z1608BX0	N70 & N90 ovens
1 pair of level independent telescopic shelf rails with stop, fully extendable	Z1608CX0	N70 & N90 Pyrolytic ovens
1 pair of level independent telescopic shelf rails with stop, fully extendable	Z1608DX0	N90 Steam ovens
2 piece, half depth enamel pan set	Z1650BE0	N90 Steam ovens

Air Fryer Accessory - Air Fry Function Available As A NEFF Home Connect Download		
Pack Contents	Model Number	Required For
Air Fryer & Grill tray - Fitted as standard on most of the N90 & N70 Range	Z1655CA0	Required for Air Fry Function, for NEFF ovens with NEFF Home Connect

THE NEFF OVEN COLLECTIONS

HOBS

VENTILATION

REFRIGERATION

DISHWASHING

LAUNDRY

NEFF HOB

Range



The right hob for every cook, in every kitchen

Cooking and kitchen design are personal, which is why NEFF provides hobs to fit every preference, shape and size of kitchen.



Electric or gas? The choice is yours

Cooking and kitchen design are all about creativity and individual taste. NEFF has a range of hobs to suit any cooking style or kitchen design.

- **NEFF Electric Hobs**
 - Venting Hobs – available in 80cm, 70cm and 60cm sizes, Black Glass or Matt Black finishes.
 - Flex Induction Hobs – available in 90cm, 80cm and 60cm sizes, Black Glass or Matt Black finishes.
 - Induction Hobs – available in 80cm and 60cm sizes, all finished in black glass.
 - Ceramic Hobs – available 60cm size.
- **NEFF Gas Hobs** – available in 90cm, 75cm and 60cm sizes, Black Glass or Stainless Steel finishes.



Matt Black design is here!

Interior design trends are moving towards matt surfaces. This is also increasingly the case in the kitchen. Our approach at NEFF is to let you decide how your kitchen appliances fit into the overall picture. Whether you want them to take a backseat or centre stage. We truly follow the motto *"Your kitchen, your colour, your style!"*

Your kitchen, your colour, your style!

Available in new matt black glass, glossy black glass or stainless steel, NEFF hobs bring considered materials and clean lines to any kitchen. Choose the iconic TwistPad®, the Virtual TwistPad® with highly intuitive touch control, or precise gas cooking with Flame Select – the precision cook's favourite.

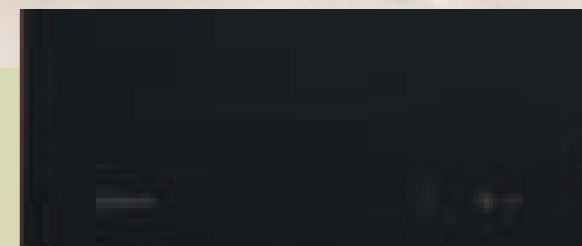

NEW Matt Black

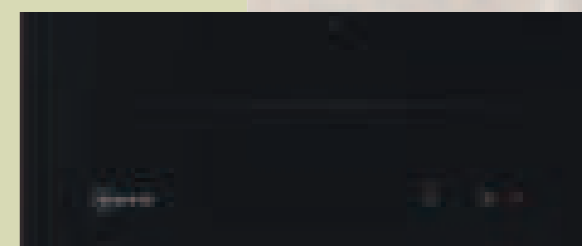

Black Glass

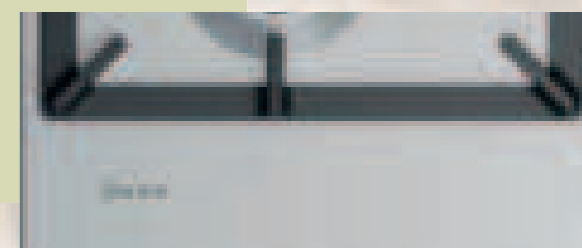

Stainless Steel

Open for individual style with Flex Design

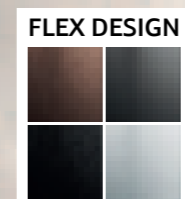

Create a harmonious kitchen with NEFF's Flex Design range allowing you to have a matching design theme across your cooking space. With four stunning finishes to choose from you can redesign your kitchen without replacing your appliances by just changing the finishing strips.

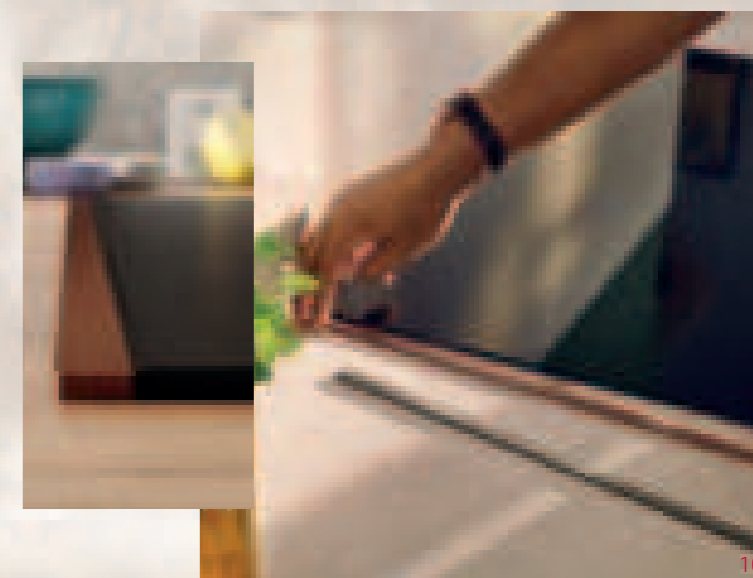

Your Guide To Hobs

Rethink cooking in NEFF's infinite kitchen

A great meal is all about the ingredients and cooking process. And it's the same when it comes to choosing the right hob. If you want flexibility, an electric Flex Induction hob might be what you're after. Or reclaim your space in the kitchen with our Venting Hob. With integrated ventilation you can install your hob on a kitchen island to create a sociable space when cooking. There's a NEFF hob for everyone to get creative with.



Induction Hobs

- If sleek, stylish and clean lines are more in keeping with your kitchen design, our Induction hobs provide a minimalistic and premium look whilst providing a quick and responsive cooking surface.
- Cooking with an Induction Hob saves energy and is incredibly safe – there is little residual heat once the saucepan is removed from the hob.

- **Available in 80cm and 60cm**
- **Available in Black Glass**



Featured model:
T56FHS1L0 N70 60cm Induction Hob Twist Touch® Control

Venting Hobs

- The 2-in-1 Hob and Hood is here. With freedom from a conventional wall or island hood, our integrated cooktop ventilation allows you to reclaim your space in the kitchen. The NEFF Venting Hob is set to create the stylish and sociable kitchen you've always dreamt of.
- Our Venting Hobs offer maximum flexibility in installation options - Unducted, Partly Ducted, Fully Ducted & Ducted out.

- **Available in 80cm, 70cm and 60cm**
- **Available in 2 surface finishes - Black Glass and Matt Black**
- **Available in Core and 4 Flex Design finishes**



Featured model:
V68YYX4B0 N90 80cm Venting Hob with Twist Touch® Control

Ceramic Hobs

- With their frameless design, our Ceramic hobs stand out in any kitchen, and a whole range of options with up to 17 power settings makes preparing the next feast as easy as pie.
- Better still, our enhanced touch control panel provides full flexibility over your cooking.

- **Available in 60cm**
- **Available in Black Glass**

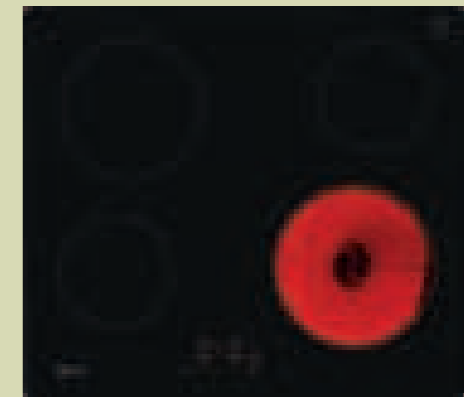

Featured model:
T16NBE1L N50 60cm Ceramic Hob

Flex Induction Hobs

- For sociable cooks who often find themselves juggling multiple pans, a Flex Induction hob provides any size pan, anywhere cooking within the zones.
- When the zones are activated, pans will receive instant, even and rapid heat transference wherever they are placed. Our range of Flex Induction hobs are available with a number of controls either with Twist Touch® control or using a NEFF Anthracite Grey Twist Pad®.

- **Available in 90cm, 80cm and 60cm**
- **Available in 2 surface finishes - Black Glass and Matt Black**
- **Available in Core and 4 Flex Design finishes**

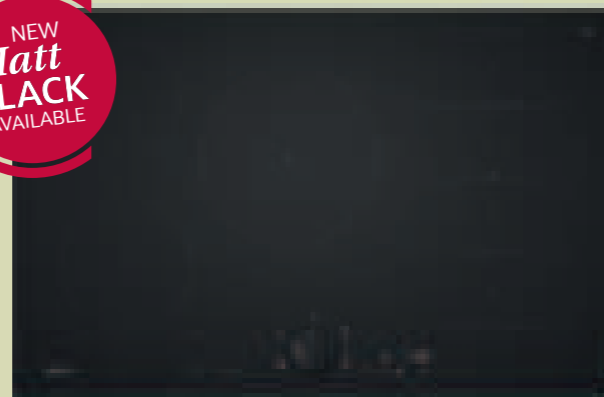

Featured model:
T68NUV4A0 N90 80cm Flex induction hob with Anthracite Grey Twist Pad®

Gas Hobs

- For traditionalists who prefer to see exactly how much heat is delivered to their pans, gas cooking provides a robust and reliable way to prepare your favourite dishes.
- You can control your hob by numbers and not by eye with our precise and responsive Flame Select® heat control feature, available across selected gas hobs.

- **Available in 90cm, 75cm and 60cm**
- **Available in 2 surface finishes - Black Tempered Glass & Stainless Steel**



Featured model:
T27PIQ450 N70 75cm Gas Hob



The all new MATT BLACK DESIGN

What speaks in FAVOUR OF MATT BLACK?

Design choice

A deep, true black with an understated presence that blends seamlessly into your kitchen. The user interface remains bright and crisp for effortless control.

Easy to clean

Fingerprints and smudges are far less visible than on glossy finishes, and wiping leaves no streaks – cleaning is quicker and simpler.

Less visible scratches

The matt surface masks light wear and scratches, preserving a pure, long-lasting look.



Less
finger-
prints



Less visible
scratches*

Easy
to clean.
Bye bye
streaks!

Practical performance PURIST DESIGN

Interior design trends are moving towards matt surfaces. This is also increasingly the case in the kitchen. Our approach at NEFF is to let you decide how your kitchen appliances fit into the overall picture. Whether you want them to take a backseat or centre stage. We truly follow the motto

“Your kitchen, your colour, your style!”





Glass Draft Hoods Flex Design

Seamless Hob Installation

Celebrate your kitchen design with visual unity. Our Glass Draft Hood has been designed to be installed seamlessly with any of our Flex Design hobs in the corresponding 90cm or 80cm width.

Ordering Flex Design

The process is defined within the brochure. For all Flex Design hobs the trim size is the same.

If combining the Flex Design hob with a Flex Design Glass Draft hood, please follow the detailed instructions on pages 122-123.

Open for fresh designs

The Flex Design hobs in this range can be customised with a choice of four side trims and coordinating Twist Pad Flex®. Simply choose the trim colour at the time of ordering.

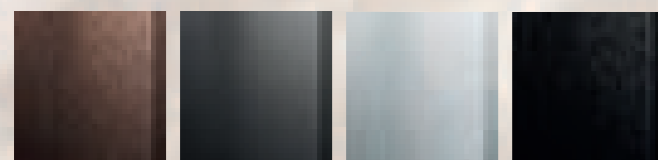
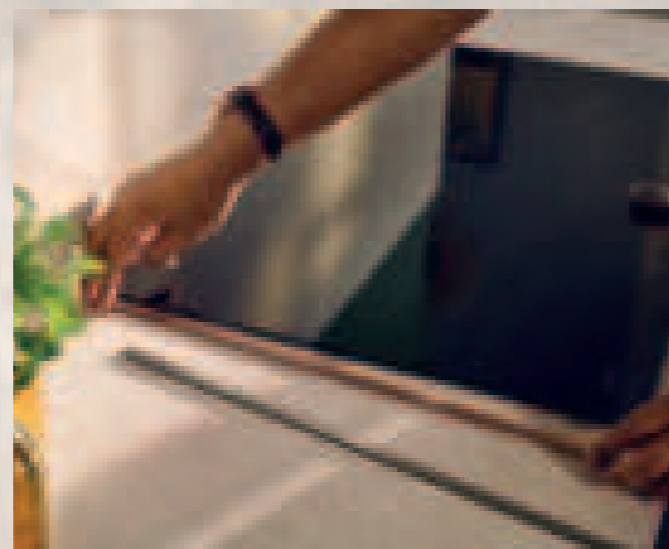

Brushed Bronze Anthracite Grey Metallic Silver Deep Black



Guide To Electric Hobs

Venting Hobs

AVAILABLE IN 80CM, 70CM AND 60CM SIZES.



Featured model:
V58PHQ4C0 N70 80cm Venting Hob with Twist Touch® Control

Flex Induction Hobs

AVAILABLE IN 90CM, 80CM AND 60CM SIZES.

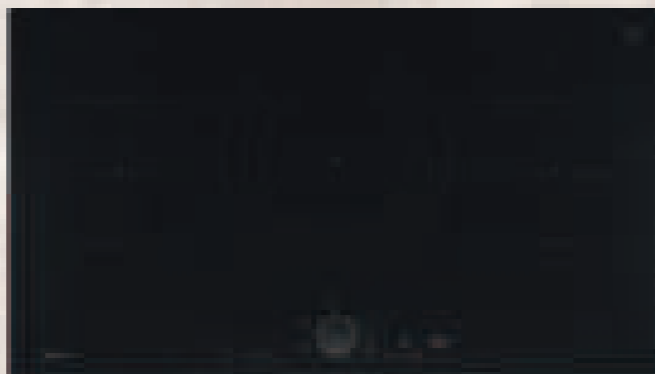

Featured model:
T69FUV4L0 N90 90cm Flex induction hob with Anthracite Grey Twist Pad®

Induction Hobs

AVAILABLE IN 80CM AND 60CM SIZES.

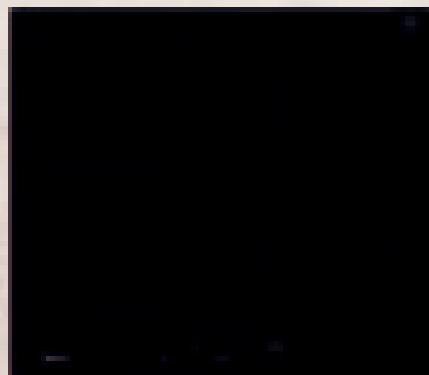

Featured model:
T56FHS1L0 N70 60cm Induction Hob Twist Touch® Control

Ceramic Hobs

AVAILABLE IN 60CM.

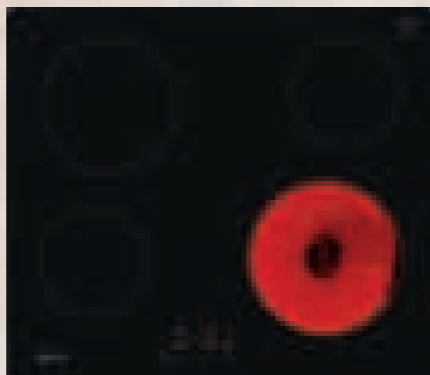

Featured model:
T16NBE1L N50 60cm Ceramic Hob

Ceramic & Induction Hobs Finishes

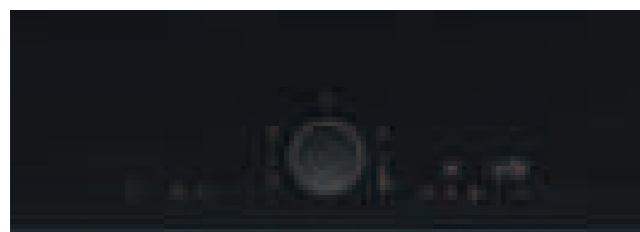

Frameless with front bevel

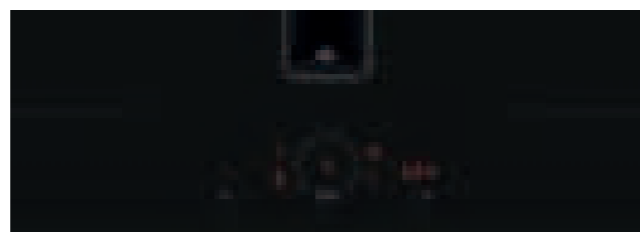

Flushline

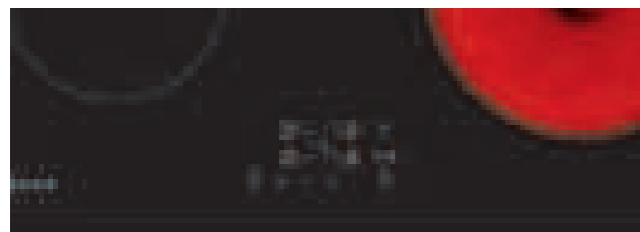

Frameless

General Features

COMBI INDUCTION

2 individual induction cooking zones can be combined to 1 large zone with even heat distribution.

COMBI ZONE

The Combi Zone allows you to combine two adjacent cooking zones into a single, larger zone. This flexibility enables the use of larger cookware or multiple pots and pans simultaneously, accommodating various cooking needs.

EXTENDED FRYING SENSOR

The sensor automatically adjusts the heat to the pan to maintain an even temperature. This control allows you to cook all dishes to perfection as it maintains a consistent heat preventing overcooking or burning.

TOUCH CONTROL

Simply select a zone then swipe your finger across the control panel to select a heat mode.

POWER BOOST

More heat when you need it. Power Boost is our smart, time-saving cooking hack. Want to boil your pasta water in a flash? Simply activate Power Boost to heat it much faster. Get a flexible boost for your dishes.

POWER TRANSFER

Move your pots, not your focus. Power Transfer recognizes the heat level and size of your pot, automatically transferring these settings to the new location when you move it. No more pushing and adjusting, a gentle tap is enough to confirm, keeping your focus on the essence of cooking – your intuition.

TWIST TOUCH®

Direct interaction with a twist of your finger. Twist Touch® control lets you select everything with the tip of your finger. Choose your desired cooking zone or select your preferred power level – cooking the easy way.

POWER MOVE

With Power Move, you have the flexibility to move pots and pans between two or three heating zones to accommodate various cooking needs.

ANTHRACITE GREY TWIST PAD®

The Anthracite Grey Twist Pad® allows you to precisely adjust the heating degree of pots, frying pans and grills with just one finger touch. Simply touch the Anthracite Grey Twist Pad® lightly to activate the desired cooking zone, then rotate to select the desired power level. The magnetic Anthracite Grey Twist Pad® is removable and ready to transform your hob into a creative and easy-to-clean hotspot!

FLEX INDUCTION

Flex Induction allows for flexibility with cooking by having larger cooking zones which automatically detect the size of the pans. This means you can use larger cookware like griddle plates or large casserole dishes with even heat distribution.

NEFF Home Connect Features

NEFF HOME CONNECT

Control your hob easily from your smartphone or voice assistant when connected with the NEFF Home Connect app.

FAVOURITE BUTTON

Personalise your hob according to your preferences: using NEFF Home Connect you can add your favourite functions to your hob and operate them directly via the Favourite Button in the user interface. This allows you to switch the hood lights on or off with ease from your hob or combine different settings to easily cook your everyday dishes at a glance.

HOB-HOOD CONTROL

Our Hob-Hood Control is a convenient feature that creates real cooking comfort. When you start your hob, your hood will turn on automatically. To do so, simply pair your hob and hood with the NEFF Home Connect app.

Safety Features

RESIDUAL HEAT INDICATOR

The moment you turn off your hob, the display offers a clever safety function, indicating which cooking zones are still hot or warm.

CONTROL PANEL LOCK

Prevents unintended activation of the hob.

SAFETY TIME SWITCH OFF

For safety reasons, heating stops after a preset time if not used. It is possible to customise this feature.

PAUSE

The Pause function allows you to easily pause the heating and block all buttons on your hob, giving you the flexibility to attend to other tasks while cooking. You can pause and then continue cooking within the next 10 minutes.

Style, Control, Choice – NEFF Electric Hobs Range at a glance

Choosing the right Electric Hob for you









NEFF offers intuitive controls and precise heating to suit every cook and kitchen layout.



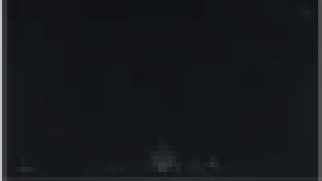
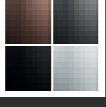





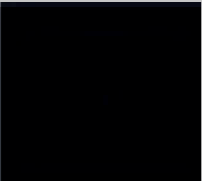













For complete personalisation

Personalise your hob and hood with easily interchangeable Flex Design Trim, available in four distinctive colours, to coordinate with the design of your kitchen.



HOB TYPE	DESIGN TYPE	VALUE CLASS	FINISH	90CM
 <p>NEFF VENTING HOBS With four recirculation or ducted out installation options, Unducted Recirculation is the easiest and quickest to fit.</p>	 <p>FLEX DESIGN</p>	N90	Black Glass	
			Matt Black 	
		N70	Black Glass	
	<p>Core Range</p>	N90	Black Glass	
		N70	Black Glass	
	N50	Black Glass		
 <p>FLEX INDUCTION HOBS Versatile and precise cooking with flexible placement of cookware on a single cooking zone.</p>	 <p>FLEX DESIGN</p>	N90	Black Glass	T69YYX4C0  3 x Flex Zones
		N70	Black Glass	T69YYV4C0  2 x Flex Zones + 32cm triple zone
	<p>Core Range</p>	N90	Black Glass	T69FUV4L0  Twist Pad, 2 Flex Zones, Extended Frying Sensor, Bevel Front
			Matt Black 	
		N70	Black Glass	T69FHV4L0  Twist Touch, 2 Flex Zones, Extended Frying Sensor, Bevel Front
 <p>INDUCTION HOBS Fast, efficient, and precise cooking with instant heat and precise temperature control.</p>	<p>Core Range</p>	N70	Black Glass	
		N30	Black Glass	
<p>CERAMIC HOBS Sleek and easy-to-clean cooking surfaces with responsive heat for effortless cooking.</p>	<p>Core Range</p>	N50	Black Glass	

80CM	70CM	60CM	
V68YYX4C0  Venting hob, 2 Flex Zones, Extended Frying Sensor			
V68YYX4B0  Venting hob, 2 Flex Zones, Extended Frying Sensor			
V58YHQ4C0  Venting hob, Extended Frying Sensor, 2x combiZones	V57YHQ4C0  Venting hob, Extended Frying Sensor, 2x combiZones		
V68FUX4L0  Venting hob, 2 Flex Zones, Extended Frying Sensor			
V58PHQ4C0  Twist Touch Control, Extended Frying Sensor, Frameless, Flushline Installation	V58NHQ4L0  Twist Touch Control, Extended Frying Sensor, Frameless	V57THQ4L0  Twist Touch, Stainless Steel Frame, Extended Frying Sensor	
V58NBS1L0 Touch Control, Frameless		V56NBS1L0 Touch Control, Frameless	
T68YYY4C0  2 x Flex Zones + 32cm triple zone	T68YYY4C0  2 x Extended Flex		
		T66YYY4C0  2 x Extended Flex	
T68FUV4L0  Twist Pad, 1 x Flex Zone, Extended Frying Sensor, Smart Hood Automatic			
T68NUV4A0  Twist Pad, 1 x Flex Zone, Extended Frying Sensor, Smart Hood Automatic		T66NUX4A0  Twist Pad, 2 x Flex Zones, Extended Frying Sensor, Smart Hood Automatic	
T68FHV4L0  Twist Pad, 2 x Flex Zone, Extended Frying Sensor, Bevel Front		T66FHX4L0  Twist Touch, 2 x Flex Zones, Extended Frying Sensor, Bevel Front	T66FHE4L0  Twist Touch, 1 x Flex Zone, Extended Frying Sensor, Bevel Front
T58FHW1L0  Twist Touch, 5 Combi Zones, Bevel Front	T58PHW1L0  Twist Touch, 5 Combi Zones, Flushline	T56FHS1L0  Twist Touch, 4 Combi Zones, Bevel Front	
		T36FBE1L0 Touch Control, 4 Zones, Bevel Front	T36FBE1L0G Touch Control, 4 Zones, Plug & Play with GB Plug, Bevel Front
			T36CA50X1U Touch Control, 4 Zones, 1 Boost Zone, Plug & Play with GB Plug, Frameless
		T16NBE1L Touch Control, 4 Zones, Frameless	

ELECTRIC HOBS

THE NEFF OVEN COLLECTIONS

HOBS

VENTILATION

REFRIGERATION

DISHWASHING

LAUNDRY

Your Guide To Single Appliance Flex Design



Flex Induction Hobs

Flex Design pack includes Side Trims for Induction Hobs. The Twist Pad Flex® is required and has to be ordered separately.

STEP 1 CHOOSE YOUR FLEX INDUCTION HOB				STEP 2 CHOOSE YOUR FLEX DESIGN TRIM		STEP 3 CHOOSE YOUR TWIST PAD FLEX®		STEP 4 COMPLETED APPLIANCE
Collection	Size	Hob Type	Model Number	Finish	Model Number	Finish	Model Number	
N90	90cm	3 Flex zones, frying sensor.	T69YYX4C0	Anthracite Grey	Z9802PFAY0	Anthracite Grey	Z9801TWAY0	 <p>Model shown: T69YYV4C0 Flex Induction Hob Z9802PFBY0 Flex Design Trim Z9801TWBY0 Twist Pad Flex®</p>
N90	90cm	2 Flex zones, 32cm triple zone, frying sensor.	T69YYV4C0	Brushed Bronze	Z9802PFBY0	Brushed Bronze	Z9801TWBY0	
N90	80cm	2 extended flex, frying sensor.	T68YYY4C0	Deep Black	Z9802PFDY0	Deep Black	Z9801TWDY0	
N90	60cm	2 extended flex, frying sensor.	T66YYY4C0	Metallic Silver	Z9802PFMY0	Metallic Silver	Z9801TWMY0	





Your Guide To Seamless Combination Flex Design

Side Trim – Induction Hob and Glass Draft Hood

Induction Hob installed with Glass Draft Hood with Seamless Combination trim.

STEP 1 CHOOSE YOUR COMPLETED COMBINATION

GLASS DRAFT HOOD
90cm HOB

STEP 2 SUITABLE APPLIANCES

CHOOSE YOUR INDUCTION HOB*			
Collection	Size	Hob Type	Model Number
N90	90cm	3 Flex zones, frying sensor.	T69YYX4C0
N90	90cm	2 Flex zones, 32cm triple zone, frying sensor.	T69YYV4C0
N90	80cm	2 extended flex, frying sensor.	T68YYY4C0

CHOOSE YOUR GLASS DRAFT HOOD*			
Collection	Size	Hood Type	Model Number
N90	90cm	Guided Air technology, Automatic Air Sensor, Clear Glass with Ambient Light	I98WMM1Y7B
N90	80cm	Guided Air technology, Automatic Air Sensor, Clear Glass with Ambient Light	I88WMM1Y7B

*Please note you can combine 90cm Hob and Hood or 80cm hob and hood.

STEP 3 CHOOSE YOUR FLEX DESIGN TRIM

CHOOSE YOUR FLEX DESIGN TRIM	
Finish	Model Number
Anthracite Grey	Z9302GLAY0
Brushed Bronze	Z9302GLBY0
Deep Black	Z9302GLDY0
Metallic Silver	Z9302GLMY0

PLUS REQUIRED INSTALLATION ACCESSORY SITS BENEATH APERTURE TO SUPPORT HOB AND HOOD PRODUCTS

90cm Installation Accessory	Z92WWY9X2
80cm Installation Accessory	Z92WWY8X2

STEP 4 CHOOSE YOUR TWIST PAD FLEX®

CHOOSE YOUR FINISH	
Finish	Model Number
Anthracite Grey	Z9801TWAY0
Brushed Bronze	Z9801TWBY0
Deep Black	Z9801TWDY0
Metallic Silver	Z9801TWMY0

SUMMARY ORDER... TO ACHIEVE THIS INSTALLATION ORDER THE FOLLOWING SUITE OF MODEL CODES

To install a 90cm Induction Hob and 90cm Glass Draft Hood in Brushed Bronze.

- T69YYX4C0** Induction Hob
- I98WMM1Y7B** Glass Draft Hood
- Z9302GLBY0** Flex Design Trim
- Z92WWY9X2** Required Installation Accessory
- Z9801TWBY0** Twist Pad Flex®

Flex Design Venting Hobs



All Flex Design have a 5 year warranty

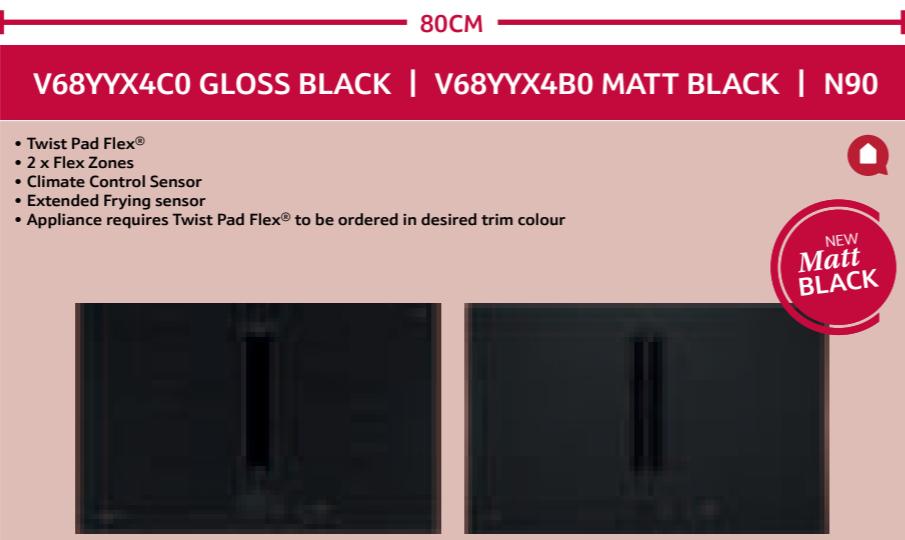

- Twist Pad Flex®
- 2 x Flex Zones
- Climate Control Sensor
- Extended Frying sensor
- Appliance requires Twist Pad Flex® to be ordered in desired trim colour

KEY FEATURES	
Twist Pad Flex® required	•
Integrated extractor	•
Frying Sensor	11 levels
Favourite Button	•
Automatic extraction	Fully sensor based
Number of Flex Induction zones	2
Number of Combi Zone	
HOB FEATURES	
Number of individual zones	4
Power Levels	17
Power Boost	•
Power Transfer	•
Digital display / Adaptable Volume	• / •
Count up Timer / Count down timer / Pause Function	/ • / •
Main on/off switch / Quick Start / Quick Stop/ Restart Function	• / • / •
Pan Recognition / Pan Boost	• / Via HC/Favourite Button
Dish Categories / Setting Recommendations	Via HC
Keep Warm Function	Via HC/Favourite Button
SAFETY FEATURES	
Residual Heat Indicator	•
Control Panel Lock / Safety Time Switch off	• / •
HOOD FEATURES	
Climate Control sensor	•
Power levels	17 + 2 Intensive
Automatic intensive revert setting	6 minutes
Automatic or manual control / Interval operation	• / •
Automatic after running (extraction/recirculation)	12 / 30 minutes
Dishwasher safe grease filter cassette with spillage collection	Yes - 200ml capacity
Dishwasher safe spillage overflow collector	700ml capacity
Metal grease filter / Electronic grease filter / Clean Air filter saturation indicators	• / • / •
PERFORMANCE / TECHNICAL INFORMATION – HOB	
Nominal voltage / Maximum power output	V / W 220-240 / 7,400
Electrical cable length	cm 110
Rear left Induction zone	kW/mm 2.20 200x230
Rear right Induction zone	kW/mm 2.20 200x230
Front left Induction zone	kW/mm 2.20 200x230
Front right Induction zone	kW/mm 2.20 200x230
Flex Induction / Combi Zone zone left	kW/mm 3.30 400x230
Flex Induction / Combi Zone zone right	kW/mm 3.30 400x230
Combi Zone left	kW/mm
Combi Zone right	kW/mm
Rear left / right zone – with Power Boost	max. kW 3.70 / 3.70
Front left / right zone – with Power Boost	max. kW 3.70 / 3.70
PERFORMANCE / TECHNICAL INFORMATION – EXTRACTOR	
Extractor energy efficiency rating	A B
Extraction Rate in m³/h¹²	
Ducted / Recirculating power level Minimum	154 / 132
Ducted / Recirculating power level Maximum	500 / 499
Ducted / Recirculating power level Intensive	622 / 595
Noise level (sound power) based on dB(A) re 1 pW¹³	
Ducted / Recirculating power level Minimum	42 / 41
Ducted / Recirculating power level Maximum	69 / 68
Ducted / Recirculating power level Intensive	74 / 72
Motor power	170



- Twist Touch® Control
- 2 x Combi Zone
- Auto-On Fan
- Extended Frying Sensor

	•
	11 levels
	•
	Auto-On
	2: Left & Right
	4
	17
	•
	• / •
	/ • / •
	• / • / •
	• / Via HC/Favourite Button
	Via HC/Favourite Button
	•
	• / •
	9 + 2 Intensive
	6 minutes
	• / •
	30 minutes
	Yes - 200ml capacity
	700ml capacity
	• / • / •
	220-240 / 7,400
	110
	2.50 190x210
	2.50 190x210
	2.50 190x210
	2.50 190x210
	3.60 380x210
	3.60 380x210
	3.70 / 3.70
	3.70 / 3.70
	A B
	154 / 117
	500 / 487
	622 / 595
	42 / 41
	69 / 68
	74 / 72
	170

Flex Design Trim

All Flex Design Venting Hobs require a set of Flex Design side trims to be ordered. All trims are a standard size and available in all 4 colours.

Finish	Model Number
Anthracite Grey	Z90802PFAY0
Brushed Bronze	Z90802PFBY0
Deep Black	Z90802PFDY0
Metallic Silver	Z90802PFMY0

Twist Pad Flex®

To complete the Hob the choice of Twist Pad Flex® also needs to be ordered. Choose a side trim and Twist Pad Flex® in the desired colour.





Finish	Model Number
Anthracite Grey	Z9801TWAY0
Brushed Bronze	Z9801TWBY0
Deep Black	Z9801TWDY0
Metallic Silver	Z9801TWMY0

¹ Air flow and noise declarations made in line with CECEC Code Of Conduct. ²Measured according to EN61591 on largest pipe diameter. ³Sound power measured according to EN60704-3 on largest pipe diameter.

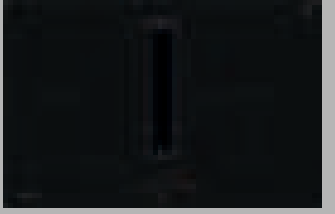
Venting Hobs

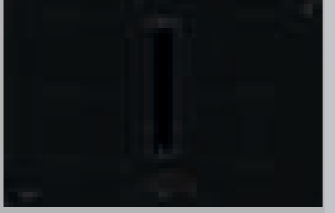
- Installed with energy efficient brushless motors that offer powerful but quiet performance.
- Can be installed in Recirculation or Ducted Out – 4 Ventilation solutions available.
- A larger Overflow container will hold up to 700ml and is integrated in the base of the appliance so will not impact on storage space below.
- To install in re-circulation mode no further components are required.

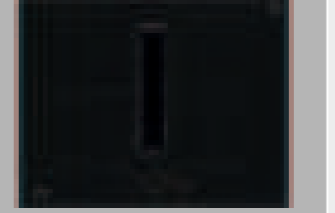
	80CM		80CM	
	V68FUX4L0 N90		V58PHQ4C0 N70	
	<ul style="list-style-type: none"> • Anthracite Grey Twist Pad® • 2 x Flex Zones • Climate Control • Extended Frying Sensor Pro 		<ul style="list-style-type: none"> • Twist Touch® Control • 2 x Combi Zones • Extended Frying Sensor Pro • Flushline Installation 	
KEY FEATURES				
NEFF Home Connect	●		●	
Integrated extractor	●		●	
Automatic extraction	Fully sensor based		Auto-On	
Favourite Button	●		●	
Extended Frying Sensor	11 settings		11 settings	
Power Move / Power Boost / Power Transfer	/ ● / ●		/ ● /	
Flex Induction	●		●	
Number of Flex Induction zones	2		2: Left & Right	
Combi Zone Induction				
HOB FEATURES				
Number of individual zones	4		4	
Power Levels	17		17	
Digital display / Adaptable Volume	● / ●		● / ●	
Count up Timer / Count down timer	/ ●		/ ●	
Main on/off switch / Quick Start / Restart Function / Quick Stop	● / ● / ● /		● / ● / ● /	
Energy Consumption Display	●		●	
Pan Recognition / Pan Boost	● /		● /	
Demo Mode	●		●	
Dish Categories / Setting Recommendations	Via HC		Via HC	
Keep Warm Function	Via HC / Favourite Button		Via HC / Favourite Button	
SAFETY FEATURES				
Residual Heat Indicator / Pause Function	● / ●		● / ●	
Timer with automatic switch off for each zone	● / ●		● / ●	
Control Panel Lock / Safety Time Switch off	● / ●		● / ●	
HOOD FEATURES				
Climate Control sensor	●		●	
Power levels	17 + 2 Intensive		9 + 2 Intensive	
Automatic intensive revert setting	6 minutes		6 minutes	
Automatic or manual control / Interval operation	● / ●		● / ●	
Automatic after running (extraction/recirculation)	12 / 30 minutes		30 minutes	
Dishwasher safe grease filter cassette with spillage collection	Yes - 200ml capacity		Yes - 200ml capacity	
Dishwasher safe spillage overflow collector	700ml capacity		700ml capacity	
Metal grease filter / Electronic grease filter / cleanAir filter saturation indicators	● / ● / ●		● / ● / ●	
PERFORMANCE / TECHNICAL INFORMATION – HOB				
Nominal voltage / Maximum power output	V / W 220-240 / 7,400		220-240 / 7,400	
Electrical cable length	cm 110		110	
Rear left Induction zone	kW/mm 2.20	200x240	2.50	190x210
Rear right Induction zone	kW/mm 2.20	200x240	2.50	190x210
Front left Induction zone	kW/mm 2.20	200x240	2.50	190x210
Front right Induction zone	kW/mm 2.20	200x240	2.50	190x210
Flex Induction zone left	kW/mm 3.30	400x240		
Flex Induction zone right	kW/mm 3.30	400x240		
CombiZone left	kW/mm		3.60	380x210
CombiZone right	kW/mm		3.60	380x210
Rear left / right zone – with Power Boost	max. kW 3.70 / 3.70		3.70 / 3.70	
Front left / right zone – with Power Boost	max. kW 3.70 / 3.70		3.70 / 3.70	
PERFORMANCE / TECHNICAL INFORMATION – EXTRACTOR				
Extractor energy efficiency rating	A B		A B	
Extraction Rate in m³/h¹²				
Ducted / Recirculating power level Minimum	154 / 132		154 / 117	
Ducted / Recirculating power level Maximum	500 / 499		500 / 487	
Ducted / Recirculating power level Intensive	622 / 595		622 / 595	
Noise level (sound power) based on dB(A) re 1 pW³				
Ducted / Recirculating power level Minimum	42 / 41		42 / 41	
Ducted / Recirculating power level Maximum	69 / 68		69 / 68	
Ducted / Recirculating power level Intensive	74 / 72		74 / 72	
Motor power	170		170	

	80CM		70CM		60CM			
	V58NHQ4L0 N70		V58NBS1L0 N50		V57THQ4L0 N70		V56NBS1L0 N50	
	<ul style="list-style-type: none"> • Twist Touch® Control • 2 x Combi Zones • Extended Frying Sensor Pro 		<ul style="list-style-type: none"> • Touch Control • 4 Zones / 1 Combi zone 		<ul style="list-style-type: none"> • Twist Touch® Control • 2 x Combi Zones • Extended Frying Sensor Pro • Stainless Steel Side Trims 		<ul style="list-style-type: none"> • Touch Control • 4 Zones / 1 Combi zone 	
KEY FEATURES								
NEFF Home Connect	●		●		●		●	
Integrated extractor	●		●		●		●	
Automatic extraction	Auto-On		Auto-On		Auto-On		Auto-On	
Favourite Button	●		●		●		●	
Extended Frying Sensor	11 settings		/ ● /		11 settings		/ ● /	
Power Move / Power Boost / Power Transfer	/ ● /		/ ● /		/ ● /		/ ● /	
Flex Induction	●		●		●		●	
Number of Flex Induction zones	2		1		2: Left & Right		1	
Combi Zone Induction	2: Left & Right		1		2: Left & Right		1	
HOB FEATURES								
Number of individual zones	4		4		4		4	
Power Levels	17		17		17		17	
Digital display / Adaptable Volume	● / ●		● / ●		● / ●		● / ●	
Count up Timer / Count down timer	/ ●		/ ●		/ ●		/ ●	
Main on/off switch / Quick Start / Restart Function / Quick Stop	● / ● / ● /		● / ● / ● /		● / ● / ● /		● / ● / ● /	
Energy Consumption Display	●		●		●		●	
Pan Recognition / Pan Boost	● /		● /		● /		● /	
Demo Mode	●		●		●		●	
Dish Categories / Setting Recommendations	Via HC		Via HC		Via HC		Via HC	
Keep Warm Function	Via HC / Favourite Button		Via HC / Favourite Button		Via HC / Favourite Button		Via HC / Favourite Button	
SAFETY FEATURES								
Residual Heat Indicator / Pause Function	● / ●		● / ●		● / ●		● / ●	
Timer with automatic switch off for each zone	● / ●		● / ●		● / ●		● / ●	
Control Panel Lock / Safety Time Switch off	● / ●		● / ●		● / ●		● / ●	
HOOD FEATURES								
Climate Control sensor	●		●		●		●	
Power levels	9 + 2 Intensive		3 + 1 Intensive		9 + 2 Intensive		3 + 1 Intensive	
Automatic intensive revert setting	6 minutes		6 minutes		6 minutes		6 minutes	
Automatic or manual control / Interval operation	● / ●		● / ●		● / ●		● / ●	
Automatic after running (extraction/recirculation)	30 minutes		12 / 30 minutes		30 minutes		12 / 30 minutes	
Dishwasher safe grease filter cassette with spillage collection	Yes - 200ml capacity		Yes - 200ml capacity		Yes - 200ml capacity		Yes - 200ml capacity	
Dishwasher safe spillage overflow collector	700ml capacity		700ml capacity		700ml capacity		700ml capacity	
Metal grease filter / Electronic grease filter / cleanAir filter saturation indicators	● / ● / ●		● / ● / ●		● / ● / ●		● / ● / ●	
PERFORMANCE / TECHNICAL INFORMATION – HOB								
Nominal voltage / Maximum power output	V / W 220-240 / 7,400		220-240 / 7,400		220-240 / 7,400		220-240 / 7,400	
Electrical cable length	cm 110		110		110		110	
Rear left Induction zone	kW/mm 2.50	190x210	2.20	190x210	2.50	190x210	2.20	190x210
Rear right Induction zone	kW/mm 2.50	190x210	1.80	180	2.50	190x210	1.40	145
Front left Induction zone	kW/mm 2.50	190x210	2.20	190x210	2.50	190x210	2.20	190x210
Front right Induction zone	kW/mm 2.50	190x210	2.20	210	2.50	190x210	2.20	210
Flex Induction zone left	kW/mm 3.60	380x210			3.60	380x210		
Flex Induction zone right	kW/mm 3.60	380x210			3.60	380x210		
CombiZone left	kW/mm 3.60	380x210	3.60	380x210	3.60	380x210	3.60	380x210
CombiZone right	kW/mm 3.60	380x210	3.60	380x210	3.60	380x210	3.60	380x210
Rear left / right zone – with Power Boost	max. kW 3.70 / 3.70		3.70 / 3.10		3.70 / 3.70		3.70 / 2.20	
Front left / right zone – with Power Boost	max. kW 3.70 / 3.70		3.70 / 3.70		3.70 / 3.70		3.70 / 3.70	
PERFORMANCE / TECHNICAL INFORMATION – EXTRACTOR								
Extractor energy efficiency rating	A B		A B		A B		A B	
Extraction Rate in m³/h¹²								
Ducted / Recirculating power level Minimum	154 / 117		330 / 252		154 / 117		330 / 252	
Ducted / Recirculating power level Maximum	500 / 487		500 / 441		500 / 487		500 / 441	
Ducted / Recirculating power level Intensive	622 / 595		622 / 595		622 / 595		622 / 595	
Noise level (sound power) based on dB(A) re 1 pW³								
Ducted / Recirculating power level Minimum	42 / 41		61 / 55		42 / 41		61 / 55	
Ducted / Recirculating power level Maximum	69 / 68		69 / 66		69 / 68		69 / 66	
Ducted / Recirculating power level Intensive	74 / 72		74 / 72		74 / 72		74 / 72	
Motor power	170		170		170		170	

¹ Air flow and noise declarations made in line with CECEC Code Of Conduct. ² Measured according to EN61591 on largest pipe diameter. ³ Sound power measured according to EN60704-3 on largest pipe diameter.

Venting Hob Installation Options

For the full range of installation accessories see page 132 of the Appliance Line Drawings.

UNDUCTED RECIRCULATION

Why use Unducted Recirculation

- Easy and quick to fit
- Less parts
- Cost effective

Requires no reduction in depth to the bottom two drawers and allows for more design flexibility, for example, floating islands.

Automatic run on of the extractor fan at min power level dries the filters and continues air flow through the service void, removing any potential moisture for extra safety.



Full Depth Drawers Possible

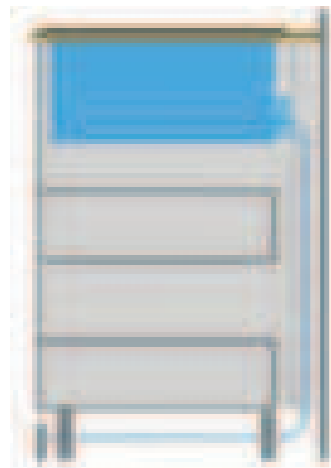

Installation considerations

What do I need?

- 4 x cleanAir filters and telescopic slider.
- These are supplied as standard with all inductionAir Plus appliances.

Good to know

- Telescopic slider ventilates air from the appliance into the service void. Max expansion of slider 80mm.
- Min requirement of service void 25mm, recommended 50mm min.

Important to note

- This option is NOT suitable for installations with non insulated walls.
- This is the ONLY installation type that uses the telescopic slider.

PARTLY DUCTED RECIRCULATION

Why use Partly Ducted Recirculation

Required when the distance from the back of the appliance to back of the base unit void is greater than 80mm.

Suitable for installations with non insulated walls or where damp has been an issue.



Maximum drawer depth 513mm with 70+cm worktop

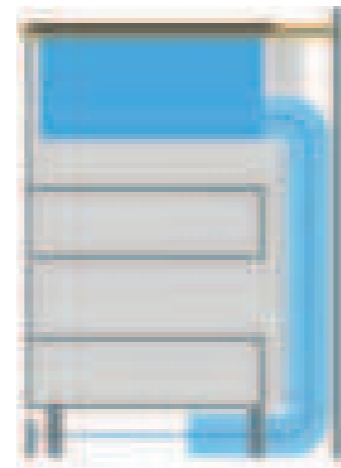

Installation considerations

What do I need?

- 4 x cleanAir re-circulating filters. Supplied with appliance.
- Starter Kit 1 **Z861KR0** or 2 **Z861KR1** depending on the work surface depth.

Good to know

- Partly Ducted Recirculation takes the air down into the plinth and ventilates in through the plinth cavity.
- This requires greater depth work surface or reduced depth drawers.
- The 94mm ducting height cannot be changed to a slimmer version (reduces effectiveness) using an adaptor, as the 94mm space is still needed for the 90 degree turn from the horizontal to the vertical.

Important to note

- Starter Kits 1 and 2 provide all the required ducting and connectors for this mode of installation.
- The appliance may be fitted with another manufacturers ducting that has a rounded radius (please check compatibility before purchase). You will still need to purchase a **(Z821PD1)** diffuser.

FULLY DUCTED RECIRCULATION

Why use Fully Ducted Recirculation

Required when the distance from the back of the appliance to back of the base unit void is greater than 80mm.

Gives total peace of mind for non insulated walls or where damp has been an issue.



Maximum Drawer Depth 513mm with 70+cm worktop

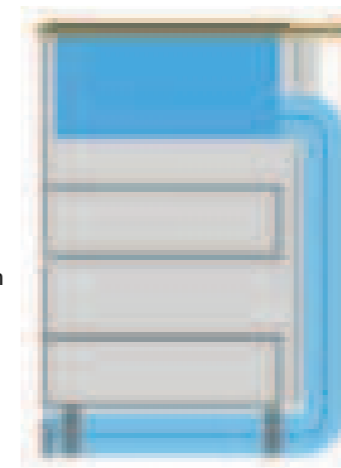

Installation considerations

What do I need?

- 4 x cleanAir re-circulating filters. Supplied with appliance.
- Starter Kit 1 **Z861KR0** or 2 **Z861KR1** depending on the work surface depth
- To fully duct to the plinth an additional straight channel and a connector are required. A 500mm ducting section should be sufficient in most cases depending on worktop depth.

Good to know

- Full Recirculation kit takes air down through the plinth and out into the room via a plinth vent.
- This requires greater depth or reduced depth drawers.
- The 94mm ducting height cannot be changed to a slimmer version (reduces effectiveness) using an adaptor, as the 94mm space is still needed for the 90 degree turn from the horizontal to the vertical.

Important to note

- The appliance maybe fitted with another manufacturers ducting that has a rounded radius (please check compatibility before purchase). You will still need to purchase a **(Z821PD1)** diffuser.

DUCTED OUT EXTRACTION

Why use Ducted Out

Allows the removal of heat and moisture created by cooking, as well as grease and odour.

An improvement of extraction rate over recirculation modes* 615m³/h recirculation 622m³/h ducted out

*As per test parameters for the energy label declaration.

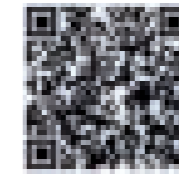

Maximum Drawer Depth 513mm with 70+ worktop

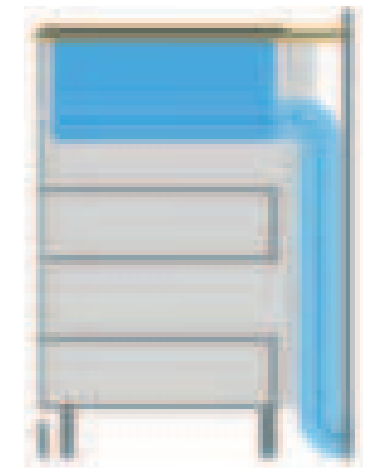

Installation considerations

What do I need?

- Starter Kit 3 **Z861KE1** (Includes 4 acoustic filters, radius bend, connector and 50cm straight channel).
- To complete your installation we can provide additional ducting lengths, connectors and adaptors.

Good to know

- It is also possible to use a fully ducted system, out of the kitchen.
- The acoustic filter kit is still required and is accessed the same way as the recirculation options.
- The Venting hob has been tested with a ducting run of 8 metres with 3 x 90 degree turns and maintaining efficient performance.
- We don't currently offer an external grid to go on the outside wall – this needs to be sourced independently.

Important to note

- The appliance maybe fitted with another manufacturers ducting that has a rounded radius (please check compatibility before purchase) You will still need to purchase **(Z811DU0)** x4 acoustic filters.

Venting Hobs

80CM V68FUX4L0

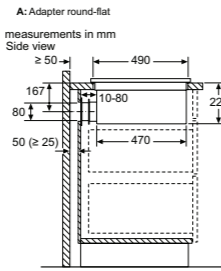
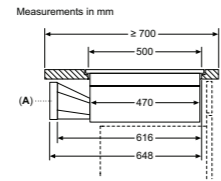
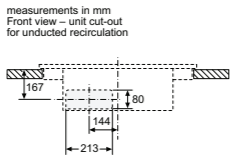
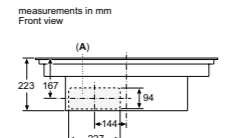

measurements in mm

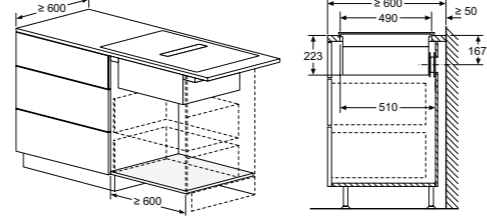

measurements in mm

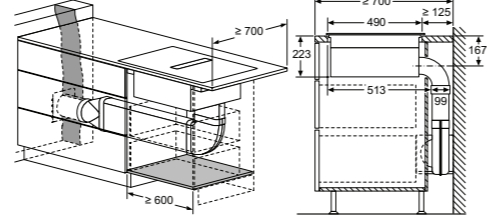

When installing directly against outer walls that are not insulated ($\mu \geq 0.5 \text{ W/m}^2 \cdot \text{C}$), we recommend using partially or fully ducted recirculation configurations.

80CM V58PHQ4C0, V58NHQ4L0, V58NBS1L0

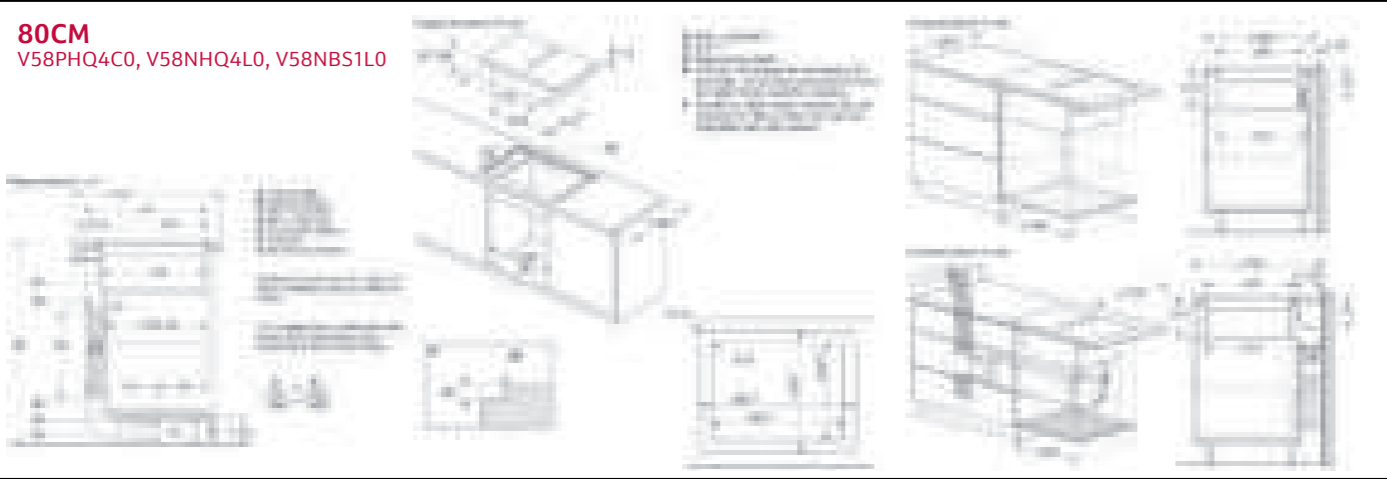

70CM V57THQ4L0

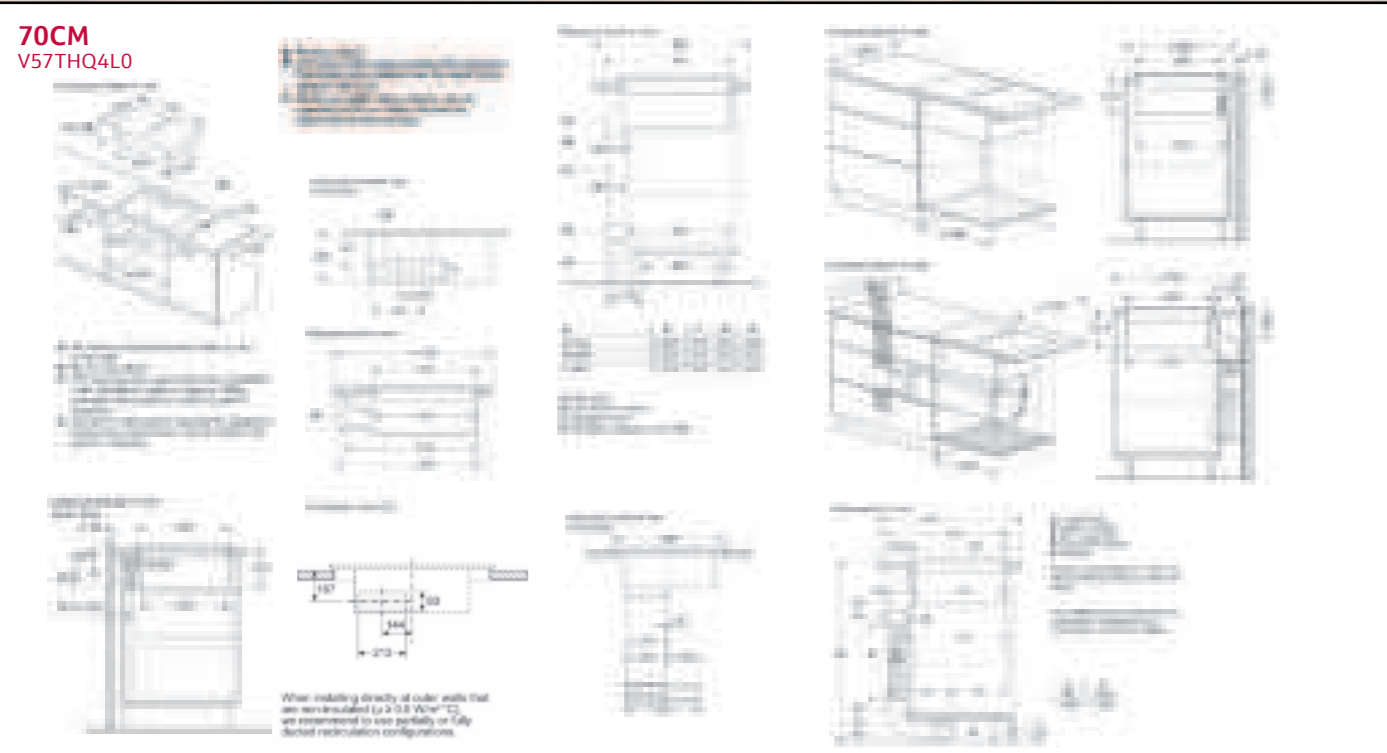

When installing directly at outer walls that are not insulated ($\mu \geq 0.5 \text{ W/m}^2 \cdot \text{C}$), we recommend using partially or fully ducted recirculation configurations.

60CM V56NBS1L0

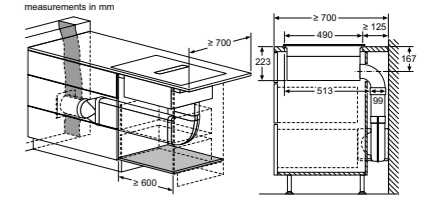
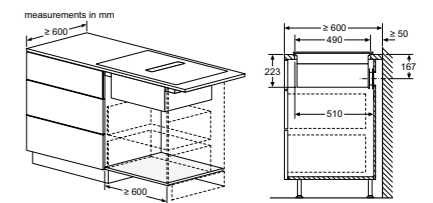
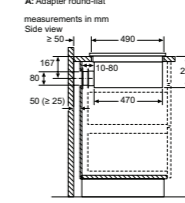
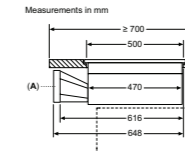
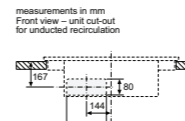
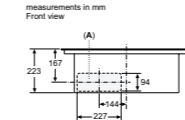
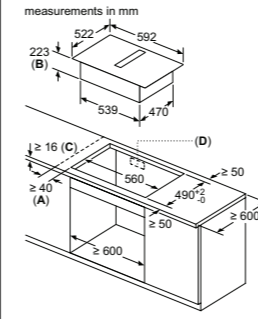

- A: Minimum distance from the hob cut-out to the wall
- B: Recessing depth
- C: The worktop into which the hob is installed must withstand loads of approx. 60kg; suitable substructures must be used if required
- D: Cut-out in back panel required for pipework. Exact size and position can be taken from specific drawing.

When installing directly against outer walls that are not insulated ($\mu \geq 0.5 \text{ W/m}^2 \cdot \text{C}$), we recommend using partially or fully ducted recirculation configurations.

70CM V57YHQ4C0

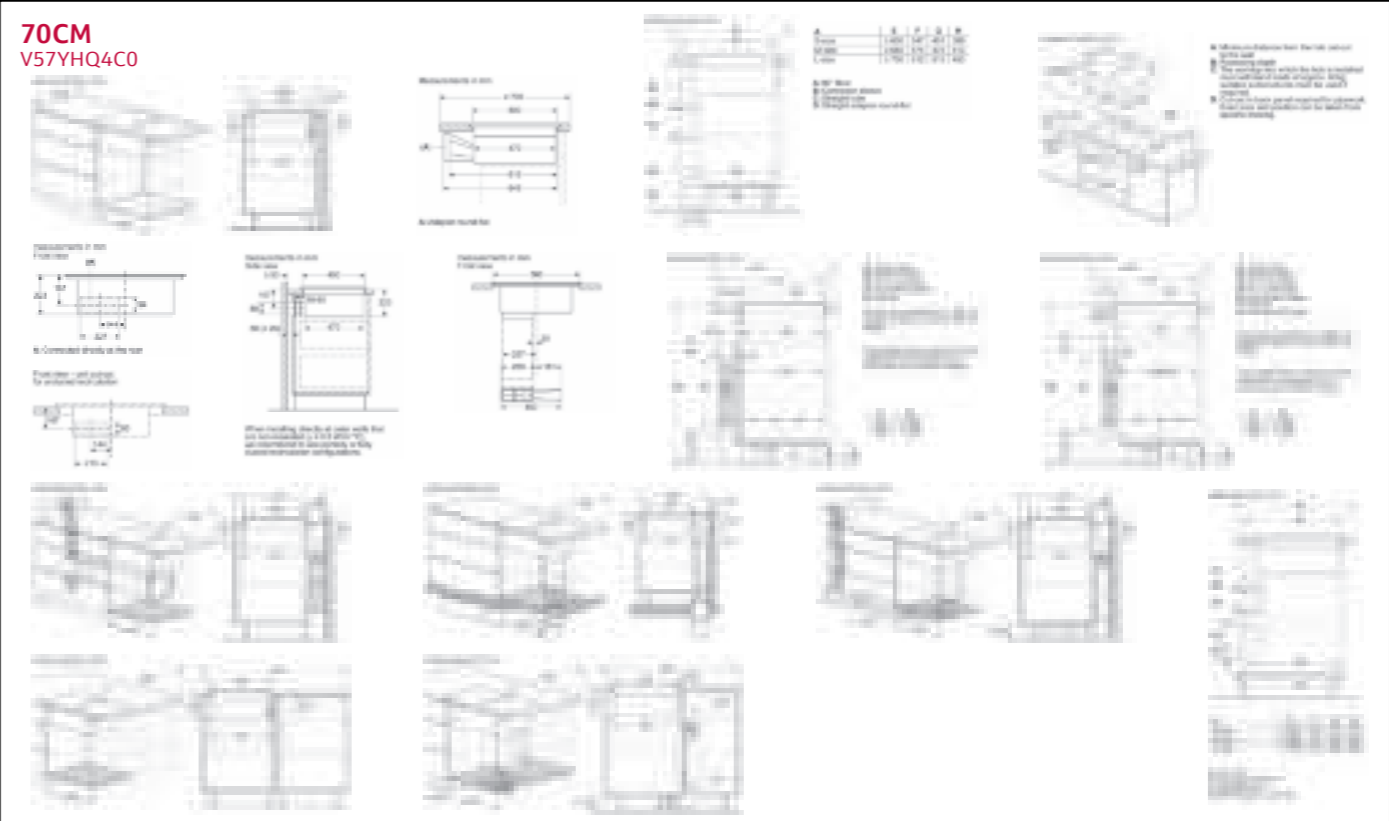

80CM V68YYX4C0, V68YYX4B0

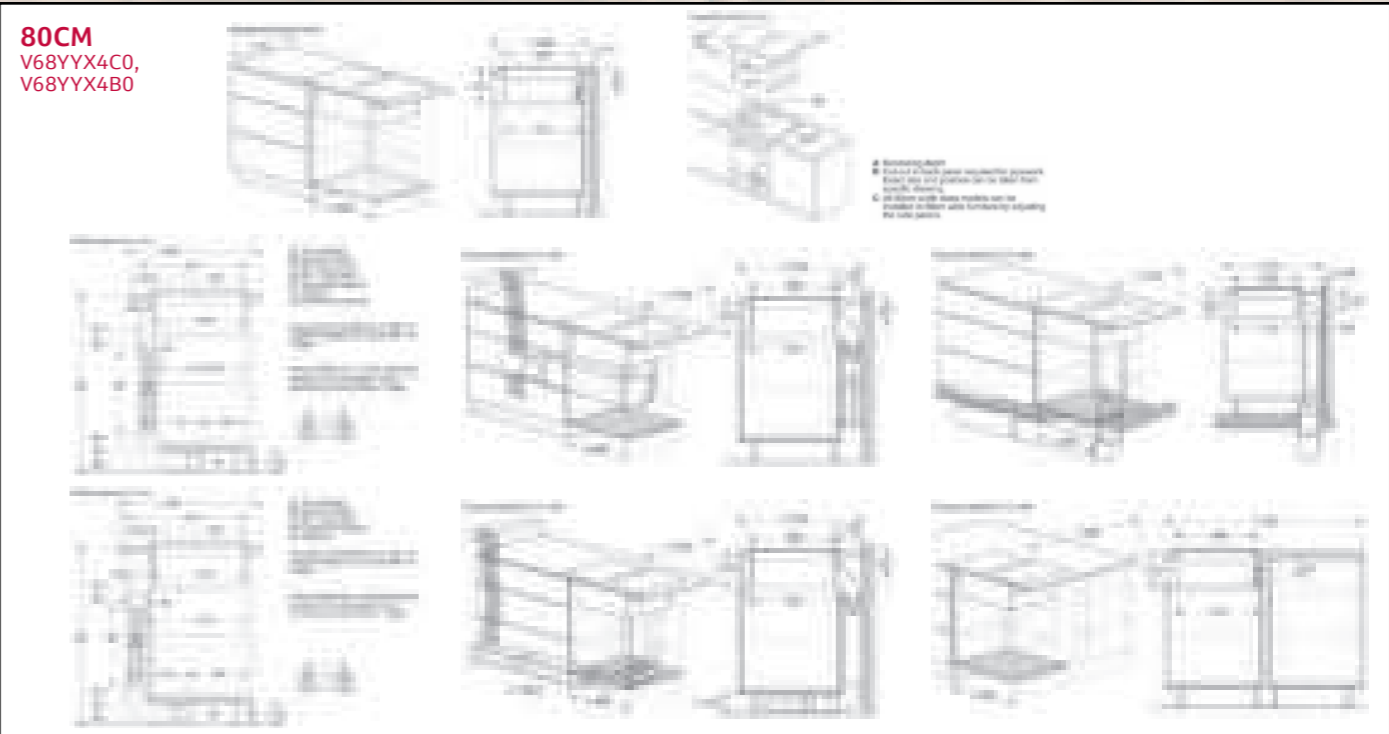

- 1: Recessing depth
- 2: Minimum distance from the hob cut-out to the wall
- 3: The worktop into which the hob is installed must withstand loads of approx. 60kg; suitable substructures must be used if required
- 4: Cut-out in back panel required for pipework. Exact size and position can be taken from specific drawing.

Venting Hobs Installation Options and Accessories

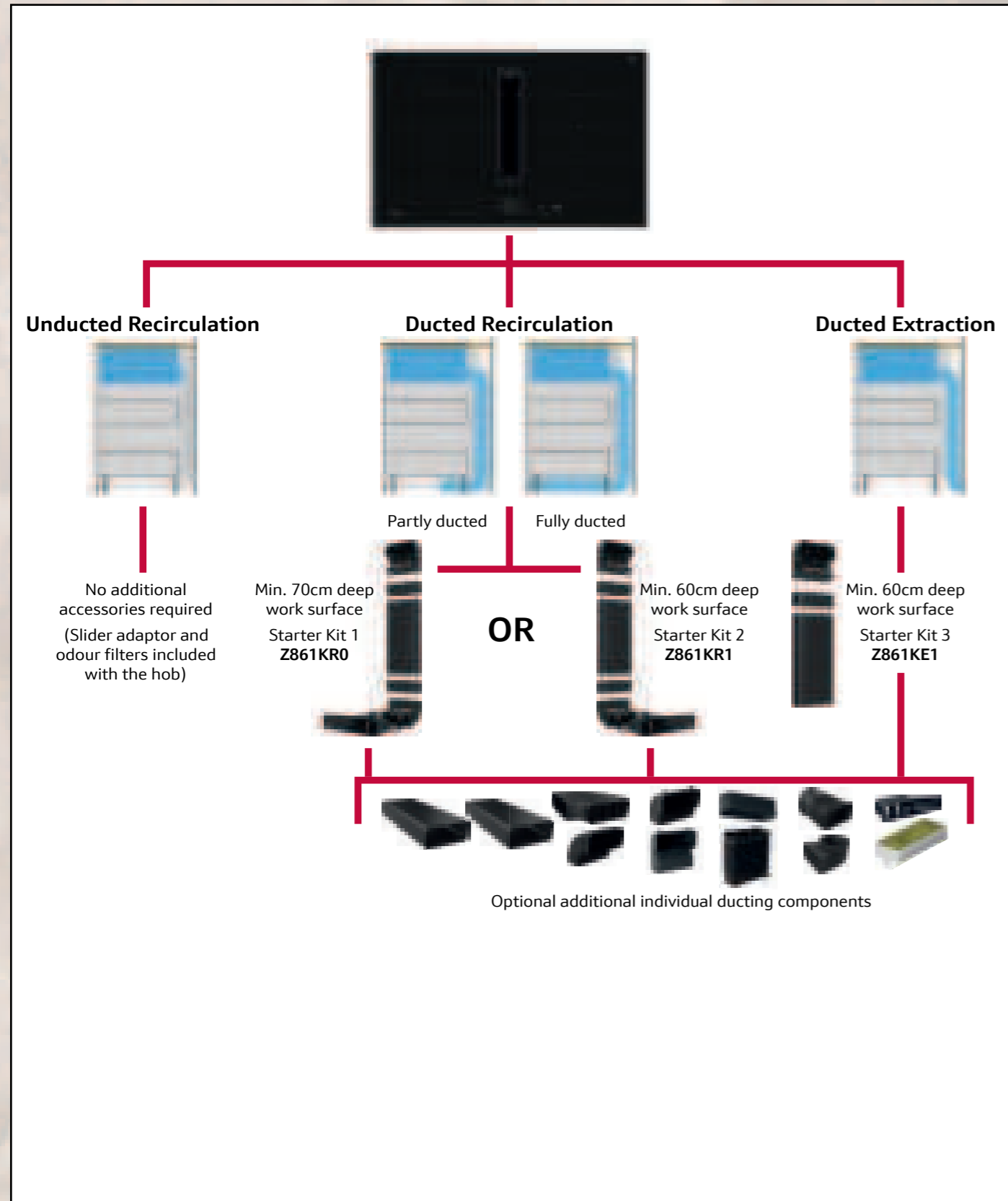

Venting Hobs Ducting Components

DESCRIPTION	CODE	MEASUREMENTS (mm)	COMPONENT
Flat channel ducting component, straight length, 100cm long Ducting component outlet size: 222mm x 89mm	Z861SM2		
Flat channel ducting component, straight length, 50cm long Ducting component outlet size: 222mm x 89mm	Z861SM1		
Flat channel 90° horizontal bend Ducting component outlet size: 222mm x 89mm	Z861SB1		
Flat channel 90° vertical bend (large Radius), suitable for 70cm worktop depths Ducting component outlet size: 222mm x 89mm	Z861SB2		
Flat channel 90° vertical bend (medium Radius), suitable for 65cm worktop depths Ducting component outlet size: 222mm x 89mm	Z861SB3		
Flat channel 90° vertical bend (short Radius), suitable for 60cm worktop depths Ducting component outlet size: 222mm x 89mm	Z861SB4		
Connection piece for use between ducting components and bends Ducting component size: 223mm x 90mm	Z861SS1		
Flexible Connection piece for use between ducting components and bends Ducting component size: 223mm x 90mm	Z861SS2		
Straight Adaptor / Converter flat to round (Ø 150mm) Ducting component outlet size: 222mm x 89mm	Z861S10		
90° Adaptor / Converter flat to round (Ø 150mm) Ducting component outlet size: 222 mm x 89mm	Z861S11		
Diffusor for ducted recirculation - outlet size: 222mm x 89mm	Z821PD1		
1 x set of CleanAir recirculation filters, Z811DU0 1 X set of Acoustic filters	Z821VR1		

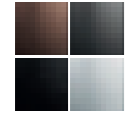

Flex Design Flex Induction Hobs



All Flex Design have a 5 year warranty

All Flex Design Venting Hobs require a set of Flex Design side trims to be ordered. All trims are a standard size and available in all 4 colours.

Finish	Model Number
Anthracite Grey	Z90802PFAY0
Brushed Bronze	Z90802PFBY0
Deep Black	Z90802PFDY0
Metallic Silver	Z90802PFMY0

KEY FEATURES	
Twist Pad Flex® required	•
Hob Hood Control	•
5" Full Touch colour display with Dish Categories	Via HC
Favourite Button	•
Smart Hood Automatic	•
Frying Sensor	11 settings
Power Move / Power Boost / PowerTransfer	/ ● / ●
Pan Boost	Via HC / Favourite Button
Number of Flex Induction zones	2
Extended Flex Induction Zone	
Number of Combi Induction zones	
FEATURES	
Number of individual zones	5
Power levels	17
Digital display / Adaptable Volume	Red / White Display / ●
Count up Timer	
Quick Start	•
Restart Function	•
Energy Consumption Display	
Main on/off switch	•
Quick-Off Function / Pause Function	/ ●
Pan Recognition	•
Demo Mode	•
Keep Warm Function	Via HC / Favourite Button
SAFETY FEATURES	
Residual Heat Indicator	•
Timer with automatic switch off for each zone	•
Control Panel Lock	•
Safety Time Switch off	•
PERFORMANCE / TECHNICAL INFORMATION	
Nominal voltage	V 220-240
Maximum power output	W 11,100
Electrical cable length	cm 110
Plug & Play with GB plug	
Rear left Flex Induction zone - power	kW/mm 2.20 200x230
Rear left zone power	kW/mm 2.20 200x230
Rear right Flex Induction zone - power	kW/mm 2.20 200x230
Rear right zone power	kW/mm 2.20 200x230
Rear Centre zone power	kW/mm 2.60, 300x240 2.20, 2.60, 3.30 210, 260, 320
Front Centre zone power	kW/mm 2.20 200x230
Front left Flex Induction zone - power	kW/mm 2.20 200x230
Front left zone power	kW/mm 2.20 200x230
Front right Flex Induction zone - power	kW/mm 2.20 200x230
Front right zone power	kW/mm 2.20 200x230
Flex Induction Zone left power	kW/mm 3.30 400x230
Flex Induction Zone right power	kW/mm 3.30 400x230
Extended Flex Induction rear left - power	kW/mm 3.30 400x230
Extended Flex Induction rear right - power	kW/mm 3.30 400x230
Combi Zone left power	kW/mm 3.30 400x230
Combi Zone right power	kW/mm 3.30 400x230
Rear left zone with Power Boost	(max. kW) 3.70 3.70
Rear right zone with Power Boost	(max. kW) 3.70 3.70
Rear Centre zone with Power Boost	(max. kW) 3.70 3.70
Front Centre zone with Power Boost	(max. kW) 3.70 3.70
Front left zone with Power Boost	(max. kW) 3.70 3.70
Front right zone with Power Boost	(max. kW) 3.70 3.70

90CM	
T69YYX4C0 N90	T69YYV4C0 N90
<ul style="list-style-type: none"> • Twist Pad Flex® • 3 Flex Zones • Hob Hood Control • Extended Frying Sensor 	<ul style="list-style-type: none"> • Twist Pad Flex® • 2 x Flex Zones & 32cm Triple Zone • Hob Hood Control • Extended Frying Sensor
•	•
•	•
Via HC	Via HC
•	•
•	•
11 settings	11 settings
/ ● / ●	/ ● / ●
Via HC / Favourite Button	Via HC / Favourite Button
2	2
5	5
17	17
Red / White Display / ●	Red / White Display / ●
•	•
•	•
•	•
•	•
/ ●	/ ●
•	•
•	•
Via HC / Favourite Button	Via HC / Favourite Button
•	•
•	•
•	•
•	•
220-240	220-240
11,100	11,100
110	110
2.20 200x230	2.20 200x230
2.20 200x230	2.20 200x230
2.20 200x230	2.20 200x230
2.60, 300x240	2.20, 2.60, 3.30 210, 260, 320
2.20 200x230	2.20 200x230
2.20 200x230	2.20 200x230
2.20 200x230	2.20 200x230
2.20 200x230	2.20 200x230
3.30 400x230	3.30 400x230
3.30 400x230	3.30 400x230
3.30 400x230	3.30 400x230
3.30 400x230	3.30 400x230
3.70 3.70	3.70 3.70
3.70 3.70	3.70 3.70
3.70 3.70	3.70 3.70
3.70 3.70	3.70 3.70
3.70 3.70	3.70 3.70
3.70 3.70	3.70 3.70

80CM		60CM	
T68YYY4C0 N90	T66YYY4C0 N70	T68YYY4C0 N90	T66YYY4C0 N70
<ul style="list-style-type: none"> • Twist Pad Flex® • 2 x Extended Flex Zones • Hob Hood Control • Extended Frying sensor 	<ul style="list-style-type: none"> • Twist Pad Flex® • 2 x Extended Flex • Hob Hood Control • Extended Frying sensor 		
•	•	•	•
•	•	•	•
Via HC	Via HC	Via HC	Via HC
•	•	•	•
•	•	•	•
11 settings	11 settings	11 settings	11 settings
/ ● / ●	/ ● / ●	/ ● / ●	/ ● / ●
Via HC / Favourite Button	Via HC / Favourite Button	Via HC / Favourite Button	Via HC / Favourite Button
2	2	2	2
4	4	4	4
17	17	17	17
Red / White Display / ●	Red / White Display / ●	Red / White Display / ●	Red / White Display / ●
•	•	•	•
•	•	•	•
•	•	•	•
/ ●	/ ●	/ ●	/ ●
•	•	•	•
•	•	•	•
Via HC / Favourite Button	Via HC / Favourite Button	Via HC / Favourite Button	Via HC / Favourite Button
•	•	•	•
•	•	•	•
•	•	•	•
•	•	•	•
220-240	220-240	220-240	220-240
7,400	7,400	7,400	7,400
110	110	110	110
2.20 200x230	2.20 190x230	2.20 200x230	2.20 190x230
2.20 200x230	2.20 190x230	2.20 200x230	2.20 190x230
2.20 200x230	2.20 190x230	2.20 200x230	2.20 190x230
3.30 400x230	3.30 380x230	3.30 400x230	3.30 380x230
3.30 400x230	3.30 380x230	3.30 400x230	3.30 380x230
3.30 300x300	3.30 300x300	3.30 300x300	3.30 300x300
3.30 300x300	3.30 300x300	3.30 300x300	3.30 300x300
3.70 3.70	3.70 3.70	3.70 3.70	3.70 3.70
3.70 3.70	3.70 3.70	3.70 3.70	3.70 3.70
3.10 3.70	3.70 3.70	3.10 3.70	3.70 3.70
3.70 3.70	3.70 3.70	3.70 3.70	3.70 3.70

All models comply with COMMISSION REGULATION (EC) No 1275/2008 with regard to ecodesign requirements for standby and off mode electric power consumption. 14.6kW power output (20A); Current management options for 16A, 13A or 10A connection.

Flex Induction Hobs

	90CM		80CM	
	T69FUV4L0 N90	T69FHV4L0 N70	T68NUV4A0 N90	
	<ul style="list-style-type: none"> • Anthracite Grey Twist Pad® • 2 x Flex Zones + 32cm Triple Zone • Extended Frying Sensor • Hob Hood Control • Smart Hood Automatic • Bevel Front 	<ul style="list-style-type: none"> • Twist Touch® Control • 2 x Flex Zones + 32cm Triple Zone • Extended Frying Sensor • Hob Hood Control • Smart Hood Automatic • Bevel Front 	<ul style="list-style-type: none"> • Anthracite Grey Twist Pad® • 1 x Flex Zones + 3 Zones • Extended Frying Sensor • Hob Hood Control • Smart Hood Automatic • Bevel Front 	NEW Matt BLACK
KEY FEATURES				
NEFF Home Connect	•	•	•	
Hob-Hood Control	•	•	•	
5" Full Touch colour display with Dish Categories	Via HC	Via HC	Via HC	
Favourite Button	•	•	•	
Smart Hood Automatic	•	•	•	
Extended Frying Sensor	11 settings	11 settings	11 settings	
Power Move / Power Boost / Power Transfer	/ ● / ●	/ ● / ●	/ ● / ●	
Pan Boost	Via HC / Favourite Button		Via HC / Favourite Button	
Number of Flex Induction zones	2+3 Triple ring zone	2+3 Triple ring zone	1	
Extended Flex Induction Zone				
Number of Combi Induction zones				
FEATURES				
Number of individual zones	5	5	5	
Power levels	17	17	17	
Digital display / Adaptable Volume	Red / White Display / ●	● / ●	Red / White Display / ●	
Count up Timer				
QuickStart	•	•	•	
Restart Function	•	•	•	
Energy Consumption Display	•	•	•	
Main on/off switch	•	•	•	
Quick-Off Function / Pause Function	/ ●	/ ●	/ ●	
Pan Recognition	•	•	•	
Demo Mode	•	•	•	
Keep Warm Function	Via HC / Favourite Button	Via HC / Favourite Button	Via HC / Favourite Button	
SAFETY FEATURES				
Residual Heat Indicator	•	•	•	
Timer with automatic switch off for each zone	•	•	•	
Control Panel Lock	•	•	•	
Safety Time Switch off	•	•	•	
PERFORMANCE / TECHNICAL INFORMATION				
Nominal voltage	V 220-240	220-240	220-240	
Maximum power output	W 11,100	11,100	7,400	
Electrical cable length	cm 110	110	110	
Plug&Play with GB plug				
Rear left Flex Induction zone - power	kW/mm 2.20	200x230	2.20	200x230
Rear left zone power	kW/mm		1.40	145
Rear right Flex Induction zone - power	kW/mm 2.20	200x230	2.20	200x210
Rear right zone power	kW/mm			
Rear Centre zone power	kW/mm 2.20, 2.60, 3.30	210, 260, 320	2.20, 2.60, 3.30	210, 260, 320
Front Centre zone power	kW/mm		2.20	240
Front left Flex Induction zone - power	kW/mm 2.20	200x230	2.20	200x230
Front left zone power	kW/mm		1.80	180
Front right Flex Induction zone - power	kW/mm 2.20	200x230	2.20	200x210
Front right zone power	kW/mm			
Flex Induction Zone left power	kW/mm 3.30	400x230	3.30	400x230
Flex Induction Zone right power	kW/mm 3.30	400x230	3.30	400x210
Extended Flex Induction rear left - power	kW/mm			
Extended Flex Induction rear right - power	kW/mm			
Combi Zone left power	kW/mm			
Combi Zone right power	kW/mm			
Rear left zone with Power Boost (max. kW)	3.70		3.70	2.20
Rear right zone with Power Boost (max. kW)	3.70		3.70	3.70
Rear Centre zone with Power Boost (max. kW)	3.70		3.70	3.70
Front Centre zone with Power Boost (max. kW)				
Front left zone with Power Boost (max. kW)	3.70		3.70	3.10
Front right zone with Power Boost (max. kW)	3.70		3.70	3.70

	80CM		60CM			
	T68FUV4L0 N90	T68FHV4L0 N70	T66NUX4A0 N90	T66FHX4L0 N70	T66FHE4L0 N70	
	<ul style="list-style-type: none"> • Anthracite Grey Twist Pad® • 1 x Flex Zones + 3 Zones • Extended Frying Sensor • Hob Hood Control • Smart Hood Automatic • Bevel Front 	<ul style="list-style-type: none"> • Twist Touch® Control • 1 x Flex Zone + 3 Zones • Extended Frying Sensor • Hob Hood Control • Smart Hood Automatic • Bevel Front 	<ul style="list-style-type: none"> • Anthracite Grey Twist Pad® • 2 x Flex Zones • Extended Frying Sensor • Hob Hood Control • Smart Hood Automatic • Bevel Front 	<ul style="list-style-type: none"> • Twist Touch® Control • 2 x Flex Zones • Extended Frying Sensor • Hob Hood Control • Smart Hood Automatic • Bevel Front 	<ul style="list-style-type: none"> • Twist Touch® Control • 1 x Flex Zone + 2 Zones • Extended Frying Sensor • Hob Hood Control • Smart Hood Automatic • Bevel Front 	
KEY FEATURES						
NEFF Home Connect	•	•	•	•	•	
Hob-Hood Control	•	•	•	•	•	
5" Full Touch colour display with Dish Categories	Via HC	Via HC	Via HC	Via HC	Via HC	
Favourite Button	•	•	•	•	•	
Smart Hood Automatic	•	•	•	•	•	
Extended Frying Sensor	11 settings	11 settings	11 settings	11 settings	11 settings	
Power Move / Power Boost / Power Transfer	/ ● / ●	/ ● / ●	/ ● / ●	/ ● / ●	/ ● / ●	
Pan Boost						
Number of Flex Induction zones	1	1	2	2	1	
Extended Flex Induction Zone						
Number of Combi Induction zones						
FEATURES						
Number of individual zones	5	5	4	4	4	
Power levels	17	17	17	17	17	
Digital display / Adaptable Volume	Red / White Display / ●	● / ●	Red / White Display / ●	● / ●	● / ●	
Count up Timer						
QuickStart	•	•	•	•	•	
Restart Function	•	•	•	•	•	
Energy Consumption Display	•	•	•	•	•	
Main on/off switch	•	•	•	•	•	
Quick-Off Function / Pause Function	/ ●	/ ●	/ ●	/ ●	/ ●	
Pan Recognition	•	•	•	•	•	
Demo Mode	•	•	•	•	•	
Keep Warm Function	Via HC / Favourite Button	Via HC / Favourite Button	Via HC / Favourite Button	Via HC / Favourite Button	Via HC / Favourite Button	
SAFETY FEATURES						
Residual Heat Indicator	•	•	•	•	•	
Timer with automatic switch off for each zone	•	•	•	•	•	
Control Panel Lock	•	•	•	•	•	
Safety Time Switch off	•	•	•	•	•	
PERFORMANCE / TECHNICAL INFORMATION						
Nominal voltage	V 220-240	220-240	220-240	220-240	220-240	
Maximum power output	W 7,400	7,400	7,400	7,400	7,400	
Electrical cable length	cm 110	110	110	110	110	
Plug&Play with GB plug						
Rear left Flex Induction zone - power	kW/mm 1.40	145	2.20	190x230	2.20	190x230
Rear left zone power	kW/mm		1.60	145		
Rear right Flex Induction zone - power	kW/mm 2.20	200x210	2.20	200x210	2.20	190x230
Rear right zone power	kW/mm				2.20	190x230
Rear Centre zone power	kW/mm 2.20	240	2.20	240		
Front Centre zone power	kW/mm				1.60	145
Front left Flex Induction zone - power	kW/mm 1.80	180	2.20	190x230	2.20	190x230
Front left zone power	kW/mm		2.00	180		
Front right Flex Induction zone - power	kW/mm 2.20	200x210	2.20	200x210	2.20	190x230
Front right zone power	kW/mm				2.20	190x230
Flex Induction Zone left power	kW/mm 3.30	380x230	3.30	380x230	3.30	380x230
Flex Induction Zone right power	kW/mm 3.30	380x230	3.30	380x230	3.30	380x230
Extended Flex Induction rear left - power	kW/mm					
Extended Flex Induction rear right - power	kW/mm					
Combi Zone left power	kW/mm					
Combi Zone right power	kW/mm					
Rear left zone with Power Boost (max. kW)	2.20		2.20		3.70	3.70
Rear right zone with Power Boost (max. kW)	3.70		3.70		3.70	2.20
Rear Centre zone with Power Boost (max. kW)	3.70		3.70			
Front Centre zone with Power Boost (max. kW)						
Front left zone with Power Boost (max. kW)	3.10		3.10		3.70	3.70
Front right zone with Power Boost (max. kW)	3.70		3.70		3.70	3.70

All models comply with COMMISSION REGULATION (EC) No 1275/2008 with regard to ecodesign requirements for standby and off mode electric power consumption. 14.6kW power output (20A); Current management options for 16A, 13A or 10A connection.



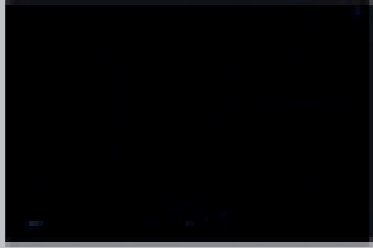
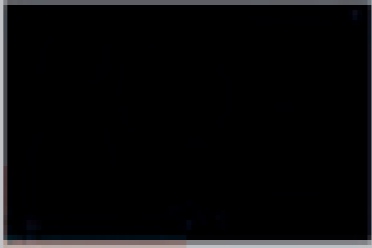

Induction Hobs

80CM

T58FHW1L0 N70	T58PHW1L0 N70
<ul style="list-style-type: none"> • Twist Touch® Control • CombiZone - 5 zones • Hob Hood Control • Smart Hood automatic • Bevel Front 	<ul style="list-style-type: none"> • Twist Touch® Control • CombiZone - 5 zones • Hob Hood Control • Smart Hood automatic • Flushline 

KEY FEATURES		T58FHW1L0 N70	T58PHW1L0 N70
NEFF Home Connect		•	•
Hob-Hood Control		•	•
5" Full Touch colour display			
Favourite Button		•	•
Smart Hood Automatic		•	•
Power Move / Power Boost / Power Transfer		/ • /	/ • /
Pan Boost			
Number of Combi Zones		1	1
FEATURES		T58FHW1L0 N70	T58PHW1L0 N70
Number of individual zones		5	5
Power levels		17	17
Digital display / Adaptable Volume		• / •	• / •
QuickStart		•	•
Restart Function		•	•
Main on/off switch		•	•
Quick-Off Function / Pause Function		/ •	/ •
Pan Recognition		•	•
Demo Mode		•	•
Keep Warm Function		Via HC / Favourite Button	Via HC / Favourite Button
SAFETY FEATURES		T58FHW1L0 N70	T58PHW1L0 N70
Residual Heat Indicator		•	•
Timer with automatic switch off for each zone		•	•
Control Panel Lock		•	•
Safety Time Switch off		•	•
PERFORMANCE / TECHNICAL INFORMATION		T58FHW1L0 N70	T58PHW1L0 N70
Nominal voltage	V	220-240	220-240
Maximum power output	W	7,400	7,400
Electrical cable length	cm	110	110
Plug&Play with GB plug			
Rear left Flex Induction zone - power	kW/mm		
Rear left zone - power	kW/mm	1.60	145
Rear right Flex Induction zone - power	kW/mm		
Rear right zone - power	kW/mm	2.50	190x210
Rear Centre zone - power	kW/mm	2.50	240
Front Centre zone - power	kW/mm		
Front left Flex Induction zone - power	kW/mm		
Front left zone - power	kW/mm	2.00	180
Front right Flex Induction zone - power	kW/mm		
Front right zone - power	kW/mm	2.50	190x210
Flex Induction Zone left - power	kW/mm		
Flex Induction Zone right - power	kW/mm		
Extended Flex Induction rear left - power	kW/mm		
Extended Flex Induction rear right - power	kW/mm		
Combi Zone left - power	kW/mm		
Combi Zone right - power	kW/mm	3.30	380x210
Rear left zone - with Power Boost	max. kW	2.20	2.20
Rear right zone - with Power Boost	max. kW	3.70	3.70
Rear Centre zone - with Power Boost	max. kW	3.70	3.70
Front Centre zone - with Power Boost	max. kW		
Front left zone - with Power Boost	max. kW	3.10	3.10
Front right zone - with Power Boost	max. kW	3.70	3.70

60CM

T56FHS1L0 N70	T36FBE1L0 N30	T36FBE1L0G N30	T36CA50X1U N30
<ul style="list-style-type: none"> • Twist Touch® Control • CombiZone - 4 zones • Hob Hood Control • Smart Hood automatic • Bevel Front 	<ul style="list-style-type: none"> • Touch Control • 4 zones <ul style="list-style-type: none"> • Bevel Front 	<ul style="list-style-type: none"> • Touch Control • 4 zones • Plug & Play with GB plug <ul style="list-style-type: none"> • Bevel Front 	<ul style="list-style-type: none"> • Touch Control • 4 zones / 1 boost zone • Plug & Play with GB plug <ul style="list-style-type: none"> • Frameless 

KEY FEATURES		T56FHS1L0 N70	T36FBE1L0 N30	T36FBE1L0G N30	T36CA50X1U N30
NEFF Home Connect		•			
Hob-Hood Control		•			
5" Full Touch colour display					
Favourite Button		•			
Smart Hood Automatic		•			
Power Move / Power Boost / Power Transfer		/ • /	/ • /	/ • /	/ Rear left only /
Pan Boost					
Number of Combi Zones		1			
FEATURES		T56FHS1L0 N70	T36FBE1L0 N30	T36FBE1L0G N30	T36CA50X1U N30
Number of individual zones		4	4	4	4
Power levels		17	17	17	9
Digital display / Adaptable Volume		• / •	• /	• /	• /
QuickStart		•	•	•	•
Restart Function		•	•	•	•
Main on/off switch		•	•	•	•
Quick-Off Function / Pause Function		/ •	• / •	• / •	• / •
Pan Recognition		•	•	•	•
Demo Mode		•			
Keep Warm Function		Via HC / Favourite Button			
SAFETY FEATURES		T56FHS1L0 N70	T36FBE1L0 N30	T36FBE1L0G N30	T36CA50X1U N30
Residual Heat Indicator		•	•	•	•
Timer with automatic switch off for each zone		•	•	•	•
Control Panel Lock		•	•	•	•
Safety Time Switch off		•	•	•	•
PERFORMANCE / TECHNICAL INFORMATION		T56FHS1L0 N70	T36FBE1L0 N30	T36FBE1L0G N30	T36CA50X1U N30
Nominal voltage	V	220-240	220-240	220-240	220-240
Maximum power output	W	6,900	4,600	3,700	3,700
Electrical cable length	cm	110	110	110	110
Plug&Play with GB plug				•	•
Rear left Flex Induction zone - power	kW/mm				
Rear left zone - power	kW/mm	2.50	190x210	1.80	180
Rear right Flex Induction zone - power	kW/mm				
Rear right zone - power	kW/mm	1.60	145	1.40	145
Rear Centre zone - power	kW/mm				
Front Centre zone - power	kW/mm				
Front left Flex Induction zone - power	kW/mm				
Front left zone - power	kW/mm	2.50	190x210	1.80	180
Front right Flex Induction zone - power	kW/mm				
Front right zone - power	kW/mm	2.00	180	2.20	210
Flex Induction Zone left - power	kW/mm				
Flex Induction Zone right - power	kW/mm				
Extended Flex Induction rear left - power	kW/mm				
Extended Flex Induction rear right - power	kW/mm				
Combi Zone left - power	kW/mm				
Combi Zone right - power	kW/mm	3.60	380x210		
Rear left zone - with Power Boost	max. kW	3.70	3.10	3.00	3.10
Rear right zone - with Power Boost	max. kW	2.20	2.20	2.20	
Rear Centre zone - with Power Boost	max. kW				
Front Centre zone - with Power Boost	max. kW				
Front left zone - with Power Boost	max. kW	3.70	3.10	3.00	
Front right zone - with Power Boost	max. kW	3.10	3.70	3.00	

THE NEFF OVEN COLLECTIONS

HOBES

VENTILATION

REFRIGERATION

DISHWASHING

LAUNDRY

All models comply with COMMISSION REGULATION (EC) No 1275/2008 with regard to ecodesign requirements for standby and off mode electric power consumption. 14.6kW power output (20A); Current management options for 16A, 13A or 10A connection.

Ceramic Hobs

60CM
T16NBE1L | N50

- Touch Control
- 4 zones

- Frameless



FEATURES			
Number of individual zones		4	
No. of dual zones			
No. of extendable zones			
Power Boost			
Power levels		17	
Digital display		•	
Restart function		•	
Energy consumption display			
Main on/off switch		•	
Keep warm function			
SAFETY FEATURES			
Residual heat indicator		•	
Timer with automatic switch off for each zone		•	
Control panel lock		•	
Safety time switch off		•	
Wipe protection function			
PERFORMANCE/TECHNICAL INFORMATION			
Nominal voltage	V	220-240	
Maximum power output	W	6,600	
Electrical cable length	cm	110	
Plug&Play with GB plug			
Rear left zone	kW/mm	2.00	180
Rear right zone	kW/mm	1.20	145
Rear centre zone	kW/mm		
Front centre zone	kW/mm		
Front left zone	kW/mm	1.20	145
Front right zone	kW/mm	2.20	210
Rear left zone – with Power Boost	max. kW		
Rear right zone – with Power Boost	max. kW		
Rear centre zone – with Power Boost	max. kW		
Front centre zone – with Power Boost	max. kW		
Front left zone – with Power Boost	max. kW		
Front right zone – with Power Boost	max. kW		



Induction Cookware Accessories Range

Excellent accessories that perform as well as your hob does.

This range of Induction Cookware Accessories are designed to perfectly fit Flex Induction and Induction hobs. The rectangular shapes **perfectly fit into the flex zones**. The large flex pans **fits perfectly in the rails of our oven**.

All accessories are **oven-proof up to 220°C** with a **non-stick coating** that cooks your food perfectly while also being **easy to clean**.*

The pans are designed to be **easily stacked** to maximise your storage space.

* not suitable for dishwasher cleaning.



Double Flex Pans Set (4 Pans)

Includes:

- Flex Pan Large
- Flex Pan Medium
- 2x Flex Pan small with lid.

Z9404FF0



Single Flex Pans Set (3 Pans)

Includes:

- Flex Pan Medium
- 2x Flex Pan small with lid.

Z9403FF0

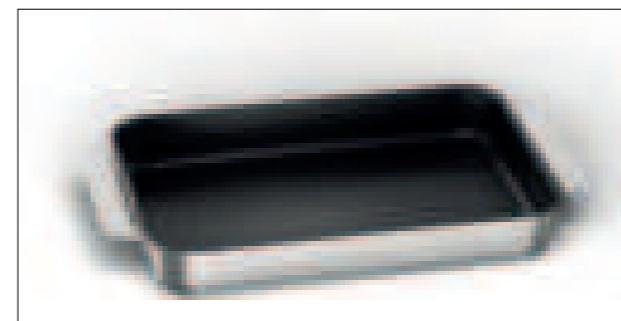

Large Pan

Very large frying surface for cooking big portions like for meat fish and more.

Z9401FF0



Teppan Yaki

- Oven proof up to 220C.
- Excellent non-stick properties
- Even heat distribution
- Easy to clean

Z9401TY0

Flex Design Hobs - Flex Induction

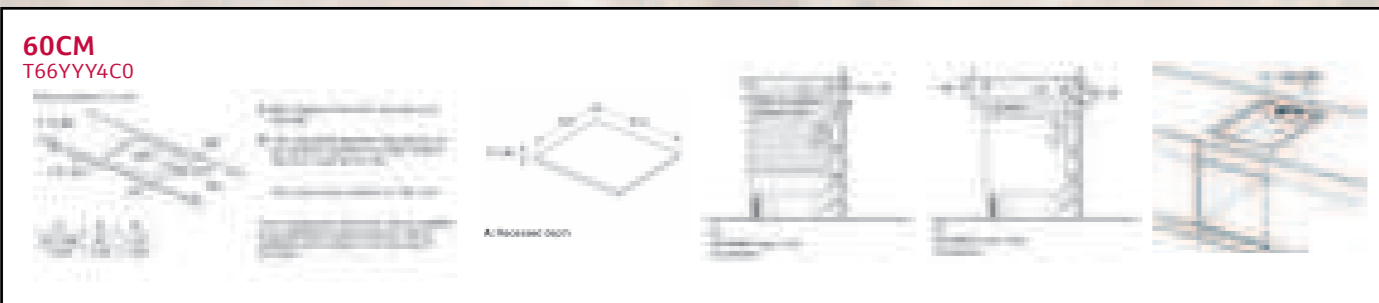
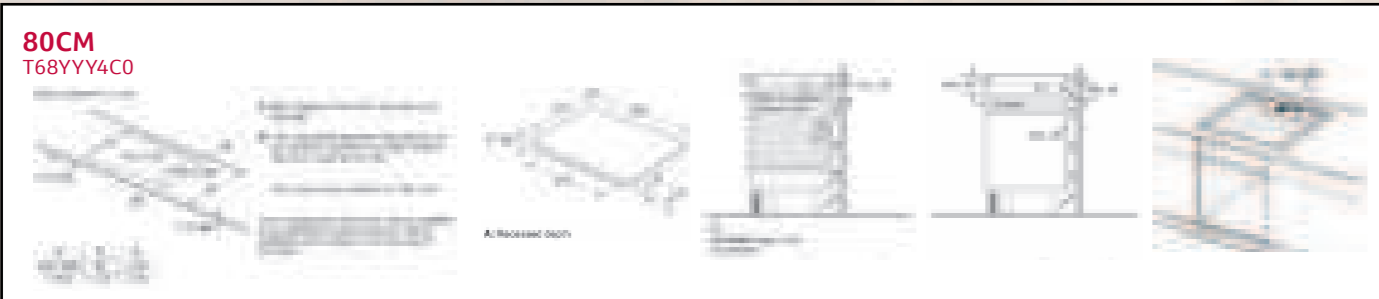

Flex Induction Hobs



Induction & Ceramic Hobs

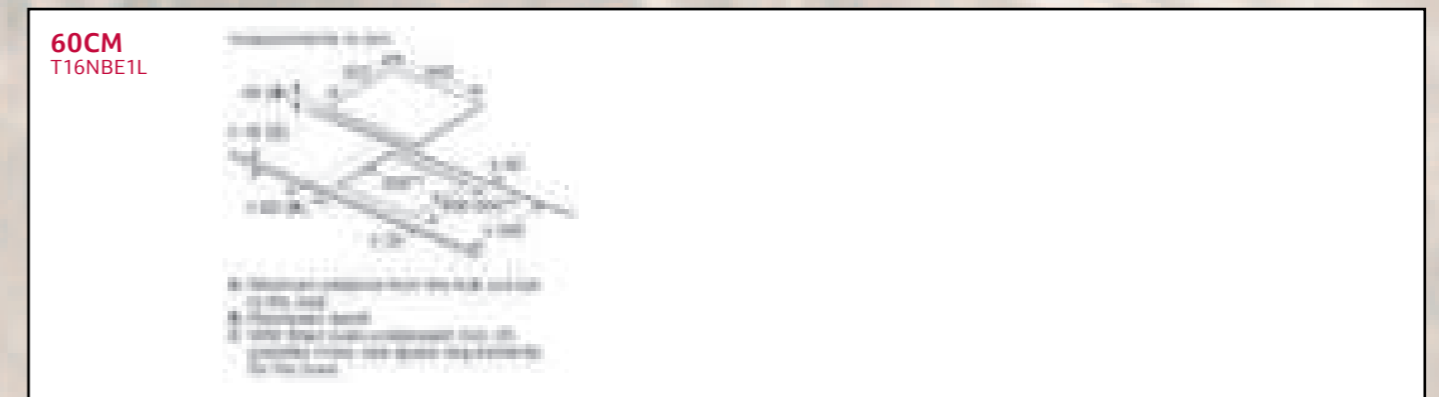
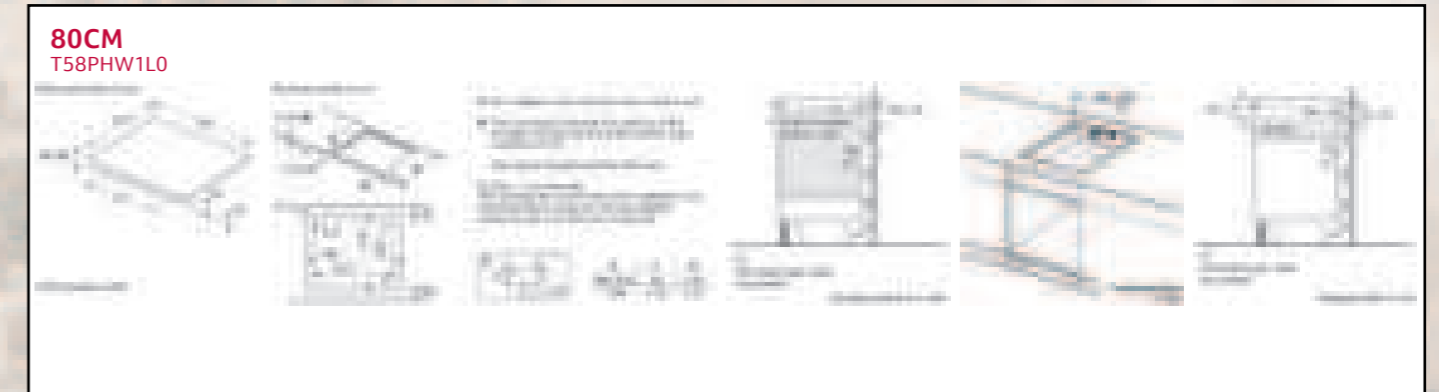

Flex Induction Accessories

Spanning the length of your Flex Induction zone, our accessories are designed to inspire you in the kitchen. From everyday cooking to theatrical displays, there's an accessory to bring out the best in your favourite dishes.

Product	Description	Material	Code	Part Number
 <p>Griddle Plate</p>	<p>Surface Area 41.5 x 26.5cm</p> <p>Ideal for cooking steaks, fish, flatbreads and sliced vegetables, an induction griddle plate offers considerably more flexibility than a standard square griddle pan. All accessories within our induction range are easy to clean and dishwasher safe.</p>	Cast Iron	Z9416X2	17000339

Saucepans

Ferrous metal saucepans are required for use on an induction hob. To check if a saucepan can be used with an induction hob use our quick magnetic test. Also, if a saucepan made of unsuitable material is placed on the selected hotplate, the power level displayed on the hotplate indicator will flash. NEFF saucepans have been tried and tested to ensure that they offer optimum performance with NEFF hobs.

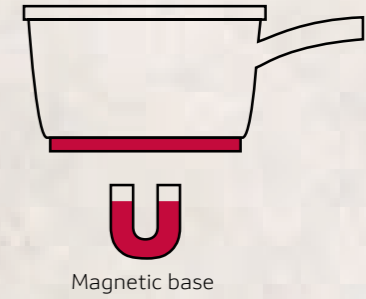

Product	Description	Material	Code	Part Number
 <p>3 Piece Pan Set</p>	2 x pots, 1 x Pan	Stainless steel	Z943SE0	17004098
 <p>4 Piece Pan Set</p>	1 x Saute pan, 2 x Pots with lids, 1 x milk pan	Stainless steel	Z9404SE0	17005721
 <p>6 Piece Pan Set</p>	2 x Saute pan, 3 x Pots with lids, 1 x milk pan	Stainless steel	Z9406SE0	17005724
 <p>18.5 cm Non Stick Frying Pan</p>		Cast Iron	Z9428FE0	17005718

Cook wild. CLEAN EASY

Master every meal with the NEFF Gas Hob range. Cook as passionately as you like without worrying about the clean-up afterwards.

Take your cooking to the next level with our gas hobs. Our Flame Select® technology gives you nine precise heat control levels. One advantage is that it prevents uncontrolled boiling or splashing, which makes cleaning up after cooking easier. And if your cooking does get a bit wild, don't worry. Our Comfort Clean features simplify the cleaning process with removable dials and pan supports suitable for the dishwasher. Savour the moments that matter and enjoy traditional cooking with a flame thanks to the ease of modern technology.

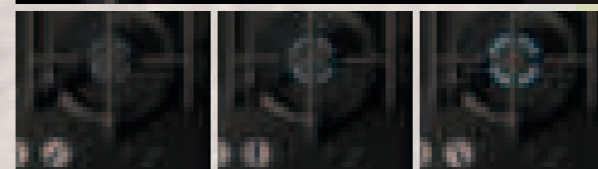

COMFORT CLEAN

Simplifies your cleaning process.

With the NEFF gas hobs, cleaning becomes much easier. The **removable Metallic Dials** and **dishwasher-safe Pan Supports** are designed for easy cleaning and maintenance. This way, you cook as passionately as you want without worrying about the clean-up afterwards.

Illuminated* Metallic Sword Dials

Our Illuminated Metallic Sword Dials are crafted from robust metal. Not only do they offer precision control over 9 power levels, but they also light up when the burner is on, making your cooking experience effortless. And the cherry on top? They're removable for easy cleaning. So, get ready to cook your culinary highlights without any clean-up worries!

FLAME SELECT®

Nine flames, infinite possibilities.

The Flame Select® technology regulates the gas output precisely. And because the amount of gas in each of the 9 levels is defined, you'll get the same cooking results over and over again. Another benefit of this precise steering is that it prevents uncontrolled boiling or splashing, which makes cleaning after cooking much easier.



Cast Iron Pan Supports

Don't worry about wobbly cookware. Our Cast Iron Pan Supports are built to steady your cookware while you focus on creating culinary masterpieces. Simply pop them in the dishwasher when you're done. Just pure cooking joy.



Introducing the first gas hob with WI-FI CONNECTIVITY

Our new gas hob is the first in the NEFF lineup to feature Wi-Fi connectivity, allowing for seamless pairing with our smart hoods.

HOB-HOOD CONTROL*

More creativity, less complexity.

The NEFF hood that automatically adjusts its fan speed based on the output of the compatible hob, ensuring optimal ventilation without manual adjustments.

TOUCH CONTROL DISPLAY*

Effortless precision at your fingertips.

The Touch Control Display offers a sleek, intuitive way to manage your cooking settings. With just a simple touch, you can set a timer or adjust the light and power level of your matching hood, making your cooking process smooth and enjoyable.

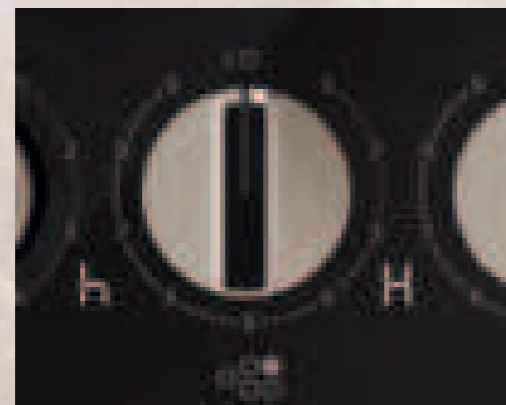
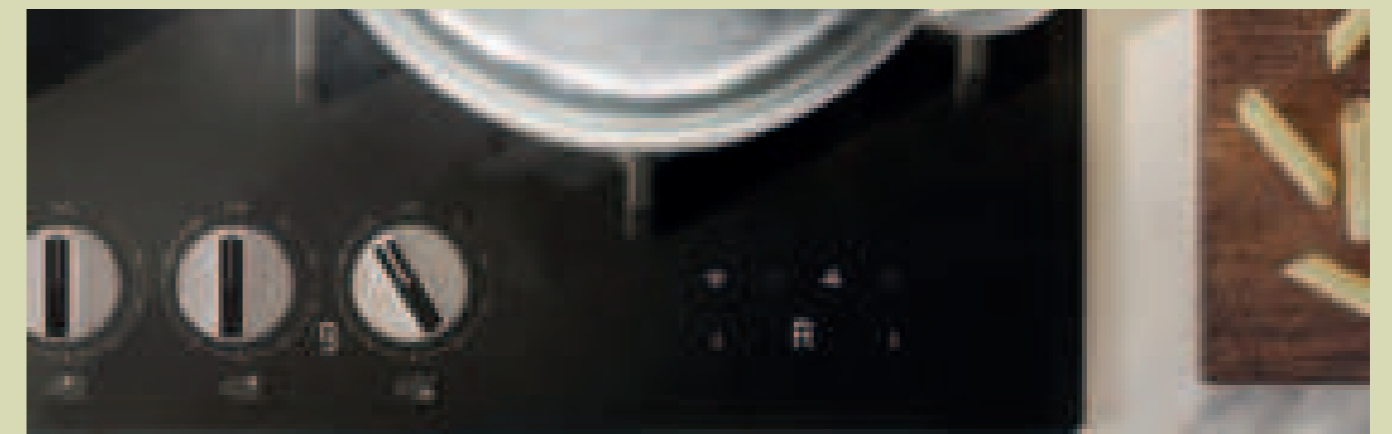

RESIDUAL HEAT INDICATOR*

Safety first, always.

Each burner's Residual Heat Indicator alerts you when the hob is still hot after use, helping to prevent accidental burns. This simple yet essential feature ensures that your cooking experience is as safe as it is fun.

GAS SAFETY CUT-OFF

Ease of mind all the time.

With the Gas Safety Cut-Off, your hob automatically shuts off the gas supply if the flame is accidentally extinguished, e.g. by some draft. This crucial safety feature gives you peace of mind, allowing you to focus on your culinary creations without worry.

TEMPERED GLASS SURFACE

Durability meets safety.

Safety Glass provides a robust and heat-resistant surface that enhances the look and durability of your hob. Designed to withstand the rigors of everyday cooking, ensuring your kitchen remains safe and stylish.

MONITORING ON/OFF STATUS VIA THE NEFF HOME CONNECT APP

Stay connected.

Take control of your cooking experience with the NEFF Home Connect App. Whether in another room or on the go, you can monitor your hob's settings from your smartphone, ensuring your kitchen is always under control.

ILLUMINATED METALLIC SWORD DIALS & DISPLAY*

Elegant 24/7

Enhance your cooking experience with Illuminated Metallic Sword Dials, which not only provide a luxurious feel but also ensure precise control – even in low light. Paired with the Display, you can easily monitor your settings at a glance, making cooking both stylish and intuitive.

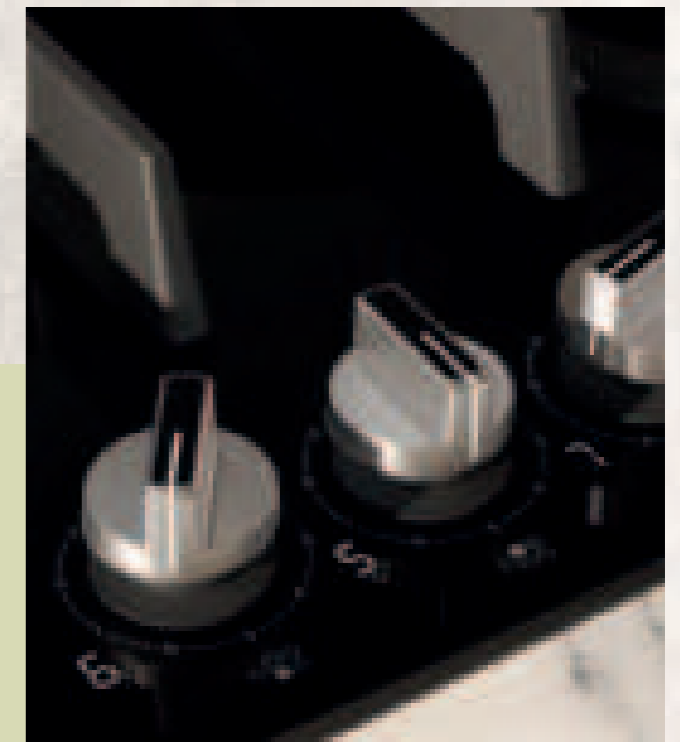

Control, Connectivity, Elegant – NEFF Gas Hobs Range at a glance

Choosing the right Gas Hob for you

NEFF offers metallic removable dials for classic heat control as well as easy cleaning. Wi-fi enabled, Hob-Hood control, Residual heat indicators and more allow you to choose the perfect option for you and your kitchen.

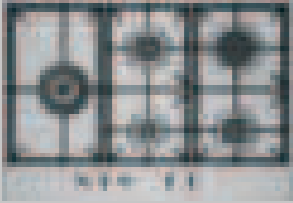
HOB TYPE	VALUE CLASS	FINISH	90CM	75CM	60CM
 <p>GAS HOBS Combining the precision and familiarity of gas cooking with refined, contemporary design, our gas hobs are available in two distinctive finishes. Choose the sleek sophistication of black glass for a modern, elegant look, or opt for stainless steel for a durable, timeless aesthetic. Both options deliver the trusted performance of gas with a finish to suit every kitchen style.</p> 	N90	Black Glass	T29RHS4S0 5 Burner, Flag Layout, Flame Select, 5kW Wok Burner		
	N70	Black Glass		T27PIQ4S0 5 Burner, Star Layout, Flame Select, 4kW Wok Burner	T26PIP4S0 4 Burner, Flame Select
				T27CIQ8S0 5 Burner, Star Layout, 4kW Wok Burner, Flame Select	T26CIP8S0 4 Burner, Flame Select
	N70	Stainless Steel	T29CIR8N0 5 Burner, Star Layout, Flame Select, 5kW Wok Burner	T27CIQ8N0 5 Burner, Star Layout, 4kW Wok Burner, Flame Select	T26CIH8N0 4 Burner, 3.5kW Wok Burner, Flame Select
				T27CIS8N0 5 Burner, 5kW Wok Burner, Flag Layout, Flame Select	T26CIP8N0 4 Burner, Flame Select
	N50	Black Glass			T26NKP4S0 4 Burner
Stainless Steel				T26GKH8N0 4 Burner, 3.3kW Wok Burner	
N30	Stainless Steel			T26BKP6S0 4 Burner, Side Control	

GAS HOBS

Guide To Gas Hobs

Gas Hobs

AVAILABLE IN 90CM, 75CM AND 60CM SIZES.



Featured model: T27PIQ4S0 N70 75cm Gas Hob

Gas Hobs Finishes

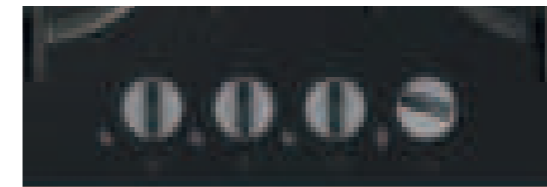

Black Tempered Glass / Black Cast Iron Supports



Black Enamel Surface / Black Cast Iron Finish Supports



Stainless Steel / Black Cast Iron Supports

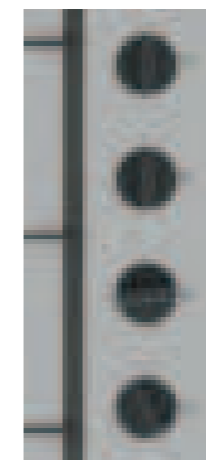

Stainless Steel / Black Cast Iron Supports Side Control

Gas Features



FLAME SELECT®

Cook everything just right with 9-level Flame Select®. With Flame Select® the gas flame adapts to your cooking, offering precise control every time. For the first time ever, cooking with gas is as easy as cooking on an electric hob.

POWER LEVEL DISPLAY

Some gas hobs benefit from a host of features that are usually found on ceramic hobs, including an LED display. The residual heat indicator displays if there is any residual heat on the hob. In the event of a problem with the individual burner the indicator lights also act as warning lights.

HIGH SPEED BURNERS

Provide a surge of extra power; particularly useful for boiling a large pan of water quickly.



WOK BURNER

The secret of Chinese stir fry cooking is heat and speed. Our Domino wok (N23TS19N0) delivers 6.0kW.

FLAME CONTROL

The flame failure safety device shuts down the supply of gas to the hob if the flame goes out for any reason. The automatic reignition uses a heat sensor to detect if the flame goes out and, if so, will automatically attempt to reignite.

CAST IRON PAN SUPPORTS

Firmly hold the pan above the flame, leaving space between the base and the burner. They're used on the majority of our models because of their robust and sturdy nature and tolerance to prolonged contact with heat.

EASY GRIP CONTROLS

Ergonomically designed to be gripped and turned easily, even with wet or greasy hands.

SIMMER SETTING

Excellent for slow simmering, almost all of our gas hobs have a very low burner with a maximum of just 1.0kWh.



THE NEFF OVEN COLLECTIONS

HOBS

VENTILATION

REFRIGERATION

DISHWASHING



LAUNDRY

Gas Hobs

90CM

	T29RHS4S0 N90	T29CIR8N0 N70
	<ul style="list-style-type: none"> • Touch Control • Black/Stainless steel Top Trim • 5 burner • 5.0kW Wok Burner • Hob Hood Control • Smart Hood Automatic • Dishwasher Proof cast iron supports • Flag layout • Flame Select® • Easy Clean • Biomethane Ready • Residual Heat Indicator 	<ul style="list-style-type: none"> • Stainless Steel • 5 burner • 5.0kW Wok Burner • Cast iron supports • Star layout • Flame Select® • Easy Clean • Biomethane Ready 
Control position	Front	Front
Dial Type	Illuminated metallic detachable	Detachable metallic
Control Type	Touch Control (7-segment display)	
Hob surface type	Tempered glass	Metal
KEY FEATURES		
Flame Select®	•	•
Digital power level display	•	
Number of dual circuit wok style burners	1	1
High power (5.0kW+) wok burner	•	•
Dual control wok burner	•	•
NEFF Home Connect	•	
Hob-Hood Control	•	
Smart Hood Automatic	•	
Count-down Timer	•	
FEATURES		
Number of cooking zones	5	5
Individual power levels	9	9
Variable power levels		
Ignition via control dials	•	•
Flame failure safety device	•	•
Cast iron pan supports (number)	5	3
Cast iron finish pan supports (number)		
Pan Supports Dishwasher safe	•	•
PERFORMANCE / TECHNICAL INFORMATION		
Nominal voltage	V 220-240	V 220-240
Maximum gas power output load	W 13700	W 12500
Total connected electrical load	max. W 2.0	1.1
Cable length	cm 100	150
GB plug		
Left burner power	kW 5.00	
Front left burner power	kW	1.00
Back left burner power	kW	1.75
Centre/Centre front burner power	kW 1.75	5.00
Centre back burner power	kW 7.75	
Front right burner power	kW 1.00	1.75
Back right burner power	kW 3.00	3.00
Right burner power	kW	
Pre-set for natural gas	•	•
CE Marked	•	•
STANDARD ACCESSORY		
LPG jets	mbar 28-30 / 37	28-30 / 37
OPTIONAL ACCESSORY		
Wireless Meatprobe	Z1365WX0	Z1365WX0

75CM

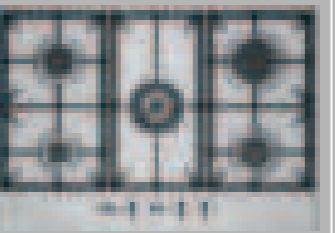
	T27PIQ4S0 N70	T27CIQ8S0 Black T27CIQ8N0 Stainless Steel N70	T27CIS8N0 N70
	<ul style="list-style-type: none"> • Black Tempered Glass • 5 burner • 4.0kW Wok Burner • Cast iron supports • Star layout • Flame Select® • Easy Clean • Biomethane Ready 	<ul style="list-style-type: none"> • Black / Stainless Steel • 5 burner • 4.0kW Wok Burner • Cast iron supports • Star layout • Flame Select® • Easy Clean • Biomethane Ready 	<ul style="list-style-type: none"> • Stainless Steel • 5 burner • 5.0kW Wok Burner • Cast iron supports • Flag layout • Flame Select® • Easy Clean • Biomethane Ready 
Control position	Front	Front	Front
Dial Type	Detachable metallic	Detachable metallic	Detachable metallic
Control Type			
Hob surface type	Tempered glass	Black Enamel / Metal	Metal
KEY FEATURES			
Flame Select®	•	•	•
Digital power level display			
Number of dual circuit wok style burners	1	1	1
High power (5.0kW+) wok burner			•
Dual control wok burner	•	•	•
NEFF Home Connect			
Hob-Hood Control			
Smart Hood Automatic			
Count-down Timer			
FEATURES			
Number of cooking zones	5	5	5
Individual power levels	9	9	9
Variable power levels			
Ignition via control dials	•	•	•
Flame failure safety device	•	•	•
Cast iron pan supports (number)	3	3	3
Cast iron finish pan supports (number)			
Pan Supports Dishwasher safe	•	•	•
PERFORMANCE / TECHNICAL INFORMATION			
Nominal voltage	V 220-240	V 220-240	V 220-240
Maximum gas power output load	W 11,500	W 11,500	W 12,500
Total connected electrical load	max. W 1.10	1.10	1.10
Cable length	cm 100	100	100
GB plug			
Left burner power	kW		5.00
Front left burner power	kW 1.00	1.00	
Back left burner power	kW 1.75	1.75	
Centre/Centre front burner power	kW 4.00	4.00	1.00
Centre back burner power	kW		1.75
Front right burner power	kW 1.75	1.75	
Back right burner power	kW 3.00	3.00	3.00
Right burner power	kW		
Pre-set for natural gas	•	•	•
CE Marked	•	•	•
STANDARD ACCESSORY			
LPG jets	mbar 28-30 / 37	28-30 / 37	28-30 / 37
OPTIONAL ACCESSORY			
Wireless Meatprobe	Z1365WX0	Z1365WX0	Z1365WX0

THE NEFF OVEN COLLECTIONS

HOBES

VENTILATION



REFRIGERATION

DISHWASHING

LAUNDRY

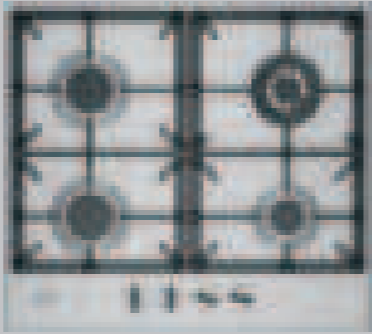
Gas Hobs

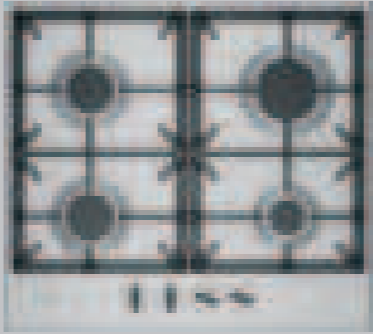
	60CM	
	T26PIP4S0 N70	T26CIH8N0 N70
	<ul style="list-style-type: none"> • Black Tempered Glass • 4 burner • Cast iron supports • Flame Select® • Easy Clean • Biomethane Ready 	<ul style="list-style-type: none"> • Stainless Steel • 4 burner • 3.5kW Wok Burner • Cast iron supports • Flame Select® • Easy Clean • Biomethane Ready 
Control position	Front	Front
Dial Type	Detachable metallic	Detachable metallic
Hob surface type	Tempered glass	Metal
KEY FEATURES		
Flame Select®	•	•
Digital power level display		
Number of dual circuit wok style burners		1
High power (5.0kW+) wok burner		
Dual control wok burner		•
FEATURES		
Number of cooking zones	4	4
Individual power levels	9	9
Variable power levels		
Ignition via control dials	•	•
Flame failure safety device	•	•
Cast iron pan supports (number)	4	2
Cast iron finish pan supports (number)		
Pan Supports Dishwasher safe	•	•
PERFORMANCE / TECHNICAL INFORMATION		
Nominal voltage	V	220-240
Maximum gas power output load	W	7,500
Total connected electrical load	max. W	1.10
Cable length	cm	100
Plug&Play with GB plug		
Left burner power	kW	
Front left burner power	kW	1.75
Back left burner power	kW	1.75
Centre/Centre front burner power	kW	
Centre back burner power	kW	
Front right burner power	kW	1.00
Back right burner power	kW	3.00
Right burner power	kW	
Pre-set for natural gas		•
CE Marked		•
STANDARD ACCESSORY		
LPG jets	mbar	28-30 / 37
OPTIONAL ACCESSORY		
Wireless Meatprobe		Z1365WX0

	60CM	
	T26CIP8N0 STAINLESS STEEL T26CIP8S0 BLACK N70	
	<ul style="list-style-type: none"> • Stainless Steel / Black • 4 burner • Cast iron supports • Flame Select® • Easy Clean • Biomethane Ready 	
Control position	Front	
Dial Type	Detachable metallic	
Hob surface type	Metal	
KEY FEATURES		
Flame Select®	•	
Digital power level display		
Number of dual circuit wok style burners		
High power (5.0kW+) wok burner		
Dual control wok burner		
FEATURES		
Number of cooking zones	4	
Individual power levels	9	
Variable power levels		
Ignition via control dials	•	
Flame failure safety device	•	
Cast iron pan supports (number)	2	
Cast iron finish pan supports (number)		
Pan Supports Dishwasher safe	•	
PERFORMANCE / TECHNICAL INFORMATION		
Nominal voltage	V	
Maximum gas power output load	W	
Total connected electrical load	max. W	
Cable length	cm	
Plug&Play with GB plug		
Left burner power	kW	
Front left burner power	kW	
Back left burner power	kW	
Centre/Centre front burner power	kW	
Centre back burner power	kW	
Front right burner power	kW	
Back right burner power	kW	
Right burner power	kW	
Pre-set for natural gas		
CE Marked		
STANDARD ACCESSORY		
LPG jets	mbar	
OPTIONAL ACCESSORY		
Wireless Meatprobe		

All models comply with COMMISSION REGULATION (EC) No 1275/2008 with regard to ecodesign requirements for standby and off mode electric power consumption. 14.6kW power output (20A); Current management options for 16A, 13A or 10A connection. *MasterPartner® and AAR product only.

Gas Hobs

		60CM	
		T26GKH8N0 N50	T26NKP4S0 N50
		<ul style="list-style-type: none"> Stainless Steel 4 burner 3.3kW Wok Burner Cast iron supports <ul style="list-style-type: none"> Easy Clean Biomethane Ready 	<ul style="list-style-type: none"> Black Tempered Glass 4 burner <ul style="list-style-type: none"> Cast iron supports Easy Clean Biomethane Ready
			
Control position		Front	Front
Dial Type		Plastic	Plastic
Hob surface type		Metal	Tempered glass
KEY FEATURES			
Flame Select®			
Digital power level display			
Number of dual circuit wok style burners		1	
High power (5.0kW+) wok burner			
Dual control wok burner		•	
FEATURES			
Number of cooking zones		4	4
Individual power levels			
Variable power levels		•	•
Ignition via control dials		•	•
Flame failure safety device		•	•
Cast iron pan supports (number)		2	4
Cast iron finish pan supports (number)			
Pan Supports Dishwasher safe		•	•
PERFORMANCE / TECHNICAL INFORMATION			
Nominal voltage	V	220-240	220-240
Maximum gas power output load	W	7,800	7,500
Total connected electrical load	max. W	1.10	1.10
Cable length	cm	100	100
Plug&Play with GB plug			
Left burner power	kW		
Front left burner power	kW	1.75	1.75
Back left burner power	kW	1.75	1.75
Centre/Centre front burner power	kW		
Centre back burner power	kW		
Front right burner power	kW	1.00	1.00
Back right burner power	kW	3.30	3.00
Right burner power	kW		
Pre-set for natural gas		•	•
CE Marked		•	•
STANDARD ACCESSORY			
LPG jets	mbar	28-30 / 37	28-30 / 37
OPTIONAL ACCESSORY			
Wireless Meatprobe		Z1365WX0	Z1365WX0

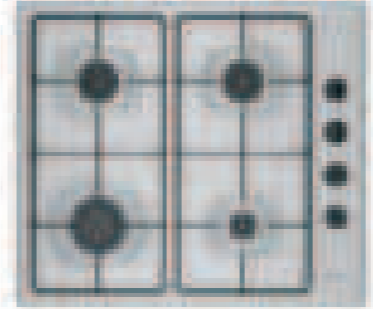
		60CM	
		T26BKP6N0 N30	
		<ul style="list-style-type: none"> Stainless steel 4 burner <ul style="list-style-type: none"> Cast Iron Finish Side controls Easy Clean Biomethane Ready 	
			
Control position		Right Side	
Dial Type		Plastic	
Hob surface type		Metal	
KEY FEATURES			
Flame Select®			
Digital power level display			
Number of dual circuit wok style burners			
High power (5.0kW+) wok burner			
Dual control wok burner			
FEATURES			
Number of cooking zones		4	
Individual power levels			
Variable power levels		•	
Ignition via control dials		•	
Flame failure safety device		•	
Cast iron pan supports (number)		2	
Cast iron finish pan supports (number)			
Pan Supports Dishwasher safe			
PERFORMANCE / TECHNICAL INFORMATION			
Nominal voltage	V	220-240	220-240
Maximum gas power output load	W	7,500	7,500
Total connected electrical load	max. W	1.1	1.1
Cable length	cm	100	100
Plug&Play with GB plug			
Left burner power	kW		
Front left burner power	kW		
Back left burner power	kW		
Centre/Centre front burner power	kW		
Centre back burner power	kW		
Front right burner power	kW	1.00	1.00
Back right burner power	kW	1.75	1.75
Right burner power	kW		
Pre-set for natural gas		•	
CE Marked		•	
STANDARD ACCESSORY			
LPG jets	mbar	28-30/37mbar	28-30/37mbar
OPTIONAL ACCESSORY			
Wireless Meatprobe		Z1365WX0	Z1365WX0

Gas Hobs

90CM
T29RHS4S0

1. Hob top
2. Control panel
3. Burner assembly

75CM
T27PIQ4S0

1. Hob top
2. Control panel
3. Burner assembly

60CM
T26PIP4S0

1. Hob top
2. Control panel
3. Burner assembly

90CM
T29CIR8N0

1. Hob top
2. Control panel
3. Burner assembly

75CM
T27CIQ8N0,
T27CIS8N0,
T27CIQ8S0

1. Hob top
2. Control panel
3. Burner assembly

60CM
T26CIH8N0,
T26CIP8N0,
T26CIP8S0,
T26GKH8N0

1. Hob top
2. Control panel
3. Burner assembly

60CM
T26NKP4S0

1. Hob top
2. Control panel
3. Burner assembly

60CM
T26BKP6N0

1. Hob top
2. Control panel
3. Burner assembly

Flex Design Hobs

FLEX DESIGN

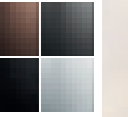

Venting Hobs

Hob Width Size	Collection	Venting Hob	Colour	NEFF Home Connect	Model Code
80cm	N 90	2 x Flex Induction, Extended Frying Sensor, Twist Pad Flex® Control	Black Glass	Yes	V68YYX4C0
80cm	N 90	2 x Flex Induction, Extended Frying Sensor, Twist Pad Flex® Control	Matt Black	Yes	V68YYX4B0
80cm	N 70	2 x Combi Zone, Extended Frying Sensor, Twist Touch® control	Black Glass	Yes	V58YHQ4C0
70cm	N 70	2 x Combi Zone, Extended Frying Sensor, Twist Touch® control	Black Glass	Yes	V57YHQ4C0

Flex Induction Hobs

Hob Width Size	Collection	Flex Design Flex Induction Hob - All with Twist Pad Flex® Control	Colour	NEFF Home Connect	Model Code
90cm	N 90	3 x Flex Zones, Frying Sensor	Black Glass	Yes	T69YYX4C0
90cm	N 90	2 x Flex + 32cm Triple Zone, Frying Sensor	Black Glass	Yes	T69YYV4C0
80cm	N 90	2 x Extended Flex, Frying Sensor	Black Glass	Yes	T68YYY4C0
60cm	N 90	2 x Extended Flex, Frying Sensor	Black Glass	Yes	T66YYY4C0

Colour Coordinated Flex Design Side Trims and Handles

Pack Contents	Anthracite Grey	Brushed Bronze	Deep Black	Metallic Silver
Colour coordinated Twist Pad Flex® - required for Flex Design Induction hobs	Z9801TWAY0	Z9801TWBY0	Z9801TWDY0	Z9801TWMY0
2 x colour coordinated Flex Design Side Trims required for use with all Flex design Induction hobs including Venting Hob	Z9802PFAY0	Z9802PFBY0	Z9802PFDY0	Z9802PFMY0

Electric Hobs

Venting Hobs

Width	Series	Description	Control Type	NEFF Home Connect	Colour	Model Number
80cm	N 90	2 x Flex + Ventilation, Climate Control Sensor, Extended Frying Sensor	Twist Pad®	✓	Black Anthracite Grey Side Trims	V68FUX4L0
80cm	N 70	2 x Combi Zone, Extended Frying Sensor	Twist Touch®	✓	Flush Black Glass	V58PHQ4C0
80cm	N 70	2 x Combi Zone, Extended Frying Sensor	Twist Touch®	✓	Black Glass	V58NHQ4L0
80cm	N 50	1 x Combi Zone	Touch Control		Black Glass	V58NBS1L0
70cm	N 70	2 x Combi Zone, Extended Frying Sensor	Twist Touch®		Black/Stainless steel Side Trims	V57THQ4L0
60cm	N 50	1 x Combi Zone	Touch Control		Black Glass	V56NBS1L0

Flex Induction Hobs

Width	Series	Description	Control Type	NEFF Home Connect	Colour	Model Number
90cm	N 90	2xFlex + 32cm triple zone, Hob-Hood Control, Smart Hood Automatic	Twist Pad®	✓	Black Glass	T69FUV4L0
90cm	N 70	2xFlex + 32cm triple zone, Hob-Hood Control, Smart Hood Automatic, Extended Frying Sensor	Twist Touch®	✓	Black Glass	T69FHV4L0
80cm	N 90	1xFlex + 3 zones, Hob-Hood Control, Smart Hood Automatic	Twist Pad®	✓	Matt Black	T68NUV4A0
80cm	N 90	1xFlex + 3 zones, Hob-Hood Control, Smart Hood Automatic	Twist Pad®	✓	Black Glass	T68FUV4L0
80cm	N 70	1xFlex + 3 zones, Hob-Hood Control, Smart Hood Automatic, Extended Frying Sensor	Twist Touch®	✓	Black Glass	T68FHV4L0
60cm	N70	2xFlex, Hob-Hood Control, Smart Hood Automatic, Extended Frying Sensor	Twist Pad	✓	Matt Black	T66NUX4A0
60cm	N 70	2xFlex, Hob-Hood Control, Smart Hood Automatic, Extended Frying Sensor	Twist Touch®	✓	Black Glass	T66FHX4L0
60cm	N 70	1xFlex + 2 zones, Hob-Hood Control, Smart Hood Automatic, Extended Frying Sensor	Twist Touch®	✓	Black Glass	T66FHE4L0

Induction Hobs

Width	Series	Description	Control Type	NEFF Home Connect	Colour	Model Number
80cm	N 70	CombiZone 5 Zones - 17 power levels, Hob-Hood Control	Twist Touch®	✓	Flush Black Glass	T58PHW1L0
80cm	N 70	CombiZone 5 Zones - 17 power levels, Hob-Hood Control	Twist Touch®	✓	Black Glass	T58FHW1L0
60cm	N 70	CombiZone 4 Zones - 17 power levels, Hob-Hood Control	Twist Touch®	✓	Black Glass	T56FHS1L0
60cm	N 30	4 zones	Touch Control		Black Glass	T36FBE1L0
60cm	N 30	4 zones, Plug & Play with GB Plug	Touch Control		Black Glass	T36FBE1LOG
60cm	N 30	9 Power levels, 4 zones, Plug & Play with GB Plug	Touch Control		Black Glass	T36CA50X1U

Quick-Light Ceramic Hobs

Width	Series	Description	Control Type	NEFF Home Connect	Colour	Model Number
60cm	N 50	4 zones, 17 power levels	Touch Control		Black Glass	T16NBE1L

Gas Hobs

Width	Series	Description	Control Type	NEFF Home Connect	Colour
90cm	N 90	Black Tempered Glass, 5.0kW Wok Burner, Illuminated Removable Metallic Dials, Hob-Hood Control, Smart Hood Automatic, Touch Control, Dishwasher Safe Pan Supports	Flame Select®	✓	Black Tempered Glass/Black Cast Iron Supports
90cm	N 70	5 burner, 5.0kW Wok Burner, Star Layout, Illuminated Removable Metallic Dials, Dishwasher Safe Pan Supports	Flame Select®		Stainless steel/Black Cast Iron Supports
75cm	N 70	Black Tempered Glass, 5 Burner, 4.0kW Wok Burner, Star Layout, Illuminated Removable Metallic Dials, Dishwasher Safe Pan Supports	Flame Select®		Black Tempered Glass/Black Cast Iron Supports
75cm	N 70	5 burner, 4.0kW Wok Burner, Star Layout, Comfort Clean, Illuminated Removable Metallic Dials, Dishwasher Safe Pan Supports	Flame Select®		Stainless steel/Black Cast Iron Supports
75cm	N 70	5 burner, 5.0kW Wok Burner, Flag Layout, Illuminated Removable Metallic Dials, Dishwasher Safe Pan Supports,	Flame Select®		Stainless steel/Black Cast Iron Supports
75cm	N 70	5 burner, 4.0kW Wok Burner, Star Layout, Illuminated Removable Metallic Dials, Dishwasher Safe Pan Supports,	Flame Select®		Black Enamel Surface/Black Cast Iron Supports
60cm	N 70	Black Tempered Glass, 4 Burner, Illuminated Removable Metallic Dials, Dishwasher Safe Pan Supports,	Flame Select®		Black Tempered Glass/Black Cast Iron Supports
60cm	N 70	4 Burner, 3.5kW Wok Burner, Illuminated Removable Metallic Dials, Dishwasher Safe Pan Supports,	Flame Select®		Stainless steel/Black Cast Iron Supports
60cm	N 70	4 Burner, Illuminated Removable Metallic Dials, Dishwasher Safe Pan Supports,	Flame Select®		Stainless steel/Black Cast Iron Supports
60cm	N 70	4 Burner, Illuminated Removable Metallic Dials, Dishwasher Safe Pan Supports,	Flame Select®		Black Enamel surface/Black Cast Iron Supports
60cm	N 50	4 Burner, 3.3kW Wok Burner, Dishwasher Safe Pan Supports			Stainless steel/Black Cast Iron Supports
60cm	N 50	Black Tempered Glass, 4 Burner, Dishwasher Safe Pan Supports			Black Tempered Glass/Black Cast Iron Supports
60cm	N 30	4 Burner, Lateral Dials			Stainless steel/Black Cast Iron Finish Supports

NEFF VENTILATION Range

Ventilation is a key consideration in every kitchen; the Hob and Hood are a focal point of all cooking setups. The kitchen design and layout will dictate the Ventilation solution that is perfect for your kitchen.

NEFF have a clear and comprehensive range that can be installed in every kitchen.

Why NEFF Ventilation?

Performance – NEFF focus on extraction performance and have options to suit all kitchen styles. Depending on whether using induction or gas there is an option for every hob.

Design – this is as important as Performance in a kitchen as the style of the hood needs to match the style and aesthetics in the kitchen – NEFF have a broad range of hoods that can be the focal point of the kitchen or installed neatly in furniture.

Connected – NEFF Home Connect allows your hood to be controlled by your smartphone or voice assistant, making the cooking experience easier. Features such as Climate Control & Hob-Hood Control are further options for easy use of the Hood.

Installation – all NEFF hoods have been designed with the installation front of mind. With ducting and filters to match the installation solution – it's easy to navigate the range and order the appropriate kit. There are also installation videos to assist.

Introducing the new generation of NEFF Hoods

Our next-generation Integrated Design and Box Hoods combine stunning style with superb performance. Whether you want a striking stand-out feature or a hood that tucks neatly into upper cabinets, these models give you the installation flexibility to match any kitchen aesthetic. Integrated Design Hoods can be installed easily by one person and provide handy storage (supporting 10kg either side), while the Box Hoods deliver a sleek, subtle matt-black chimney and side trim ideal for fitting between cabinets or open shelving.



Your Guide to Control Types



NEFF Home Connect

Compatible with Amazon Alexa and Google Home.

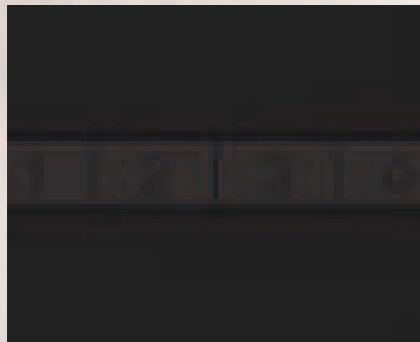

Push Button

Our classic hoods feature simple, sleek and easy to use push button controls. Available across selected models in the N30 Collection.

Rocker or Slider Switch Control

Available on our N30 Telescopic and Canopy models, our rocker or slider switch control offers a simple and straight forward setting navigation that's neatly concealed within the hood furniture.

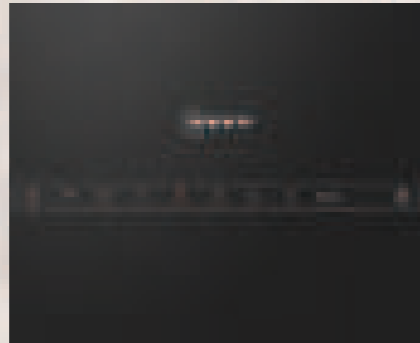

Touch Control

Featured on selected models in the N90, N70 and N50 Collections. Touch Control flawlessly complements our ovens and compact appliances. An LED display is also available with selected Touch Control models.



Remote Control

Available for Ceiling Hood.

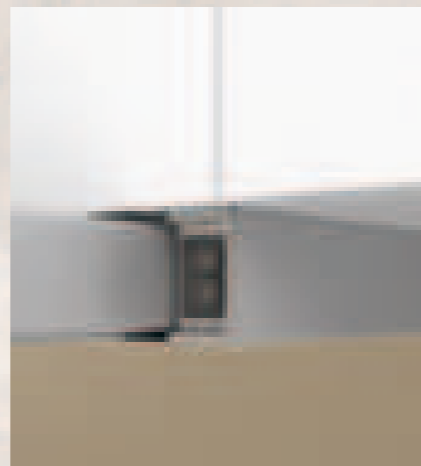
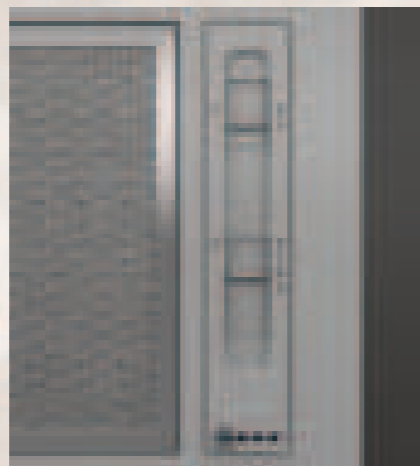

Key Functions Guide

Features



NEFF HOME CONNECT

Control all functions and settings of your hood directly from your smart phone and voice control for the ultimate connected cooking experience.



HOB HOOD CONTROL

The Hob Hood Control allows the hood to be directly controlled from the hob. This means the hood turns on when you start cooking and, in automatic mode, can automatically regulate the power level for the best performance with the lowest noise – it also means you no longer need to worry about adjusting the hood and you can focus on your cooking.



CLIMATE CONTROL

Detects the amount of steam and smells using a sensor attached to the motor and automatically sets the most effective power level to extract it.

AMBIENT LIGHT

Illuminates your kitchen in the light that suits the occasion best. Choose from 31 colours to change how your kitchen looks and, most importantly, how it makes you feel.



SMART HOOD AUTOMATIC

Automates range-hood control via Home Connect: the hob sends data to the hood, which adjusts fan speed and suction for efficient odour and particle removal. It reduces noise and energy use by lowering speed or switching off when the cooktop is idle, giving hands-free, optimised ventilation.



EFFICIENT DRIVE MOTOR

Our Efficient Drive motor brings harmony to the kitchen. It's whisper-quiet and powerful too. Now you can focus on your cooking, and your guests, while your extractor keeps your kitchen calm, clean and serene.



NEFF SILENCE BUTTON

The unique noise reduction function reduces the fan noise by a couple of decibels, ensuring that the kitchen stays quiet while you cook and entertain your guests. This function can be used at any fan setting except fan setting 1.

SATURATION INDICATORS

Take the stress out of guessing, this function will prompt you if the grease filters should be cleaned. If the hood is installed in recirculation, this will also indicate when the charcoal filters need replacing.

BOOST POSITION

For our sleek angled glass and flat hoods, receive an extra boost of extraction performance in special cooking situations, for example when frying meat or fish. The front panel can be slightly opened during cooking to a defined extraction boost position in order to increase the steam catching rate of the hood and keep your kitchen free from steam.

Functions

AUTOMATIC AFTER-RUNNING

Continues running at a low speed for 3-30 minutes before turning itself off. Perfect for keeping fresh air in the kitchen post-cooking.

INTENSIVE SETTING

Boosts the extraction rate to the maximum level to cope with particularly demanding cooking conditions.

ELECTRONIC POWER LEVEL DISPLAY

The sleek display clearly shows the selected fan power level setting.

NEFF FRESH AIR

Runs an automatic air exchange programme, turning the hood into power level 1 for 5 minutes every hour for as long as required.

AUTOMATIC REVERT

Automatically reverts the hood back to a lower power level after approximately ten minutes of being on the intensive setting.

SOFT LIGHT

Brightens or dims the lights as it's switched on or off; just press and hold to adjust the level of brightness.

Installation Options

The best way to remove steam and odours is to extract the air out of the room through ducting. Unfortunately, in apartments or where the hood is too far away from an outside wall, this may not be possible. In this case, the only alternative is to recirculate the air. Stale air is sucked through a grease filter, before being purified in a charcoal filter, and then pumped back into the kitchen via an opening in the hood.

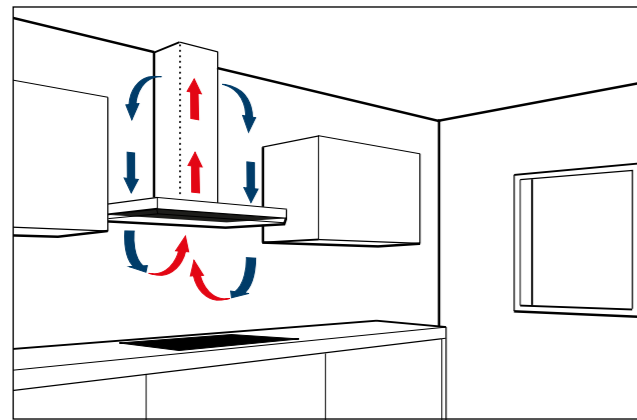

Recirculation

Recirculating

Removes between 70-95% of odours depending on filter used. Requires changing of charcoal filter on a regular basis or a longer-lasting Regenerative filter for certain models can be used.

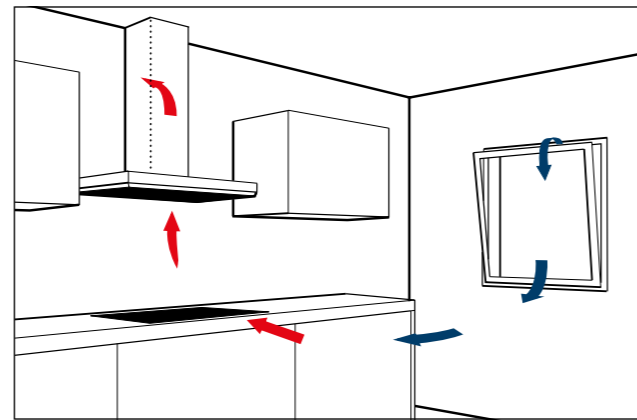

Extraction

Ducted

Removes up to 98% of odours in an optimal installation. Requires planning of ducting (ducting to be sourced separately), however doesn't require a recirculation charcoal filter.

Use the following equation to calculate your extraction rate:

Volume of kitchen (length x width x height) eg. 4m x 3m x 2.5m = 30m³

6 x volume in normal operation and 12 x volume in intensive operation.

Please note that these are recommended estimates only to be used as a guide. This assumes a 2.5m standard ceiling height with 12 air changes per hour to match to an intensive extraction rate.

Regenerative Recirculation Filters

The new Regenerative Charcoal Filters give you a long lasting filter, thanks to a regenerative process using your oven, and can even be installed without a chimney piece if preferred. Benefit from up to 95% odour reduction when in recirculation mode.





Identify your extraction rate

Your extractor needs to circulate the air in the room 6 times in normal operation, 12 times in intensive operation, per hour. Use the below to help identify the required extraction rate which can then be used to select the appropriate extractor.

	2.5m	3m	3.5m	4m	4.5m	5m
2.5m	16m ³					
3m	19m ³	23m ³				
3.5m	22m ³	26m ³	31m ³			
4m	25m ³	30m ³	35m ³	40m ³		
4.5m	28m ³	34m ³	39m ³	45m ³	51m ³	
5m	31m ³	38m ³	44m ³	50m ³	56m ³	63m ³

Recirculation Filters

We offer a range of recirculation filters that are available depending on the model of hood you choose. Featuring powerful odour reduction rates and performance benefits, our new regenerative filters can last up to 10 years and are regenerated through a heating process in the oven every 4 months.

TYPE	Standard Odour Filter	Cleanair Plus Filter	Long-life CleanAir Filter	Long Life Regenerative Filter
				
ODOUR REDUCTION	Up to 85%	> 90%	> 90%	> 80%
RECOMMENDED EXCHANGE	Approx. 2 times per year	Approx. once per year	Approx. once every 4 years	Approx. once every 10 years
KEY BENEFITS	<ul style="list-style-type: none"> Simple installation Anti-fish treatment 	<ul style="list-style-type: none"> Up to 3dB (A) sound reduction Better extraction performance Anti-fish treatment Removes over 99% of all pollen 	<ul style="list-style-type: none"> Up to 3dB (A) sound reduction Better extraction performance Anti-fish treatment Removes over 99% of all pollen Oven Heating – 3 Hours 100°C regenerates filter for 12 months – can be done up to 3 times. 	<ul style="list-style-type: none"> Up to 3dB (A) sound reduction Regenerated in the oven every 4 months recommended (2 hours 200°C) Better extraction performance

The filters within the table are not necessarily compatible with all Hoods. In some instances, an additional module may be required to house the filter. Images for example only, filters may come in different sizes/styles.

Installation

The following points should be observed for optimum ducted extraction results and low noise:

1. Ensure any pipe elbow bends are at least 30cm from the hood ducting opening.
2. Avoid reducing the diameter or area of the ducting.
3. Use wide-angled pipe elbows, but keep the number used to a minimum.
4. Only install pipes with smooth, even inner surfaces. If a flexible hose has to be used, ensure it is pulled tight to smooth out the ridges before fixing.
5. Use ducting pipes with a diameter of at least 120mm, but ideally 150mm.
6. Keep piping to a minimum – use the most direct route to an external outlet.
7. Make sure that there is an adequate supply of fresh air to replace the air ducting out of the kitchen, i.e. windows that can be opened, doors to adjacent rooms, air bricks. Problems with installation may occur if points 1-7 are not observed.

Easy Mounting System

Thanks to an easy wall-mounting system, selected hoods can be installed quickly and securely by one person. Rotating offset 'cam' fixings make it possible for positional adjustments of up to 6mm, helping to get the hood level and stable. (Not available on all our hoods.)

Effortless Compatibility: Experience

NEFF's Hob Hood Connectivity

NEFF offers two systems for automatic control of your hood: Smart Hood Automatic and climateControl sensor.

These systems simplify hood control, allowing you to focus on cooking without the need to reach up to the hood. It's advisable that you choose the same width for your hob & your hood.

HOODS	VALUE CLASS	DESIGN / RANGE	90CM RANGE	
			Model	Image
CLIMATECONTROL SENSOR HOODS Hoods equipped with our climateControl sensor work with any hob. The intelligent sensor detects smells and steam before adjusting the Hood's fan speed levels accordingly.	N90	Flex Design	I98WMM1Y7B Glass Draft Hood	
		Core Range	I98WMM1S7B Glass Draft Hood	
		Flex Design	D98IPT2Y5 Wall Mounted Angled Hood	
		Core Range	D98IPT2S0B Wall Mounted Angled Hood	
SMART HOOD AUTOMATIC Smart Hood Automatic by NEFF improves hood functionality with intelligent automation. The NEFF Home Connect compatible hob will share output data with the hood which will then automatically adjust its fan speed and suction power. This ensures efficient removal of odours and airborne particles. The system prioritises energy efficiency while minimizing noise levels by reducing speed or powering off when the cooktop is not in use. Smart Hood Automatic enhances the cooking experience by eliminating the need for manual adjustments and providing hassle-free ventilation. It represents an innovative solution for optimizing range hood performance and user comfort.	N90	Core Range	D98XET2S0B Integrated Design Hood	
	N70	Core Range	D97BDN2S0B Wall Mounted Box Hood	
	N50	Core Range		

80CM RANGE		60CM RANGE	
Model	Image	Model	Image
I88WMM1Y7B Glass Draft Hood			
I88WMM1S7B Glass Draft Hood			
D88XET2S0B Integrated Design Hood		D68XET2S0B Integrated Design Hood	
D88IAN2S0B Wall Mounted Angled Hood		D67BDN2S0B Wall Mounted Box Hood	
D85IFN1S0B Wall Mounted Angled Hood		D65IFN1S0B Wall Mounted Angled Hood	



Compatible Hobs

Smart Hood Automatic requires a compatible NEFF hob and the NEFF Home Connect app. Using intelligent algorithm technology, the Hood will adjust its fan speed level based on the Hob's output. Within the range of Home Connect enabled hoods in the NEFF Range of N90 & N70 hoods these will compatible with the hood range above.



Glass Draft Hoods Flex Design

Seamless Hob Installation

Celebrate your kitchen design with visual unity. Our Glass Draft Hood has been designed to be installed seamlessly with any of our Flex Design hobs in the corresponding 90cm or 80cm width.

Ambient Light

The passionate cook's perfect must-have. Our Glass Panel with Illumination is unobtrusive so it will never divert attention from the peaceful view into your open plan kitchen or living area. Connect your Glass Draft Hood with the NEFF Home Connect app and choose from endless colours for the edge of your Glass Panel. Then treat yourself to a unique cooking experience every time with your choice of individual lighting.



Open for fresh designs

Within the Flex Design Range NEFF offers two Glass Draft Hoods and one Angled Hood in the range. These are quite straightforward in ordering the trims as they are a standard size for the appliance. The exception is where the Glass Draft is to be installed seamlessly with the relevant Flex Induction Flex Design Hob - the details are included in the next section.

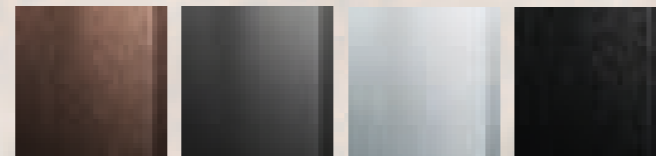

Brushed Bronze Anthracite Grey Metallic Silver Deep Black

Personalise your hob and hood with easily interchangeable Flex Design Trim, available in four distinctive colours, to coordinate with your oven, coffee machine and your Twist Pad Flex®.



Your Guide To Single Appliance Flex Design



Glass Draft Hoods

Flex Design pack includes Side Trims for Glass Draft Hoods.

STEP 1 CHOOSE YOUR GLASS DRAFT HOOD				STEP 2 CHOOSE YOUR FLEX DESIGN TRIM		STEP 3 COMPLETED APPLIANCE
Collection	Size	Hood Type	Model Number	Finish	Model Number	
N90	90cm	Guided Air technology, Automatic Air Sensor, Clear Glass with Ambient Light	I98WMM1Y7B	Anthracite Grey	Z5802GLAY0	 Model shown: I98WMM1Y7B Glass Draft Hood Z5802GLBY0 Flex Design Trim
	80cm	Guided Air technology, Automatic Air Sensor, Clear Glass with Ambient Light	I88WMM1Y7B	Brushed Bronze	Z5802GLBY0	
N90	80cm	Guided Air technology, Automatic Air Sensor, Clear Glass with Ambient Light	I88WMM1Y7B	Deep Black	Z5802GLDY0	
				Metallic Silver	Z5802GLMY0	



THE NEFF OVEN COLLECTIONS

HOB

VENTILATION

Your Guide To Seamless Combination Flex Design

Side Trim – Induction Hob and Glass Draft Hood

Induction Hob installed with Glass Draft Hood with Seamless Combination trim.

STEP 1 CHOOSE YOUR COMPLETED COMBINATION		STEP 2 SUITABLE APPLIANCES		STEP 3 CHOOSE YOUR FLEX DESIGN TRIM		STEP 4 CHOOSE YOUR FINISH		SUMMARY ORDER...		
 90cm HOB		CHOOSE YOUR INDUCTION HOB*		CHOOSE YOUR GLASS DRAFT HOOD*		CHOOSE YOUR FLEX DESIGN TRIM		CHOOSE YOUR FINISH		
		Collection	Size	Hob Type	Model Number	Collection	Size	Hood Type	Model Number	
		N90	90cm	3 Flex zones, frying sensor.	T69YYX4C0	N90	90cm	Guided Air technology, Automatic Air Sensor, Clear Glass with Ambient Light	I98WMM1Y7B	
		N90	90cm	2 Flex zones, 32cm triple zone, frying sensor.	T69YYV4C0	N90	80cm	Guided Air technology, Automatic Air Sensor, Clear Glass with Ambient Light	I88WMM1Y7B	
		N90	80cm	2 extended flex, frying sensor.	T68YYY4C0					
						Finish		Model Number		
						Anthracite Grey		Z9302GLAY0	Anthracite Grey	Z9801TWAY0
						Brushed Bronze		Z9302GLBY0	Brushed Bronze	Z9801TWBY0
						Deep Black		Z9302GLDY0	Deep Black	Z9801TWDY0
						Metallic Silver		Z9302GLMY0	Metallic Silver	Z9801TWMY0
						PLUS REQUIRED INSTALLATION ACCESSORY				
						SITS BENEATH APERTURE TO SUPPORT HOB AND HOOD PRODUCTS				
						90cm Installation Accessory		Z92WWY9X2		
						80cm Installation Accessory		Z92WWY8X2		
						To install a 90cm Induction Hob and 90cm Glass Draft Hood in Brushed Bronze. T69YYX4C0 Induction Hob I98WMM1Y7B Glass Draft Hood Z9302GLBY0 Flex Design Trim Z92WWY9X2 Required Installation Accessory Z9801TWBY0 Twist Pad Flex®				

*Please note you can combine 90cm Hob and Hood or 80cm hob and hood.

REFRIGERATION

DISHWASHING

LAUNDRY

Island Ventilation Solutions

Open plan kitchens are growing in popularity and these solutions can create that open plan aesthetic.



Glass Draft Hood

- Modern version of a downdraft hood is a highly effective worktop ventilation solution that vanishes completely when not in use.
- A unique solution with impressive design and performance credentials.
- Guided Air technology has an additional motor with a fan that creates a “V” shaped curtain of air behind the screen – pushing down cooking vapours which are captured by the extractor fan.
- Fully Automated Extraction – using climateControl sensor to detect the amount of humidity and grease in the air – automatically adjusting to the correct level.
- Ambient lighting – using the NEFF Home Connect app the colours can be changed to suit the room or the vibe in the kitchen.



Venting Hob

- Designed with open plan living in mind – Extremely silent powerful ventilation.
- Generous glass surface area with a slim integrated vent creates a flexible work surface which is simple to clean.
- Easy to remove Grease filter can hold spillages of up to 200ml.
- Grease filter and holder and dishwasher safe for easy & effective cleaning.
- Flex Induction & Combi Zone models available.
- Choice of Controls – Twist Pad® or Touch Twist®.
- Available in Black Glass or new Matt Black finish in Flex Design Range.

Seamless Hob Installation

- To create a unified hob and hood installation the Glass Draft Hood can be combined with selected Induction hobs.
- Available for both 90cm and 80cm widths.



Ceiling Hood

- Designed for modern island and peninsula kitchen layouts.
- Provide high performance with low noise levels.
- Easy adjustable installation for different thickness of ceiling material and construction.
- Flush mounted.
- Can be used in extraction or recirculation mode.
- 360° turntable motor – easy access for ducting and power connection once installed.
- Can be used with Clean Air or Regenerative filters.



FLEX DESIGN
**Flex Design
 Glass Draft
 Hoods**

• Installation can be Recirculated or Ducted out.



SPECIAL FEATURES	90CM I98WMM1Y7B N90	80CM I88WMM1Y7B N90
Seamless Installation to Hob Available (Check Compatibility)	•	•
NEFF Home Connect	•	•
Guided Air	•	•
Ambient Light	•	•
Climate Control Sensor	•	•
Hob-hood control	•	•
Efficient Drive	•	•
Intensive setting / Automatic intensive revert ¹	•	•
Filter Saturation Indicator	•	•
Filter Service Position	•	•
FEATURES		
Suitable for ducted operation / recirculating ²	•	•
Power levels	3 + 2 Intensive	3 + 2 Intensive
NEFF Fresh Air (Interval operation)	•	•
Automatic after running min	10	10
Lighting	Glass rim illumination	Glass rim illumination
Type of control	Touch Control	Touch Control
PERFORMANCE / TECHNICAL INFORMATION		
Energy Rating	A	A
Appliance width mm	918	802
Extraction Rate in m³/h^{3,4}		
Power level 3 - ducted / recirculating	519 / 472	501 / 447
Intensive level 1 - ducted / recirculating	656 / 543	620 / 501
Intensive level 2 - ducted / recirculating	833 / 620	775 / 562
Noise level (sound power) based on dB(A) re 1 pW^{3,5}		
Power level 3 - ducted / recirculating	62 / 65	62 / 65
Intensive level 1 - ducted / recirculating	67 / 68	67 / 67
Intensive level 2 - ducted / recirculating	71 / 71	70 / 70
Pipe outlet diameter mm	150	150
Minimum distance above an electric hob / gas hob ⁶ mm	0 / Not Compatible	0 / Not Compatible
GB plug	•	•

Flex Design Trim

Finish	Model Number
Anthracite Grey	Z90802PFAY0
Brushed Bronze	Z90802PFBY0
Deep Black	Z90802PFDY0
Metallic Silver	Z90802PFMY0

FLEX DESIGN
**Flex Design
 Angled
 Hood**





Flex Design Trim	Model Number
Anthracite Grey	Z91BIE9AY0
Brushed Bronze	Z91BIE9BY0
Deep Black	Z91BIE9DY0
Metallic Silver	Z91BIE9MY0

SPECIAL FEATURES	90CM D98IPT2Y5 N90
NEFF Home Connect	•
Adjustable LED White Colour Temperature	•
Climate Control Sensor	•
Smart Hood Automatic	•
Hob-hood control	•
Efficient Drive	•
Intensive setting / Automatic intensive revert ¹	• / •
Filter Saturation Indicator	•
FEATURES	
Suitable for ducted operation / recirculating ²	• / •
Electronic power level display	•
Power levels	3 + 2 Intensive
Automatic after running minutes	10
Lighting	2 x LED lights
Type of control	Touch Control
PERFORMANCE / TECHNICAL INFORMATION	
Energy Rating	A+
Appliance width mm	890
Extraction Rate in m³/h^{3,4}	
Power level 3 - ducted / recirculating	441 / 435
Intensive level 1 - ducted / recirculating	753 / 752
Intensive level 2 - ducted / recirculating	1007 / 964
Noise level (sound power) based on dB(A) re 1 pW^{3,5}	
Power level 3 - ducted / recirculating	51 / 59
Intensive level 1 - ducted / recirculating	65 / 72
Intensive level 2 - ducted / recirculating	70 / 78
Pipe outlet diameter mm	150
Minimum distance above an electric hob / gas hob ⁶ mm	450 / 650
GB plug	•

¹Power automatically reverts back to normal setting after intensive. ²A type of recirculating kit is required if recirculating. ³Air Flow and noise declarations made in line with CECEC Code of Conduct. ⁴Measured according to EN61591 on largest pipe diameter. ⁵Sound power measured according to EN60704-3 on largest pipe diameter. ⁶From top of pan supports. Depending on the model, a 'Recirculating odour filter kit' will consist of the following items: Charcoal filter, flexible hose, air duct, fixing components, installation instructions.

Worktop Installation

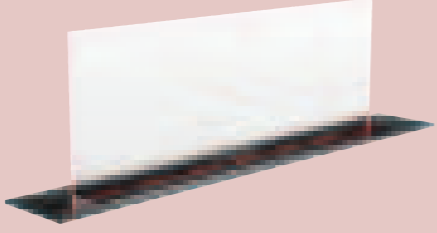
- Installation can be Recirculated or Ducted out.

	90CM I98WMM1S7B N90	80CM I88WMM1S7B N90
	<ul style="list-style-type: none"> • Guided Air Technology • Climate Control Sensor • Hob-Hood Control • Efficient Drive Motor • NEFF Home Connect • Ambient Light 	<ul style="list-style-type: none"> • Guided Air Technology • Climate Control Sensor • Hob-Hood Control • Efficient Drive Motor • NEFF Home Connect • Ambient Light 
	<p>ORDER SEAMLESS COMBINATION</p> <p>Step 1 – Glass Draft Hood Order your glass draft hood. • I98WMM1S7B</p> <p>Step 2 – Induction Hob Order your compatible Induction Hob. • T69FUV4L0 90cm Flex Induction Hob • T69FHV4L0 90cm Flex Induction Hob</p> <p>Step 3 – Seamless Installation Kit Order your Seamless Combination Kit • Z92WWY9X2</p>	<p>ORDER SEAMLESS COMBINATION</p> <p>Step 1 – Glass Draft Hood Order your glass draft hood. • I88WMM1S7B</p> <p>Step 2 – Induction Hob Order your compatible Induction Hob. • T68FUV4L0 80cm Flex Induction Hob • T58FHW1L0 80cm Flex Induction Hob • T68FHV4L0 80cm Flex Induction Hob</p> <p>Step 3 – Seamless Installation Kit Order your Seamless Combination Kit • Z92WWY8X2</p>
SPECIAL FEATURES		
Seamless Installation to Hob Available (Check Compatibility)	•	•
NEFF Home Connect	•	•
Guided Air	•	•
Ambient Light	•	•
Climate Control Sensor	•	•
Hob-hood control	•	•
Efficient Drive	•	•
Intensive setting / Automatic intensive revert ¹	•	•
Filter Saturation Indicator	•	•
Filter Service Position	•	•
FEATURES		
Suitable for ducted operation / recirculating ²	•	•
Power levels	3 + 2 Intensive	3 + 2 Intensive
NEFF Fresh Air (Interval operation)	•	•
Automatic after running	10	10
Lighting	Glass rim illumination	Glass rim illumination
Type of control	Touch Control	Touch Control
PERFORMANCE / TECHNICAL INFORMATION		
Energy Rating	A	A
Appliance width	918	802
Extraction Rate in m³/h^{3,4}		
Power level 3 - ducted / recirculating	519 / 472	501 / 447
Intensive level 1 - ducted / recirculating	656 / 543	620 / 501
Intensive level 2 - ducted / recirculating	833 / 620	775 / 562
Noise level (sound power) based on dB(A) re 1 pW^{3,5}		
Power level 3 - ducted / recirculating	62 / 65	62 / 65
Intensive level 1 - ducted / recirculating	67 / 68	67 / 67
Intensive level 2 - ducted / recirculating	71 / 71	70 / 70
Extension Height	250	250
Pipe outlet diameter	150	150
Minimum distance above an electric hob / gas hob ⁶	0 / Not Compatible	0 / Not Compatible
GB plug	•	•

Ceiling Installation Hoods

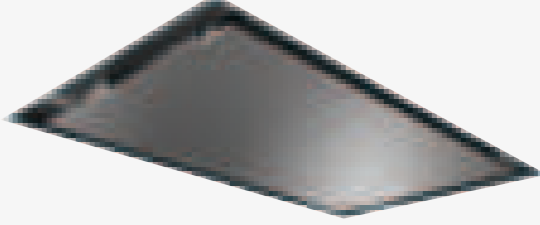
	90CM I95CAQ6N0B N50
	<ul style="list-style-type: none"> • Hob-Hood Control • Efficient Drive Motor • NEFF Home Connect 
SPECIAL FEATURES	
NEFF Home Connect	•
Hob Hood control	•
Efficient Drive	•
Intensive setting / Automatic intensive revert ¹	• / •
NEFF Silence function	•
Filter saturation indicator	•
FEATURES	
Suitable for ducted operation / recirculating	• / •
Power levels	3 + 2 Intensive
NEFF Fresh Air (Interval operation)	•
Automatic after running	10
Lighting	4 x LED lights
Softlight with dimmer function	•
Number of metal grease filter cassettes	2
Type of control	Remote Control
PERFORMANCE / TECHNICAL INFORMATION	
Energy Rating	A
Appliance width	900
Extraction Rate in m³/h^{3,4}	
Power level 3 ducted / recirculating	458 / 422
Intensive level 1 ducted / recirculating	594 / 513
Intensive level 2 ducted / recirculating	798 / 565
Noise level (sound power) based on dB(A) re 1 pW^{3,5}	
Power level 3 ducted / recirculating	56 / 63
Intensive level 1 ducted / recirculating	62 / 67
Intensive level 2 ducted / recirculating	68 / 69
Pipe outlet diameter	150
Minimum distance above an electric hob / gas hob ⁶	650 / 650
GB plug	•

¹Power automatically reverts back to normal setting after intensive. ²A type of recirculating kit is required if recirculating. ³Air Flow and noise declarations made in line with CECEC Code of Conduct. ⁴Measured according to EN61591 on largest pipe diameter. ⁵Sound power measured according to EN60704-3 on largest pipe diameter. ⁶From top of pan supports. Depending on the model, a 'Recirculating odour filter kit' will consist of the following items: Charcoal filter, flexible hose, air duct, fixing components, installation instructions.

Flex Design Venting Hobs



- Twist Pad Flex®
- 2 x Flex Zones
- Climate Control Sensor
- Extended Frying sensor
- Appliance requires Twist Pad Flex® to be ordered in desired trim colour

KEY FEATURES	
Twist Pad Flex® required	•
Integrated extractor	•
Frying Sensor	11 levels
Favourite Button	•
Automatic extraction	Fully sensor based
Number of Flex Induction zones	2
Number of Combi Zone	
HOB FEATURES	
Number of individual zones	4
Power Levels	17
Power Boost	•
Power Transfer	•
Digital display / Adaptable Volume	• / •
Count up Timer / Count down timer / Pause Function	/ • / •
Main on/off switch / Quick Start / Quick Stop/ Restart Function	• / • / •
Pan Recognition / Pan Boost	• / Via HC/Favourite Button
Dish Categories / Setting Recommendations	Via HC
Keep Warm Function	Via HC/Favourite Button
SAFETY FEATURES	
Residual Heat Indicator	•
Control Panel Lock / Safety Time Switch off	• / •
HOOD FEATURES	
Climate Control sensor	•
Power levels	17 + 2 Intensive
Automatic intensive revert setting	6 minutes
Automatic or manual control / Interval operation	• / •
Automatic after running (extraction/recirculation)	12 / 30 minutes
Dishwasher safe grease filter cassette with spillage collection	Yes - 200ml capacity
Dishwasher safe spillage overflow collector	700ml capacity
Metal grease filter / Electronic grease filter / Clean Air filter saturation indicators	• / • / •
PERFORMANCE / TECHNICAL INFORMATION – HOB	
Nominal voltage / Maximum power output	V / W 220-240 / 7,400
Electrical cable length	cm 110
Rear left Induction zone	kW/mm 2.20 200x230
Rear right Induction zone	kW/mm 2.20 200x230
Front left Induction zone	kW/mm 2.20 200x230
Front right Induction zone	kW/mm 2.20 200x230
Flex Induction / Combi Zone zone left	kW/mm 3.30 400x230
Flex Induction / Combi Zone zone right	kW/mm 3.30 400x230
Combi Zone left	kW/mm
Combi Zone right	kW/mm
Rear left / right zone – with Power Boost	max. kW 3.70 / 3.70
Front left / right zone – with Power Boost	max. kW 3.70 / 3.70
PERFORMANCE / TECHNICAL INFORMATION – EXTRACTOR	
Extractor energy efficiency rating	A B
Extraction Rate in m³/h¹²	
Ducted / Recirculating power level Minimum	154 / 132
Ducted / Recirculating power level Maximum	500 / 499
Ducted / Recirculating power level Intensive	622 / 595
Noise level (sound power) based on dB(A) re 1 pW¹³	
Ducted / Recirculating power level Minimum	42 / 41
Ducted / Recirculating power level Maximum	69 / 68
Ducted / Recirculating power level Intensive	74 / 72
Motor power	170



- Twist Touch® Control
- 2 x Combi Zone
- Auto-On Fan
- Extended Frying Sensor

	•
	11 levels
	•
	Auto-On
	2: Left & Right
	4
	17
	•
	• / •
	/ • / •
	• / • / •
	• / Via HC/Favourite Button
	Via HC/Favourite Button
	•
	• / •
	9 + 2 Intensive
	6 minutes
	• / •
	30 minutes
	Yes - 200ml capacity
	700ml capacity
	• / • / •
	220-240 / 7,400
	110
	2.50 190x210
	2.50 190x210
	2.50 190x210
	2.50 190x210
	3.60 380x210
	3.60 380x210
	3.70 / 3.70
	3.70 / 3.70
	A B
	154 / 117
	500 / 487
	622 / 595
	42 / 41
	69 / 68
	74 / 72
	170

Flex Design Trim

All Flex Design Venting Hobs require a set of Flex Design side trims to be ordered. All trims are a standard size and available in all 4 colours.

Finish	Model Number
Anthracite Grey	Z90802PFAY0
Brushed Bronze	Z90802PFBY0
Deep Black	Z90802PFDY0
Metallic Silver	Z90802PFMY0

Twist Pad Flex®

To complete the Hob the choice of Twist Pad Flex® also needs to be ordered. Choose a side trim and Twist Pad Flex® in the desired colour.

Finish	Model Number
Anthracite Grey	Z9801TWAY0
Brushed Bronze	Z9801TWBY0
Deep Black	Z9801TWDY0
Metallic Silver	Z9801TWMY0

¹ Air flow and noise declarations made in line with CECEC Code Of Conduct. ² Measured according to EN61591 on largest pipe diameter. ³ Sound power measured according to EN60704-3 on largest pipe diameter.

Venting Hobs

- Installed with energy efficient brushless motors that offer powerful but quiet performance.
- Can be installed in Recirculation or Ducted Out – 4 Ventilation solutions available.
- A larger Overflow container will hold up to 700ml and is integrated in the base of the appliance so will not impact on storage space below.
- To install in re-circulation mode no further components are required.

80CM

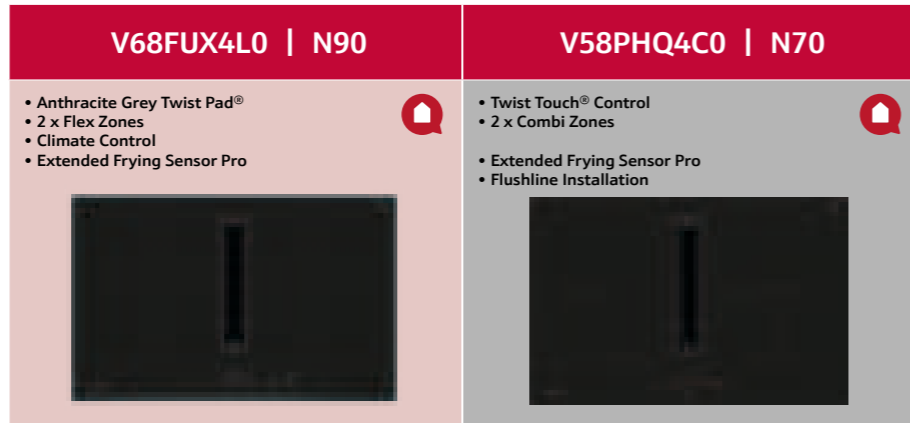

KEY FEATURES		V68FUX4L0 N90	V58PHQ4C0 N70
NEFF Home Connect		•	•
Integrated extractor		•	•
Automatic extraction		Fully sensor based	Auto-On
Favourite Button		•	•
Extended Frying Sensor		11 settings	11 settings
Power Move / Power Boost / Power Transfer		/ ● / ●	/ ● /
Flex Induction		•	•
Number of Flex Induction zones		2	•
Combi Zone Induction		•	2: Left & Right
HOB FEATURES			
Number of individual zones		4	4
Power Levels		17	17
Digital display / Adaptable Volume		● / ●	● / ●
Count up Timer / Count down timer		/ ●	/ ●
Main on/off switch / Quick Start / Restart Function / Quick Stop		● / ● / ● /	● / ● / ● /
Energy Consumption Display		•	•
Pan Recognition / Pan Boost		• /	• /
Demo Mode		•	•
Dish Categories / Setting Recommendations		Via HC	Via HC
Keep Warm Function		Via HC / Favourite Button	Via HC / Favourite Button
SAFETY FEATURES			
Residual Heat Indicator / Pause Function		● / ●	● / ●
Timer with automatic switch off for each zone		•	•
Control Panel Lock / Safety Time Switch off		● / ●	● / ●
HOOD FEATURES			
Climate Control sensor		•	•
Power levels		17 + 2 Intensive	9 + 2 Intensive
Automatic intensive revert setting		6 minutes	6 minutes
Automatic or manual control / Interval operation		• / ●	● / ●
Automatic after running (extraction/recirculation)		12 / 30 minutes	30 minutes
Dishwasher safe grease filter cassette with spillage collection		Yes - 200ml capacity	Yes - 200ml capacity
Dishwasher safe spillage overflow collector		700ml capacity	700ml capacity
Metal grease filter / Electronic grease filter / cleanAir filter saturation indicators		● / ● / ●	● / ● / ●
PERFORMANCE / TECHNICAL INFORMATION – HOB			
Nominal voltage / Maximum power output	V / W	220-240 / 7,400	220-240 / 7,400
Electrical cable length	cm	110	110
Rear left Induction zone	kW/mm	2.20	2.50
Rear right Induction zone	kW/mm	2.20	2.50
Front left Induction zone	kW/mm	2.20	2.50
Front right Induction zone	kW/mm	2.20	2.50
Flex Induction zone left	kW/mm	3.30	3.60
Flex Induction zone right	kW/mm	3.30	3.60
CombiZone left	kW/mm	•	3.60
CombiZone right	kW/mm	•	3.60
Rear left / right zone – with Power Boost	max. kW	3.70 / 3.70	3.70 / 3.70
Front left / right zone – with Power Boost	max. kW	3.70 / 3.70	3.70 / 3.70
PERFORMANCE / TECHNICAL INFORMATION – EXTRACTOR			
Extractor energy efficiency rating		A B	A B
Extraction Rate in m³/h¹²			
Ducted / Recirculating power level Minimum		154 / 132	154 / 117
Ducted / Recirculating power level Maximum		500 / 499	500 / 487
Ducted / Recirculating power level Intensive		622 / 595	622 / 595
Noise level (sound power) based on dB(A) re 1 pW³			
Ducted / Recirculating power level Minimum		42 / 41	42 / 41
Ducted / Recirculating power level Maximum		69 / 68	69 / 68
Ducted / Recirculating power level Intensive		74 / 72	74 / 72
Motor power		170	170

80CM

70CM

60CM



KEY FEATURES		V58NHQ4L0 N70	V58NBS1L0 N50	V57THQ4L0 N70	V56NBS1L0 N50
NEFF Home Connect		•	•	•	•
Integrated extractor		•	•	•	•
Automatic extraction		Auto-On	Auto-On	Auto-On	Auto-On
Favourite Button		•	•	•	•
Extended Frying Sensor		11 settings	•	11 settings	•
Power Move / Power Boost / Power Transfer		/ ● /	/ ● /	/ ● /	/ ● /
Flex Induction		•	•	•	•
Number of Flex Induction zones		2: Left & Right	1	2: Left & Right	1
Combi Zone Induction		•	•	•	•
HOB FEATURES					
Number of individual zones		4	4	4	4
Power Levels		17	17	17	17
Digital display / Adaptable Volume		● / ●	● / ●	● / ●	● / ●
Count up Timer / Count down timer		/ ●	/ ●	/ ●	/ ●
Main on/off switch / Quick Start / Restart Function / Quick Stop		● / ● / ● /	● / ● / ● /	● / ● / ● /	● / ● / ● /
Energy Consumption Display		•	•	•	•
Pan Recognition / Pan Boost		• /	• /	• /	• /
Demo Mode		•	•	•	•
Dish Categories / Setting Recommendations		Via HC	Via HC	Via HC	Via HC
Keep Warm Function		Via HC / Favourite Button	Via HC / Favourite Button	Via HC / Favourite Button	Via HC / Favourite Button
SAFETY FEATURES					
Residual Heat Indicator / Pause Function		● / ●	● / ●	● / ●	● / ●
Timer with automatic switch off for each zone		•	•	•	•
Control Panel Lock / Safety Time Switch off		● / ●	● / ●	● / ●	● / ●
HOOD FEATURES					
Climate Control sensor		•	•	•	•
Power levels		9 + 2 Intensive	3 + 1 Intensive	9 + 2 Intensive	3 + 1 Intensive
Automatic intensive revert setting		6 minutes	6 minutes	6 minutes	6 minutes
Automatic or manual control / Interval operation		• / ●	• / ●	• / ●	• / ●
Automatic after running (extraction/recirculation)		30 minutes	12 / 30 minutes	30 minutes	12 / 30 minutes
Dishwasher safe grease filter cassette with spillage collection		Yes - 200ml capacity	Yes - 200ml capacity	Yes - 200ml capacity	Yes - 200ml capacity
Dishwasher safe spillage overflow collector		700ml capacity	700ml capacity	700ml capacity	700ml capacity
Metal grease filter / Electronic grease filter / cleanAir filter saturation indicators		● / ● / ●	● / ● / ●	● / ● / ●	● / ● / ●
PERFORMANCE / TECHNICAL INFORMATION – HOB					
Nominal voltage / Maximum power output	V / W	220-240 / 7,400	220-240 / 7,400	220-240 / 7,400	220-240 / 7,400
Electrical cable length	cm	110	110	110	110
Rear left Induction zone	kW/mm	2.50	2.20	2.50	2.20
Rear right Induction zone	kW/mm	190x210	180	190x210	145
Front left Induction zone	kW/mm	2.50	2.20	2.50	2.20
Front right Induction zone	kW/mm	190x210	210	190x210	210
Flex Induction zone left	kW/mm	•	•	•	•
Flex Induction zone right	kW/mm	•	•	•	•
CombiZone left	kW/mm	3.60	3.60	3.60	3.60
CombiZone right	kW/mm	3.60	3.60	3.60	3.60
Rear left / right zone – with Power Boost	max. kW	3.70 / 3.70	3.70 / 3.10	3.70 / 3.70	3.70 / 2.20
Front left / right zone – with Power Boost	max. kW	3.70 / 3.70	3.70 / 3.70	3.70 / 3.70	3.70 / 3.70
PERFORMANCE / TECHNICAL INFORMATION – EXTRACTOR					
Extractor energy efficiency rating		A B	A B	A B	A B
Extraction Rate in m³/h¹²					
Ducted / Recirculating power level Minimum		154 / 117	330 / 252	154 / 117	330 / 252
Ducted / Recirculating power level Maximum		500 / 487	500 / 441	500 / 487	500 / 441
Ducted / Recirculating power level Intensive		622 / 595	622 / 595	622 / 595	622 / 595
Noise level (sound power) based on dB(A) re 1 pW³					
Ducted / Recirculating power level Minimum		42 / 41	61 / 55	42 / 41	61 / 55
Ducted / Recirculating power level Maximum		69 / 68	69 / 66	69 / 68	69 / 66
Ducted / Recirculating power level Intensive		74 / 72	74 / 72	74 / 72	74 / 72
Motor power		170	170	170	170

¹ Air flow and noise declarations made in line with CECEC Code Of Conduct. ² Measured according to EN61591 on largest pipe diameter. ³ Sound power measured according to EN60704-3 on largest pipe diameter.

Wall Mounted Ventilation Solutions

Hoods installed on the wall can be used to create a design feature in themselves, adding a focal point to your kitchen while offering powerful extraction for all types of cooking.

Matt Black with Gloss front panel

NEW Box Chimney *now available*

Elegant and understated design with exceptional performance.

Perfect design – aesthetic design to fit to modern kitchens. Matt Black design accents with gloss control panel, easy to clean.

Automatic Hood Control – Connects to hob using Smart Hood Automatic technology.

Powerful yet quiet high extraction performance with efficient silent drive motor.

Super silent operation – noise 56 dB*

- Classic box design
- Highly Efficient
- Efficient Silent Drive Motor
- Smart Hood Automatic
- Touch Control
- LED Lighting
- Dual-Filter System
- Matt Black chimney & side panels – Front panel gloss

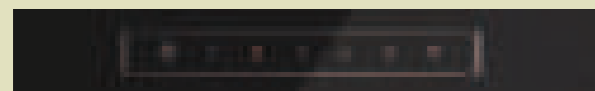

Sleek Touch Control interface



LED low energy lighting



Angled Glass

- Inclined front with dimmable LED mood lighting.
- Fully Automatic Air Sensor.
- Whisper quiet ventilation.
- Chimless or Chimney options.

Pyramid Chimney

- Traditionally styled.
- Broad variety of sizes & specifications.
- Quiet operation.



Wall Installation Hoods

90CM

D98IPT2S0B | N90

- Hob-Hood Control
- ClimateControl Sensor
- Efficient Drive Motor
- NEFF Home Connect
- Adjustable Lighting

SPECIAL FEATURES	
NEFF Home Connect	•
Adjustable LED White Colour Temperature	•
Ambient Light	•
Climate Control Sensor	•
Smart Hood Automatic	•
Hob-hood control	•
Efficient Drive	•
Intensive setting / Automatic intensive revert ¹	•/•
Boost Position (Angled & Flat Hoods)	•
Filter Saturation Indicator	•
FEATURES	
Suitable for ducted operation / recirculating ²	•/•
Electronic power level display	•
Power levels	3 + 2 Intensive
Automatic after running	minutes 10
Lighting	2 x LED lights
Type of control	Touch Control
PERFORMANCE / TECHNICAL INFORMATION	
Energy Rating	A+
Appliance width	mm 890
Extraction Rate in m³/h ^{3,4}	
Power level 3 - ducted / recirculating	441 / 435
Intensive level 1 - ducted / recirculating	753 / 752
Intensive level 2 - ducted / recirculating	1007 / 964
Noise level (sound power) based on dB(A) re 1 pW ^{3,5}	
Power level 3 - ducted / recirculating	51 / 59
Intensive level 1 - ducted / recirculating	65 / 72
Intensive level 2 - ducted / recirculating	70 / 78
Pipe outlet diameter	mm 150
Minimum distance above an electric hob / gas hob ⁶	mm 450 / 650
GB plug	•

80CM		60CM	
D85IFN1S0B N50	D83IDK1S0B N30	D65IFN1S0B N50	D63IDK1S0B N30
<ul style="list-style-type: none"> • Hob-Hood Control • Smart Hood Automatic • Efficient Drive Motor • NEFF Home Connect • Adjustable Lighting <p style="text-align: center;">Discontinuing November 2026</p>	<p style="text-align: center;">Discontinuing December 2026</p>	<ul style="list-style-type: none"> • Hob-Hood Control • Smart Hood Automatic • Efficient Drive Motor • NEFF Home Connect • Adjustable Lighting <p style="text-align: center;">Discontinuing November 2026</p>	<p style="text-align: center;">Discontinuing December 2026</p>
•		•	
•		•	
•		•	
•		•	
•/•	•/•	•/•	•/•
•	•	•	•
via HomeConnect		via HomeConnect	
•/•	•/•	•/•	•/•
•	•	•	•
3 + 1 Intensive	3 + 1 Intensive	3 + 1 Intensive	3 + 1 Intensive
10		10	
2 x LED lights	2 x LED lights	2 x LED lights	2 x LED lights
Touch Control	Touch Control	Touch Control	Touch Control
A+	A	A+	A
790	790	590	590
431 / 429	430 / 445	431 / 429	430 / 445
768 / 724	550 / 550	768 / 724	550 / 550
56 / 62	60 / 69	56 / 62	60 / 69
68 / 74	65 / 72	68 / 74	65 / 72
150	150	150	150
450 / 650	450 / 650	450 / 650	450 / 650
•	•	•	•
D85ICN1S0B / N70 NEW October 2026	D83IDF1S0B / N50 NEW October 2026	D65ICN1S0B / N70 NEW October 2026	D63IDF1S0B / N50 NEW October 2026

THE NEFF OVEN COLLECTIONS

HOBS

VENTILATION

REFRIGERATION

DISHWASHING

LAUNDRY

¹Power automatically reverts back to normal setting after intensive. ²A type of recirculating kit is required if recirculating. ³Air Flow and noise declarations made in line with CECEC Code of Conduct. ⁴Measured according to EN61591 on largest pipe diameter. ⁵Sound power measured according to EN60704-3 on largest pipe diameter. ⁶From top of pan supports. Depending on the model, a 'Recirculating odour filter kit' will consist of the following items: Charcoal filter, flexible hose, air duct, fixing components, installation instructions.

Box Chimney Hoods

	90CM	60CM	60CM
	D97BDN2S0B N70	D95BCC2S0B N50	D67BDN2S0B N70
	<ul style="list-style-type: none"> Efficient Silent Drive Motor Smart Hood Automatic Touch Control LED Lighting Dual-Filter System 	<ul style="list-style-type: none"> Energy-efficient Capacitor Motor Push Button Control LED Lighting Dual-Filter System 	<ul style="list-style-type: none"> Efficient Silent Drive Motor Smart Hood Automatic Touch Control LED Lighting Dual-Filter System
			
SPECIAL FEATURES			
NEFF Home Connect	•		•
Adjustable Colour Temperature / Brightness LED	•		•
Smart Hood Automatic	•		•
Hob-hood control	•		•
Efficient Drive	•		•
Intensive setting / Automatic intensive revert ¹	• / •		• / •
Filter saturation indicator			
FEATURES			
Suitable for ducted operation/recirculating ²	• / •	• / •	• / •
Electronic power level display	•		•
Power levels	3 + 1 Intensive	3	3 + 1 Intensive
Automatic after running minutes	10		10
Lighting	2 x LED lights	2 x LED lights	2 x LED lights
Type of control	Touch Control	Push Button Control	Touch Control
PERFORMANCE / TECHNICAL INFORMATION			
Energy Rating	A++	B	A++
Appliance width mm	898	898	598
Extraction Rate in m³/h^{3,4}			
Power level 3 ducted / recirculating	399 / 410	594 / 569	399 / 410
Intensive level 1 ducted / recirculating	699 / 677		699 / 677
Intensive level 2 ducted / recirculating			-
Noise level (sound power) based on dB(A) re 1 pW^{3,5}			
Power level 3 ducted / recirculating	56 / 64	67 / 71	56 / 64
Intensive level 1 ducted / recirculating	68 / 73		68 / 73
Intensive level 2 ducted / recirculating			-
Pipe outlet diameter mm	150 / 120	150 / 120	150 / 120
Minimum distance above an electric hob / gas hob ⁶ mm	550 / 650	550 / 650	550 / 650
GB plug	•	•	•

	60CM
	D65BCC2S0B N50
	<ul style="list-style-type: none"> Energy-efficient Capacitor Motor Push Button Control LED Lighting Dual-Filter System
	
FEATURES	
Suitable for ducted operation/recirculating ²	• / •
Electronic power level display	•
Power levels	3
Automatic after running minutes	10
Lighting	2 x LED lights
Type of control	Push Button Control
PERFORMANCE / TECHNICAL INFORMATION	
Energy Rating	B
Appliance width mm	598
Extraction Rate in m³/h^{3,4}	
Power level 3 ducted / recirculating	594 / 569
Intensive level 1 ducted / recirculating	-
Intensive level 2 ducted / recirculating	-
Noise level (sound power) based on dB(A) re 1 pW^{3,5}	
Power level 3 ducted / recirculating	67 / 71
Intensive level 1 ducted / recirculating	-
Intensive level 2 ducted / recirculating	-
Pipe outlet diameter mm	150 / 120
Minimum distance above an electric hob / gas hob ⁶ mm	550 / 650
GB plug	•

Pyramid Chimney Hoods

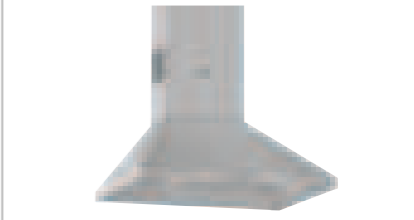
	60CM
	D62PBC0N0B N30
	
FEATURES	
Suitable for ducted operation/recirculating	• / •
Electronic power level display	
Power levels	3
NEFF Fresh Air (Interval operation)	
Automatic after running minutes	
Lighting	2 x LED lights
Softlight with dimmer function	
Number of metal grease filter cassettes	2
Type of control	Push Buttons
PERFORMANCE / TECHNICAL INFORMATION	
Energy Rating	D
Appliance width mm	600
Extraction Rate in m³/h^{3,4}	
Power level 1 ducted / recirculating	198 / 127
Power level 2 ducted / recirculating	263 / 171
Power level 3 ducted / recirculating	365 / 211
Noise level (sound power) based on dB(A) re 1 pW^{3,5}	
Power level 1 ducted / recirculating	50 / 55
Power level 2 ducted / recirculating	58 / 62
Power level 3 ducted / recirculating	66 / 67
Pipe outlet diameter mm	150 / 120
Minimum distance above an electric hob / gas hob ⁶ mm	550 / 650
GB plug	•

Integrated Furniture Ventilation Solutions

A great fit

Offering improved performance, reduced noise and a fresh, modern look the NEFF range of Integrated Design Hoods is the new standard for wall-cabinet extractors. Understated or bold, these space-saving hoods blend seamlessly with any kitchen while delivering a quiet, powerful fan to keep air fresh and steam-free.

Available in Telescopic, Canopy and Integrated styles.

Integrated Design Hood

The Integrated Design Hood sits flush with your kitchen units and stays virtually invisible until use, when only a hinged glass panel appears.

Maximum storage – Its smart layout offers personalisable upper-cabinet storage, holding up to 20kg of storage.

Seamlessly integrated – in operation the matt black panel folds out and a special coating hides fingerprints for easier cleaning.

Automatic Hood Control – NEFF's 1st connected hood with automatic hob-hood control – Smart Automatic Air sensor & smart hood automatic.

Powerful efficient silent drive motor is effective and quiet – 57dB* – so won't interrupt conversation.

The Integrated Design Hood can be installed by a single person – thanks to the well thought out design, construction and installation guide. Perfect replacement for telescopic or canopy hoods.

*(exhaust mode, highest normal level)



Wonderfully practical when open while being beautiful and seamless when closed

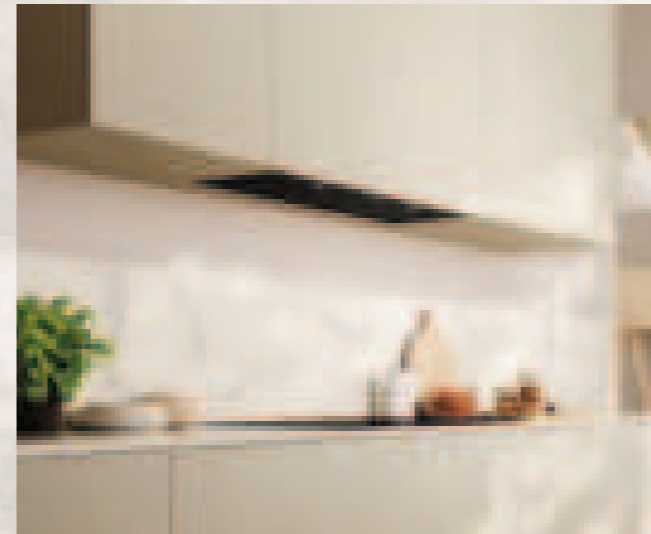
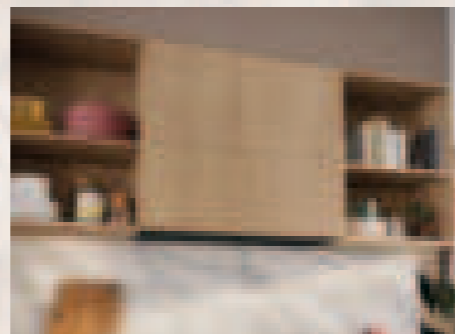
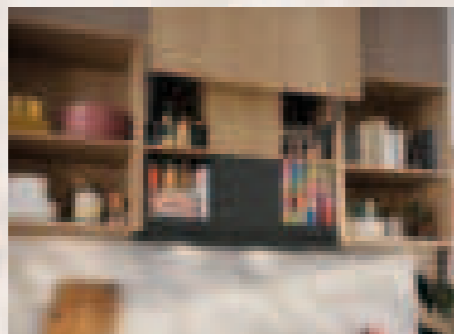

Canopy Hoods

Thanks to the Hidden Design feature your integrated Canopy Hood is practically invisible, disappearing in your kitchen cabinets. The flush-fitted design of your hood keeps your kitchen sleek and clutter-free.

Our hoods combine high-extraction motors that remove steam and odours at the source, whisper quiet operation, and bright LED lighting for a cleaner, calmer, and better-lit cooking experience.



Telescopic Hood

- For a smaller kitchen where space is at a premium, these clever hoods pull out from underneath a cabinet when required.

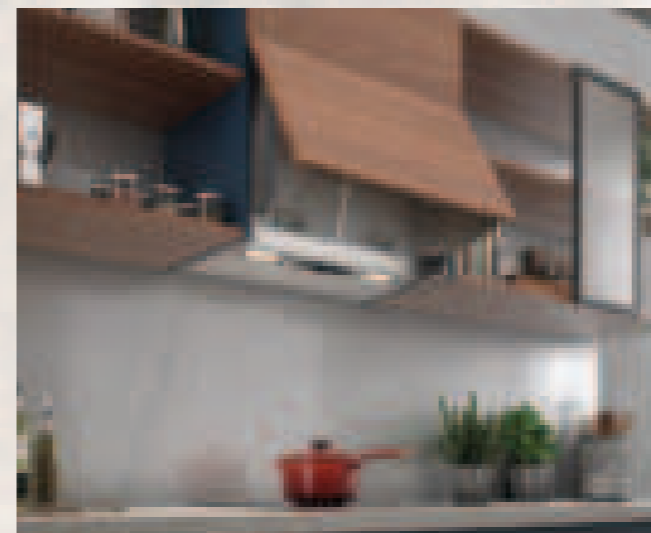

Integrated Hood



- These hoods look like they're part of the furniture.
- Hidden behind a unit door, they simply pull out when needed.

Integrated Design Hoods

90CM

D98XET2S0B N90	D95XCC2S0B N50
<ul style="list-style-type: none"> • 10kg Storage Each Side • Efficient Silent Drive Motor • Smart Automatic Air Sensor • Glass Panel with Touch Control • LED Lighting • Dual-Filter System • Matt Black with Gloss front panel 	<ul style="list-style-type: none"> • 10kg Storage Each Side • Energy-efficient Capacitor Motor • Push Button Control • LED Lighting • Dual-Filter System • Matt Black with Gloss front panel 

80CM 60CM

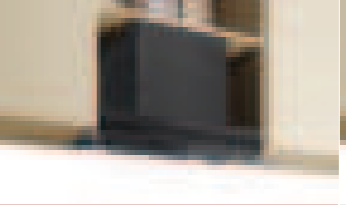
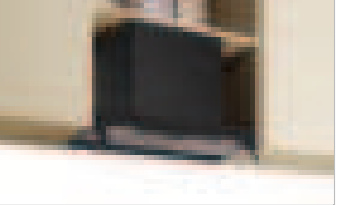
D88XET2S0B N90	D85XCC2S0B N50	D68XET2S0B N90	D65XCC2S0B N50
<ul style="list-style-type: none"> • 10kg Storage Each Side • Efficient Silent Drive Motor • Smart Automatic Air Sensor • Glass Panel with Touch Control • LED Lighting • Dual-Filter System • Matt Black with Gloss front panel 	<ul style="list-style-type: none"> • 10kg Storage Each Side • Energy-efficient Capacitor Motor • Push Button Control • LED Lighting • Dual-Filter System • Matt Black with Gloss front panel 	<ul style="list-style-type: none"> • 10kg Storage Each Side • Efficient Silent Drive Motor • Smart Automatic Air Sensor • Glass Panel with Touch Control • LED Lighting • Dual-Filter System • Matt Black with Gloss front panel 	<ul style="list-style-type: none"> • 10kg Storage Each Side • Energy-efficient Capacitor Motor • Push Button Control • LED Lighting • Dual-Filter System 

FEATURES		
Storage Space	10kg each side	10kg each side
NEFF Home Connect	•	
Adjustable Colour Temperature/Brightness LED	•	
Smart Automatic Air Sensor	•	
Smart Hood Automatic		
Hob-hood control	•	
Favourite Button	•	
EcoSilence Drive Motor	•	
Intensive setting / Automatic intensive revert 1	• / •	
Filter Saturation Indicator	•	
FEATURES		
Suitable for ducted operation / recirculating 2	• / •	• / •
Power levels	3 + 2 Intensive	3
Automatic after running min	10	
Lighting	2 x LED lights	2 x LED lights
Type of Control	Glass Panel with Touch Control	Push Button Control
PERFORMANCE / TECHNICAL INFORMATION		
Energy	A+	B
Appliance width mm	898	898
Extraction Rate in m³/h^{3,4}		
Ducted power level 1 / recirculating power level 1	427 / 414	583 / 521
Ducted power level 2 / recirculating power level 2	693 / 584	
Ducted power level 3 / recirculating power level 3	851 / 656	
Noise level (sound power) based on dB(A) re 1 pW^{3,5}		
Ducted power level 1 / recirculating power level 1	57 / 66	65 / 72
Ducted power level 2 / recirculating power level 2	69 / 73	
Ducted power level 3 / recirculating power level 3	73 / 76	
Pipe outlet diameter mm	150 / 120	150 / 120
Minimum distance above an electric hob / gas hob ⁶ mm	430 / 650	430 / 650
GB plug	•	•

Storage Space	10kg each side	10kg each side	10kg each side	10kg each side
NEFF Home Connect	•		•	
Adjustable Colour Temperature/Brightness LED	•		•	
Smart Automatic Air Sensor	•		•	
Smart Hood Automatic				
Hob-hood control	•		•	
Favourite Button	•		•	
EcoSilence Drive Motor	•		•	
Intensive setting / Automatic intensive revert 1	• / •		• / •	
Filter Saturation Indicator	•		•	
FEATURES				
Suitable for ducted operation / recirculating 2	• / •	• / •	• / •	• / •
Power levels	3 + 2 Intensive	3	3 + 2 Intensive	3
Automatic after running min	10		10	
Lighting	2 x LED lights	2 x LED lights	2 x LED lights	2 x LED lights
Type of Control	Glass Panel with Touch Control	Push Button Control	Glass Panel with Touch Control	Push Button Control
PERFORMANCE / TECHNICAL INFORMATION				
Energy	A+	B	A+	B
Appliance width mm	798	798	598	598
Extraction Rate in m³/h^{3,4}				
Ducted power level 1 / recirculating power level 1	427 / 414	583 / 521	427 / 414	583 / 521
Ducted power level 2 / recirculating power level 2	693 / 584		693 / 584	
Ducted power level 3 / recirculating power level 3	851 / 656		851 / 656	
Noise level (sound power) based on dB(A) re 1 pW^{3,5}				
Ducted power level 1 / recirculating power level 1	57 / 66	65 / 72	57 / 66	65 / 72
Ducted power level 2 / recirculating power level 2	69 / 73		69 / 73	
Ducted power level 3 / recirculating power level 3	73 / 76		73 / 76	
Pipe outlet diameter mm	150 / 120	150 / 120	150 / 120	150 / 120
Minimum distance above an electric hob / gas hob ⁶ mm	430 / 650	430 / 650	430 / 650	430 / 650
GB plug	•	•	•	•

¹Power automatically reverts back to normal setting after intensive. ²A type of recirculating kit is required if recirculating. ³Air Flow and noise declarations made in line with CECEC Code of Conduct. ⁴Measured according to EN61591 on largest pipe diameter. ⁵Sound power measured according to EN60704-3 on largest pipe diameter. ⁶From top of pan supports. Depending on the model, a 'Recirculating odour filter kit' will consist of the following items: Charcoal filter, flexible hose, air duct, fixing components, installation instructions.

Canopy Hoods

	86CM	73CM	70CM
	D86NAC1S0B N70	D5855X2GB N30	D75NAC1S0B N70
SPECIAL FEATURES			
Intensive setting / Automatic intensive revert ¹	● / ●		● / ●
Filter saturation indicator			
FEATURES			
Suitable for ducted operation / recirculating ²	● / ●	● / ●	● / ●
Automatic after running minutes			
Lighting	2 x LED lights	2 x LED lights	2 x LED lights
Controls	Push Button	Slider switch	Push Button
Power levels	3 + 1 Intensive	3 + 1 Intensive	3 + 1 Intensive
PERFORMANCE / TECHNICAL INFORMATION			
Energy	B	D	B
Appliance width mm	860	730	700
Extraction Rate in m³/h ^{3,4}			
Ducted power level 3 / recirculating power level 3	595 / 580	468 / 281	595 / 580
Ducted intensive / recirculating intensive	730 / 705	614 / 324	730 / 705
Noise level (sound power) based on dB(A) re 1 pW ^{3,5}			
Ducted power level 3 / recirculating power level 3	63 / 77	63 / 70	63 / 77
Ducted intensive / recirculating intensive	68 / 73	68 / 73	68 / 73
Pipe outlet diameter mm	150 / 120	150	150 / 120
Minimum distance above an electric hob / gas hob ⁶ mm	500 / 650	650 / 650	500 / 650
GB plug	●	●	●

	53CM	52CM	
	D5655X2GB N30	D51NAA1C0B N30	D54NAC1S0B N70
SPECIAL FEATURES			
Intensive setting / Automatic intensive revert ¹	● /		● / ●
Filter saturation indicator			
FEATURES			
Suitable for ducted operation / recirculating ²	● / ●	● / ●	● / ●
Automatic after running minutes			
Lighting	2 x LED lights	2 x LED lights	2 x LED lights
Controls	Slider switch	Slider switch	Push Button
Power levels	3 + 1 Intensive	3	3 + 1 Intensive
PERFORMANCE / TECHNICAL INFORMATION			
Energy	C	D	B
Appliance width mm	530	530	520
Extraction Rate in m³/h ^{3,4}			
Ducted power level 3 / recirculating power level 3	362 / 268	302 / 300	570 / 560
Ducted intensive / recirculating intensive	618 / 395		645 / 628
Noise level (sound power) based on dB(A) re 1 pW ^{3,5}			
Ducted power level 3 / recirculating power level 3	56 / 64	62 / 65	66 / 69
Ducted intensive / recirculating intensive	68 / 72		68 / 72
Pipe outlet diameter mm	150 / 120	120	150 / 120
Minimum distance above an electric hob / gas hob ⁶ mm	550 / 650	550 / 650	500 / 650
GB plug	●	●	●

Telescopic Hoods

	90CM	60CM
	D49ED22N1B N50	D46ED22N1B N50
<ul style="list-style-type: none"> Efficient Drive Motor Automatic After Run 		
SPECIAL FEATURES		
Intensive setting / Automatic intensive revert ¹	● / ●	● / ●
Efficient Drive	●	●
FEATURES		
Suitable for ducted operation / recirculating ²	● / ●	● / ●
Furniture door required	●	●
Automatic after running minutes	10	10
Lighting	3 x LED lights	2 x LED lights
Controls	Soft touch	Soft touch
Power levels	3 + 1 Intensive	3 + 1 Intensive
PERFORMANCE / TECHNICAL INFORMATION		
Energy	A	A
Appliance width mm	898	598
Extraction Rate in m³/h ^{3,4}		
Ducted power level 3 / recirculating power level 3	266 / 166	271 / 174
Intensive level 1 - ducted / recirculating	412 / 178	405 / 189
Noise level (sound power) based on dB(A) re 1 pW ^{3,5}		
Ducted power level 3 / recirculating power level 3	63 / 70	62 / 70
Intensive level 1 - ducted / recirculating	70 / 71	69 / 72
Pipe outlet diameter mm	150 / 120	150 / 120
Minimum distance above an electric hob / gas hob ⁶ mm	430 / 650	430 / 650
GB plug	●	●

Integrated Hoods

	90CM
	D64MAC1X0B N30
FEATURES	
Suitable for ducted operation / recirculating ²	● / ●
Furniture door required	●
Lighting	2 x LED lights
Controls	Push buttons
Power levels	3
Number of metal grease filter cassettes	2
PERFORMANCE / TECHNICAL INFORMATION	
Energy	B
Appliance width mm	599
Extraction Rate in m³/h ^{3,4}	
Ducted power level 1 / recirculating power level 1	256 / 208
Ducted power level 2 / recirculating power level 2	352 / 320
Ducted power level 3 / recirculating power level 3	625 / 416
Noise level (sound power) based on dB(A) re 1 pW ^{3,5}	
Ducted power level 1 / recirculating power level 1	49 / 57
Ducted power level 2 / recirculating power level 2	56 / 68
Ducted power level 3 / recirculating power level 3	70 / 75
Pipe outlet diameter mm	150 / 120
Minimum distance above an electric hob / gas hob ⁶ mm	500 / 650
GB plug	●

¹Power automatically reverts back to normal setting after intensive. ²A type of recirculating kit is required if recirculating. ³Air Flow and noise declarations made in line with CECEC Code of Conduct. ⁴Measured according to EN61591 on largest pipe diameter. ⁵Sound power measured according to EN60704-3 on largest pipe diameter. ⁶From top of pan supports. Depending on the model, a 'Recirculating odour filter kit' will consist of the following items: Charcoal filter, flexible hose, air duct, fixing components, installation instructions.

Flex Design Hood Ranges

Hood Width Size	Collection	Flex Design Glass Draft Hood	Colour	NEFF Home Connect	Model Code
90cm	N 90	Guided Air technology, Ambient Light, Touch control	Clear Glass	Yes	I98WMM1Y7B
80cm	N 90	Guided Air technology, Ambient Light, Touch control	Clear Glass	Yes	I88WMM1Y7B
Hood Width Size	Collection	Angled Hood	Colour	NEFF Home Connect	Model Code
90cm	N 90	Automatic air sensor, cooktop-based Hood Control	Black Glass	Yes	D98IPT2Y5

Island Hood Ranges

CEILING HOODS						
Width	Series	Description	Hob Hood Control /Remote Control	NEFF Home Connect	Colour	Model Number
90cm	N50	90 x 50cm, LED lights.	● / ●	✓	Stainless steel	I95CAQ6N0B
WORKTOP INSTALLATION						
90cm	N90	New Guided Air, Climate Control Sensor, touch control, remote mountable motor up to 3m, with Ambient Light.	● /	✓	Black with clear glass	I98WMM1S7B
80cm	N90	New Guided Air, Climate Control Sensor, touch control, remote mountable motor up to 3m, with Ambient Light.	● /	✓	Black with clear glass	I88WMM1S7B
90cm	N90	New Guided Air, Climate Control Sensor, touch control, remote mountable motor up to 3m, with Ambient Light.	● /	✓	Black with clear glass	I98WMM1Y7B
80cm	N90	New Guided Air, Climate Control Sensor, touch control, remote mountable motor up to 3m, with Ambient Light.	● /	✓	Black with clear glass	I88WMM1Y7B

Wall Mounted Hood Ranges

ANGLED GLASS CHIMNEY HOODS						
Width	Series	Description	Hob Hood Control /Remote Control	NEFF Home Connect	Colour	Model Number
90cm	N90	Flex Design Touch Control with illuminated sensors, Ambient light, Climate Control Sensor, LED Lights.	● /	✓	Black Glass & Stainless steel chimney	D98IPT2Y5
90cm	N90	Touch Control with illuminated sensors, Ambient light, Climate Control Sensor, LED Lights.	● /	✓	Black Glass & Stainless steel chimney	D98IPT2S0B
80cm	N50	Single Pane Angled Glass Chimney Hood, SoftTouch Control, LED Lights.	● /	✓	Black Glass & Stainless steel control	D85IFN1S0B
80cm	N30	Angled Chimney Hood, Touch Control, LED Lights.		✓	Black Glass & Stainless steel control	D83IDK1S0B
60cm	N50	Touch Control, LED Lights.	● /	✓	Black Glass & Black Chimney	D65IFN1S0B
60cm	N30	60cm, Angled Chimney Hood, Touch Control, LED Lights.		✓	Black Glass & Stainless steel control	D63IDK1S0B
BOX CHIMNEY HOODS						
90cm	N70	Automatic After Run, Touch Control, EfficientDrive Motor, Smart Hood Automatic, Intensive Setting	● /	✓	Matt Black with Gloss front panel	D97BDN2S0B
90cm	N50	Push Button Control			Matt Black with Gloss front panel	D95BCC2S0B
60cm	N70	Automatic After Run, Touch Control, EfficientDrive Motor, Smart Hood Automatic, Intensive Setting	● /	✓	Matt Black with Gloss front panel	D67BDN2S0B
60cm	N50	Push Button Control			Matt Black with Gloss front panel	D65BCC2S0B
PYRAMID CHIMNEY HOODS						
60cm	N30	3 speed, LED lights.			Stainless steel	D62PBC0N0B

Integrated Hood Ranges

INTEGRATED DESIGN HOODS						
Width	Series	Description	Hob Hood Control /Remote Control	NEFF Home Connect	Colour	Model Number
90cm	N90	10kg each side, Automatic After Run, Touch Control, EfficientDrive Motor, Intensive Setting	● /	✓	Matt Black with Gloss front panel	D98XET2S0B
90cm	N50	10kg each side			Matt Black with Gloss front panel	D95XCC2S0B
80cm	N90	10kg each side, Automatic After Run, Touch Control, EfficientDrive Motor, Intensive Setting	● /	✓	Matt Black with Gloss front panel	D88XET2S0B
80cm	N50	10kg each side			Matt Black with Gloss front panel	D85XCC2S0B
60cm	N90	10kg each side, Automatic After Run, Touch Control, EfficientDrive Motor, Intensive Setting	● /	✓	Matt Black with Gloss front panel	D68XET2S0B
60cm	N50	10kg each side			Matt Black with Gloss front panel	D65XCC2S0B
CANOPY HOODS						
86cm	N70	3 speed + intensive, 2 x LED lights, Push Button			Black	D86NAC1S0B
73cm	N30	3 speed + intensive, 2 x LED lights, Push Button			Metallic silver	D5855X2GB
70cm	N70	Rim Ventilation Design, 3 speed + intensive, electronic, LED lights.			Stainless steel	D75NAC1S0B
53cm	N30	3 speed + intensive, 2 x LED lights, Push Button			Metallic silver	D5655X2GB
53cm	N30	3 speed, LED lights, Quick fix system, Slider switch.			Metallic silver	D51NAA1C0B
52cm	N70	Rim Ventilation Design, 3 speed + intensive, electronic, LED lights.			Stainless steel	D54NAC1S0B
TELESCOPIC HOODS						
90cm	N50	3 speed + 1 Intensive, Easy Electronic Controls, LED lights.			Stainless Steel	D49ED22N1B
60cm	N50	3 speed + 1 Intensive, Easy Electronic Controls, LED lights.			Stainless Steel	D46ED22N1B
INTEGRATED HOODS						
60cm	N30	3 speed, push buttons, LED lights, high extraction rate.			Metallic silver	D64MAC1X0B

Colour Coordinated Flex Design Side Trims

FLEX DESIGN TRIMS - HOODS				
Pack Contents	Anthracite Grey	Brushed Bronze	Deep Black	Metallic Silver
2 x Glass Draft Side Trims	Z5802GLAY0	Z5802GLBY0	Z5802GLDY0	Z5802GLMY0
Optional colour coordinated Flex Design Trims for Seamless Installation linking Flex Design Hobs to Flex Design GlassDraft Extractor	Z9302GLAY0	Z9302GLBY0	Z9302GLDY0	Z9302GLMY0
2 x Angled Hood Side Trims	Z91BIE9AY0	Z91BIE9BY0	Z91BIE9DY0	Z91BIE9MY0

Flex Design Worktop Installation Hoods

90CM
I98WMM1Y7B

Technical drawings for the 90cm hood I98WMM1Y7B. The top row shows an exploded view of the hood and its components, followed by a side view and a front view with dimensions. The middle row shows a perspective view of the hood and a list of dimensions. The bottom row shows two side views of the hood and a perspective view of the hood with dimensions.

80CM
I88WMM1Y7B

Technical drawings for the 80cm hood I88WMM1Y7B. The top row shows an exploded view of the hood and its components, followed by a side view and a front view with dimensions. The middle row shows a perspective view of the hood and a list of dimensions. The bottom row shows two side views of the hood and a perspective view of the hood with dimensions.

Worktop Installation Hoods

90CM
I98WMM1S7B

Technical drawings for the 90cm hood I98WMM1S7B. The top row shows an exploded view of the hood and its components, followed by a side view and a front view with dimensions. The middle row shows a perspective view of the hood and a list of dimensions. The bottom row shows two side views of the hood and a perspective view of the hood with dimensions.

80CM
I88WMM1S7B

Technical drawings for the 80cm hood I88WMM1S7B. The top row shows an exploded view of the hood and its components, followed by a side view and a front view with dimensions. The middle row shows a perspective view of the hood and a list of dimensions. The bottom row shows two side views of the hood and a perspective view of the hood with dimensions.

Measurements in mm. The line drawings featured in this brochure are provided as a guide to general dimensions only and are subject to amendment without prior notice. For full dimensional and installation details please refer to the documentation supplied with the appliance.

Ceiling Installation Hood

90CM
I95CAQ6N0B

The fan outlet can be turned in all four directions

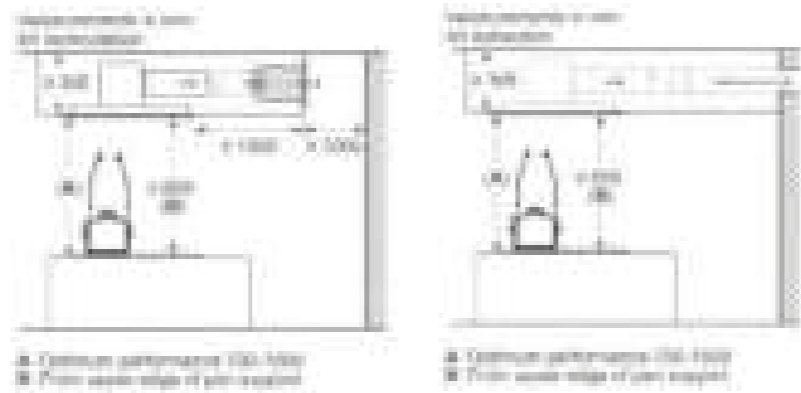
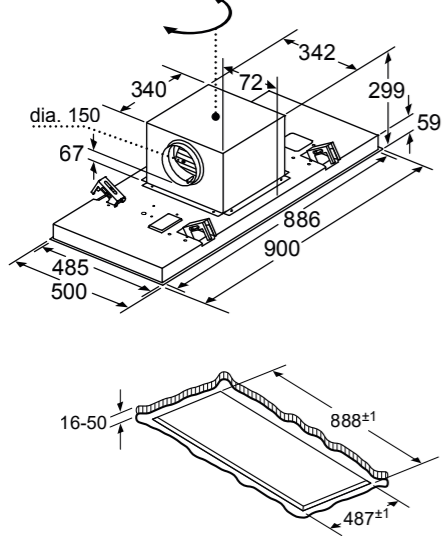

Never fit directly onto plasterboard or similar lightweight construction materials of the suspended ceiling. A suitable substructure is required that is securely fixed to the concrete ceiling.

Wall Installation Hoods

90CM
D98IPT2S0B



Flex Design Wall Installation Hoods

90CM
D98IPT2Y5

Measurements in mm
Measurements in millimetres

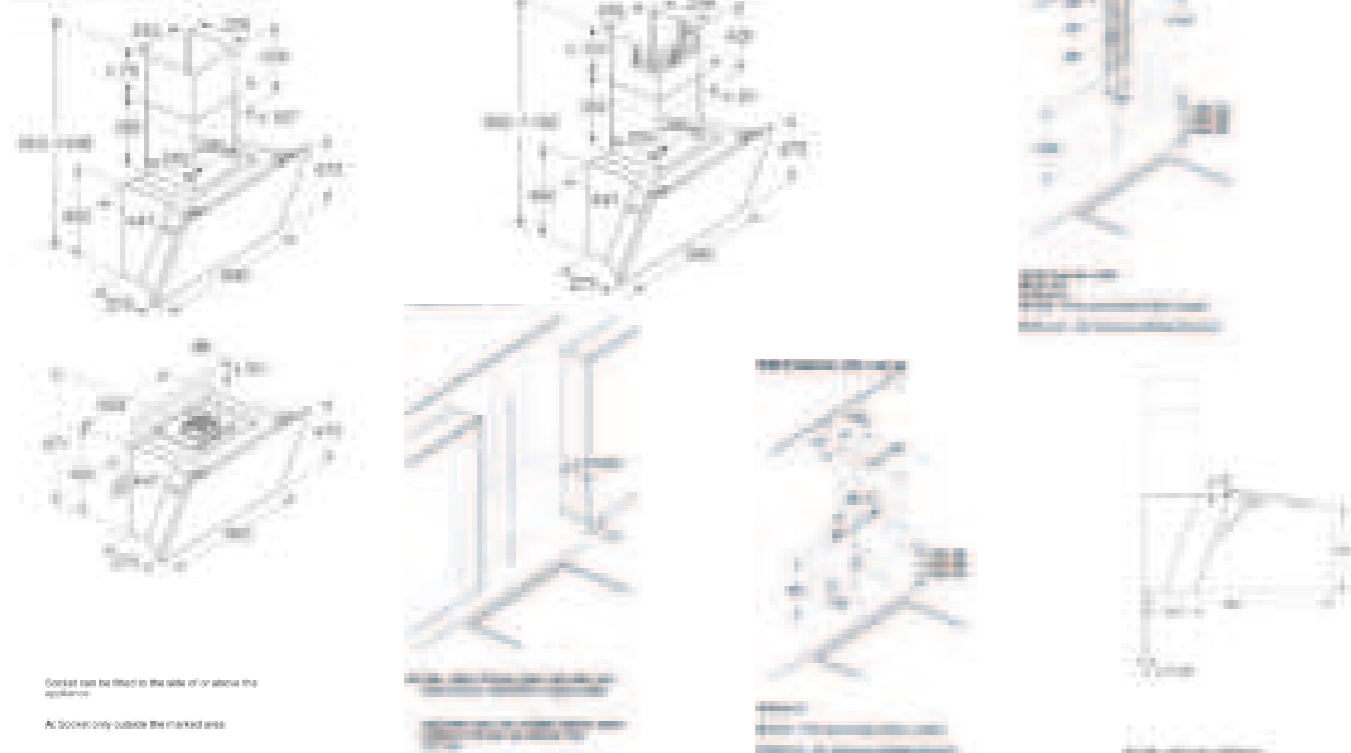

Can be fitted to the side of or above the appliance.
As shown only outside the marked area.

80CM
D85IFN1S0B

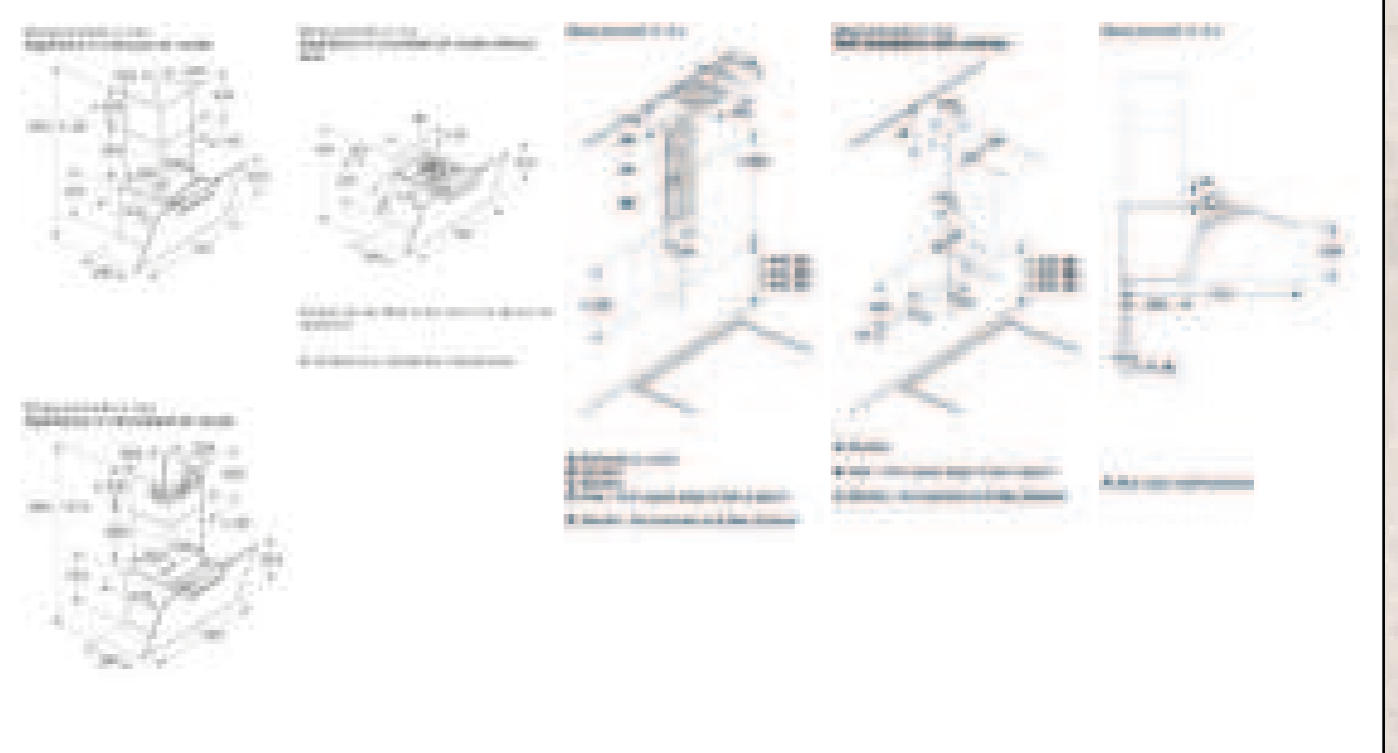

Measurements in mm. The line drawings featured in this brochure are provided as a guide to general dimensions only and are subject to amendment without prior notice. For full dimensional and installation details please refer to the documentation supplied with the appliance.

Wall Installation Hoods

80CM
D83IDK1S0B

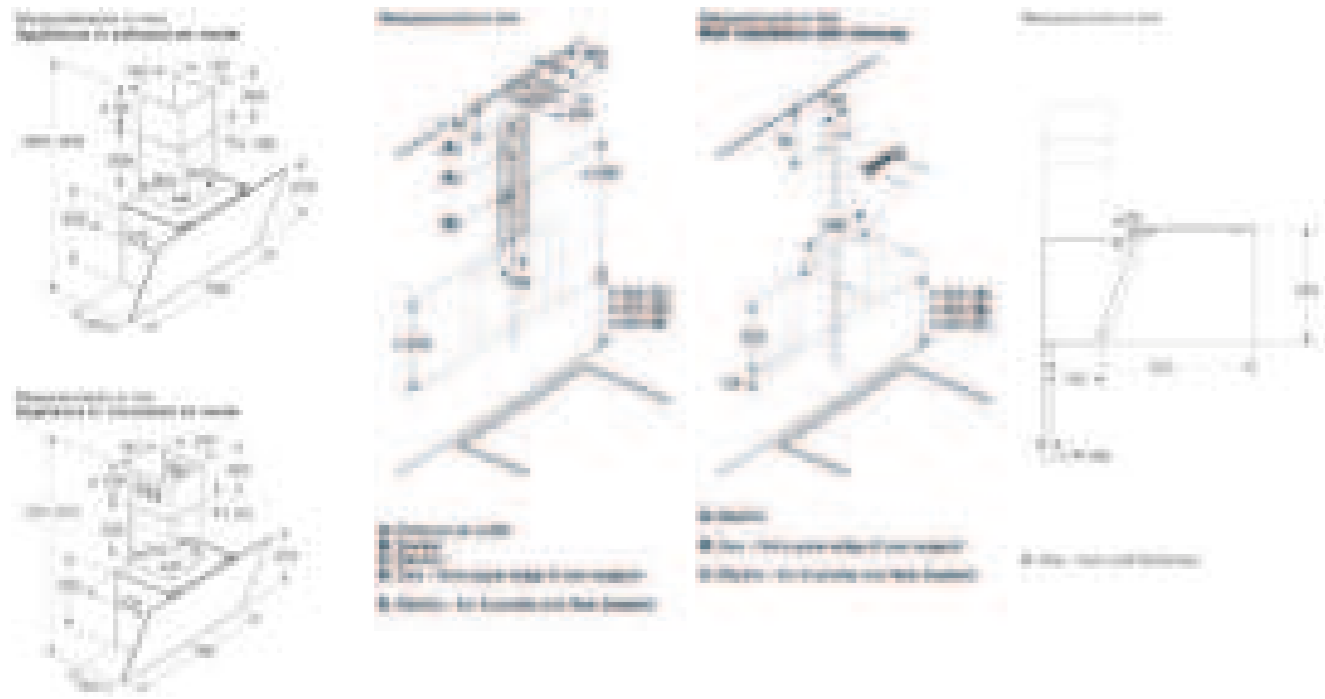

60CM
D63IDK1S0B

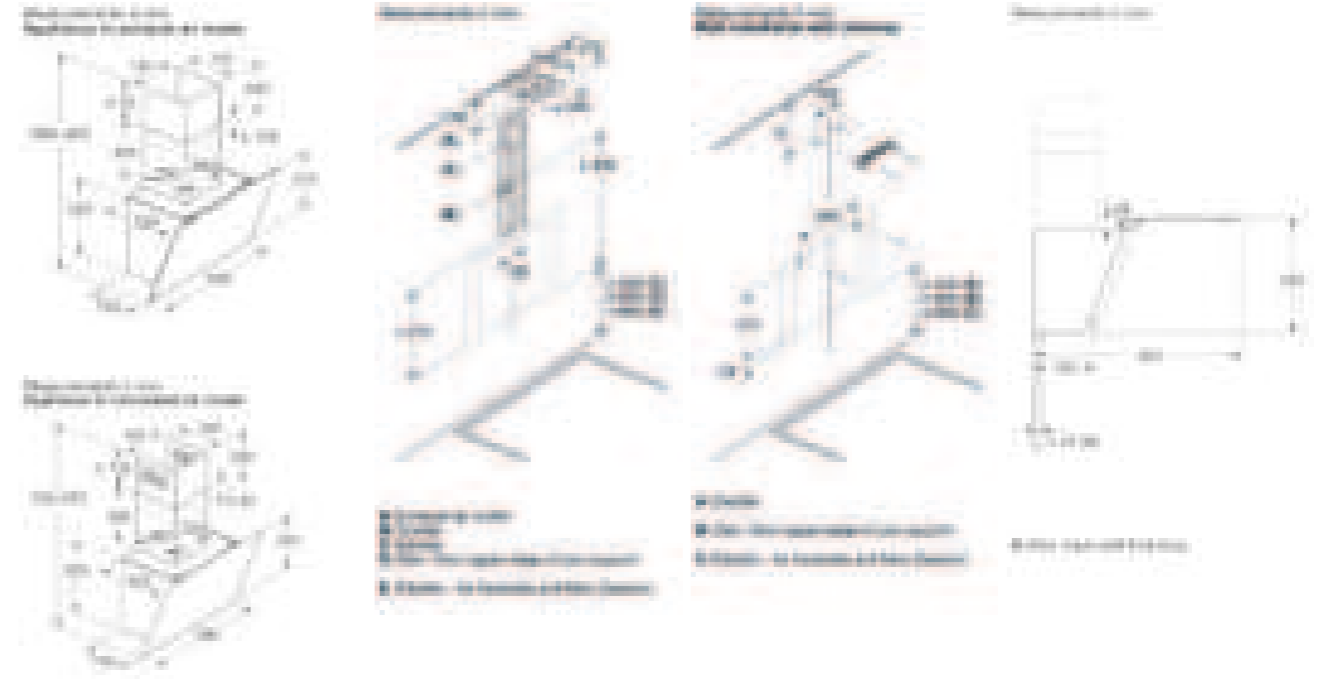

60CM
D65IFN1S0B

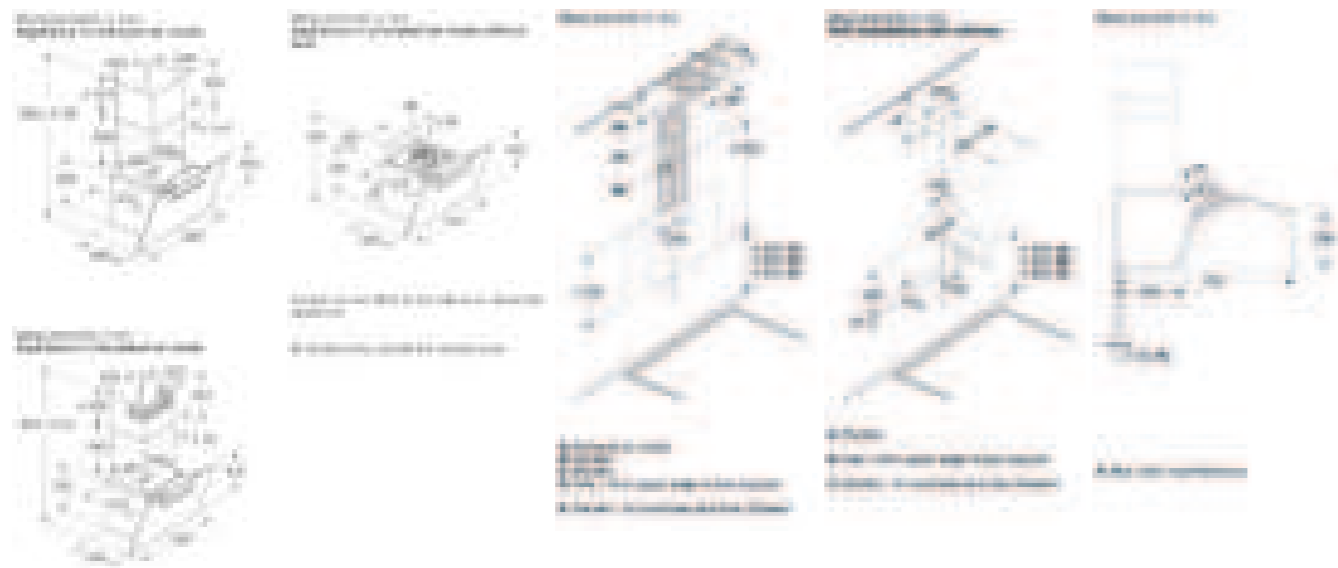

Box Chimney Hoods

90CM
D97BDN2S0B

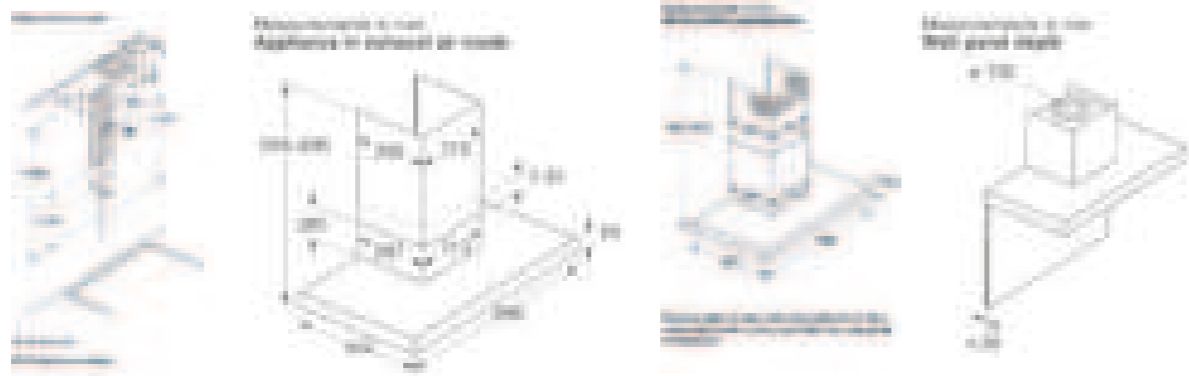

90CM
D95BCC2S0B

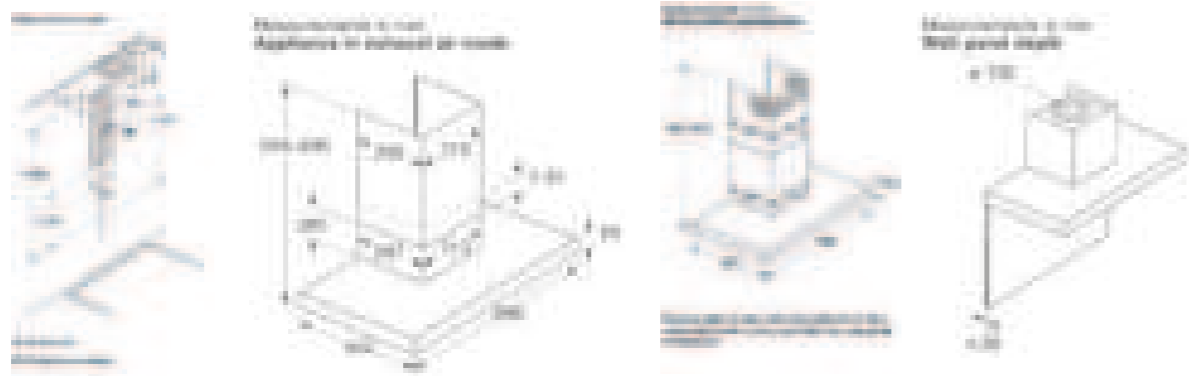

60CM
D67BDN2S0B

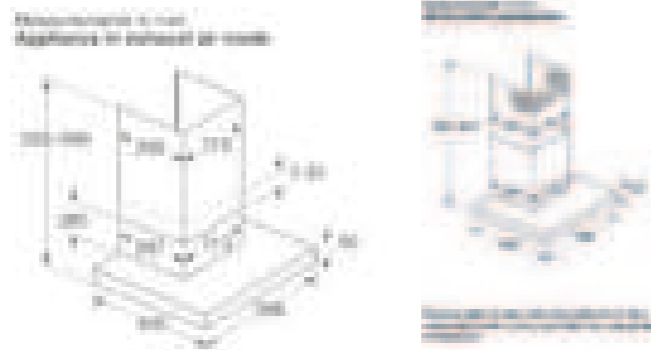

60CM
D65BCC2S0B

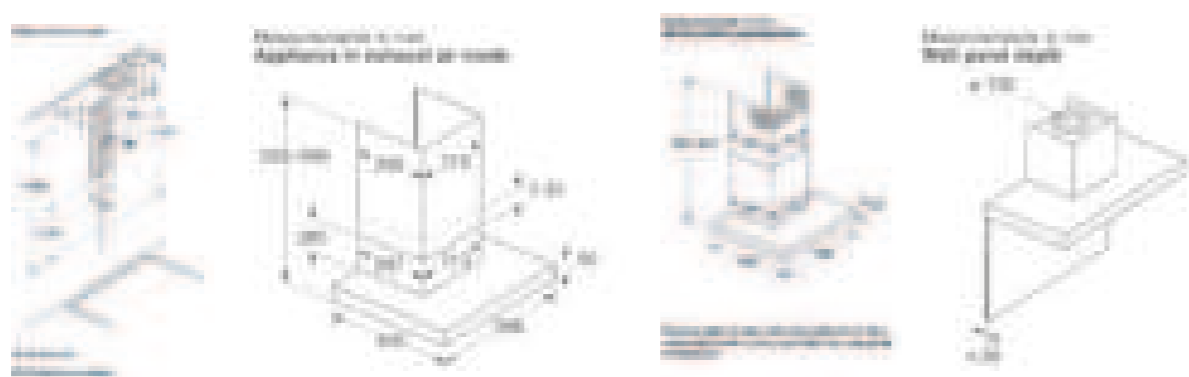

Pyramid Chimney Hoods

60CM
D62PBC0N0B

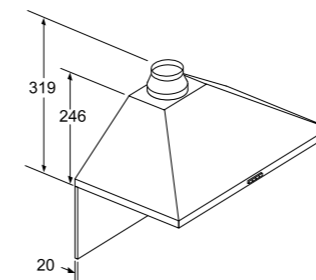

If a back panel is used, the design of the appliance must be considered.

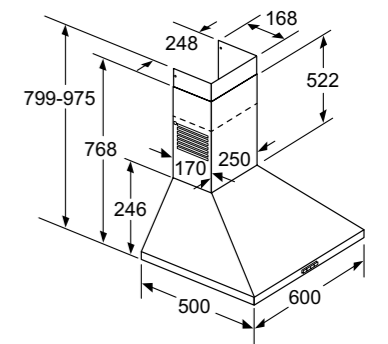

Telescopic Hoods

90CM
D49ED22N1B

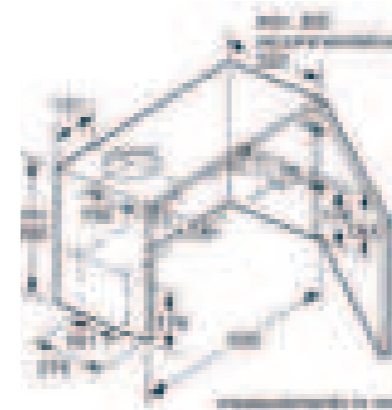

60CM
D46ED22N1B

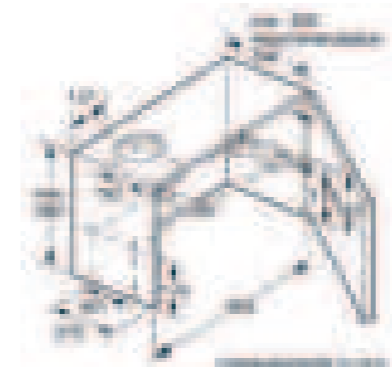

Canopy Hoods

86CM
D86NAC1S0B

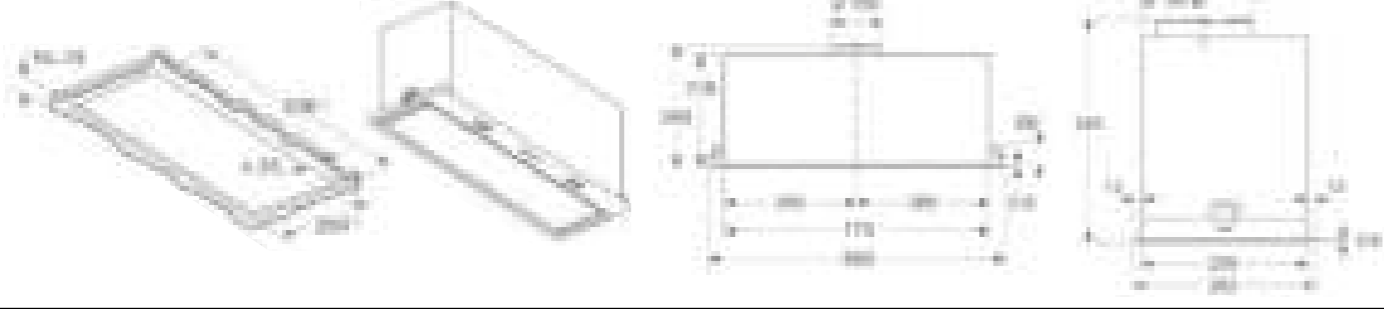

73CM
D5855X2GB

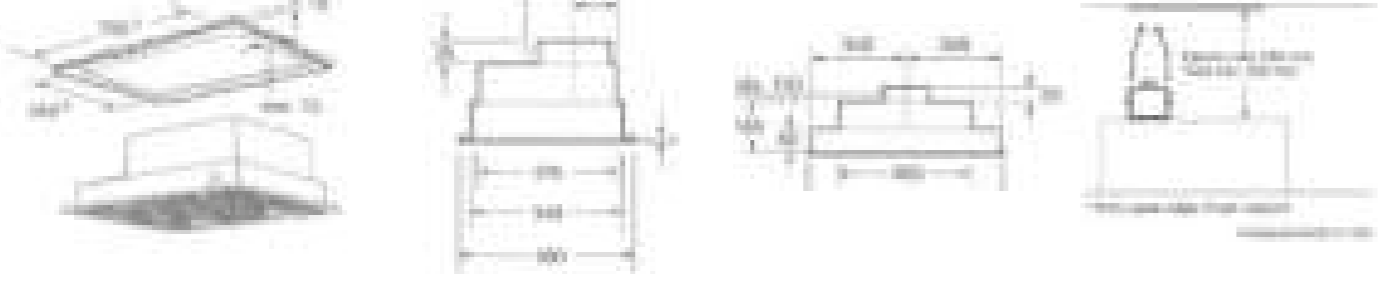

70CM
D75NAC1S0B

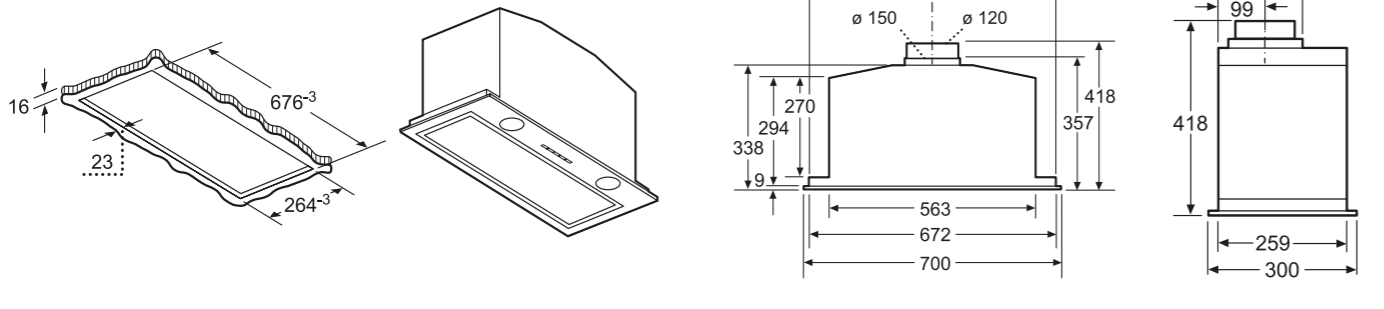

53CM
D5655X2GB

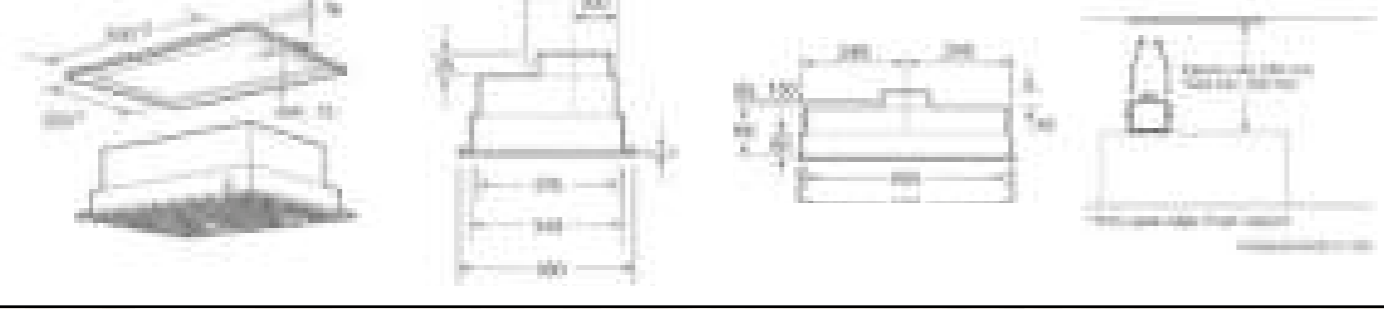

53CM
D51NAA1C0B

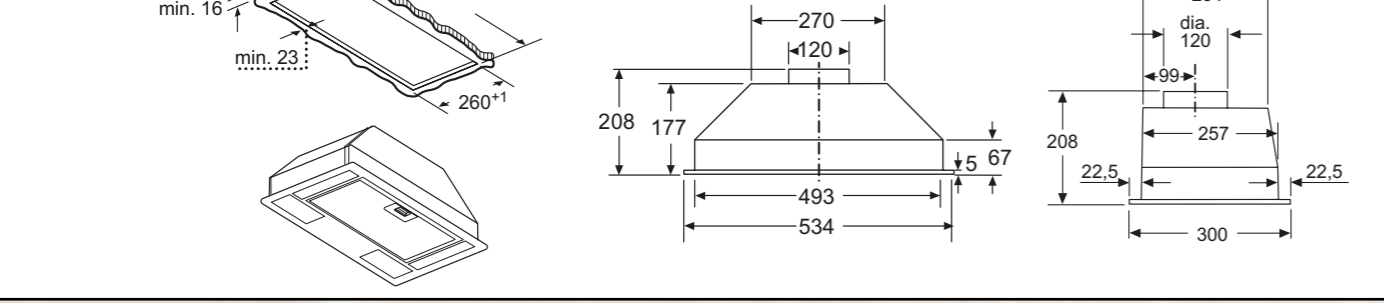

52CM
D54NAC1S0B

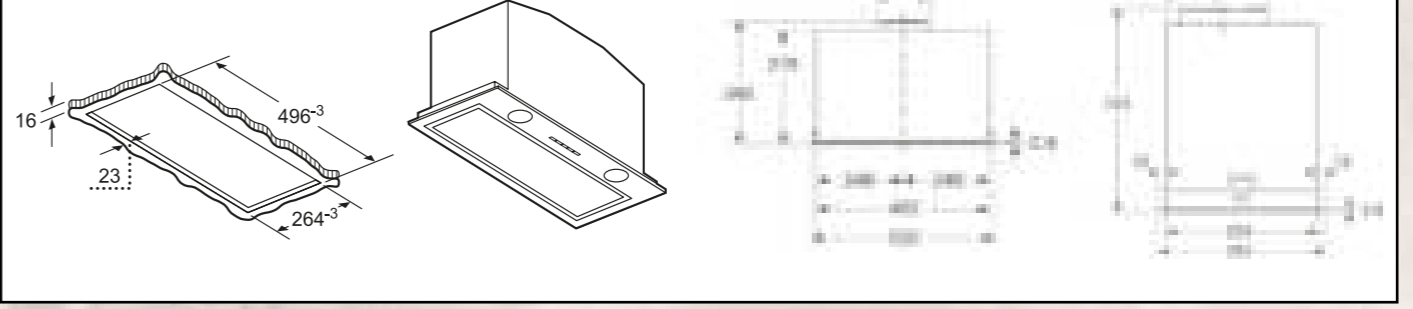

Integrated Hoods

60CM
D64MAC1X0B

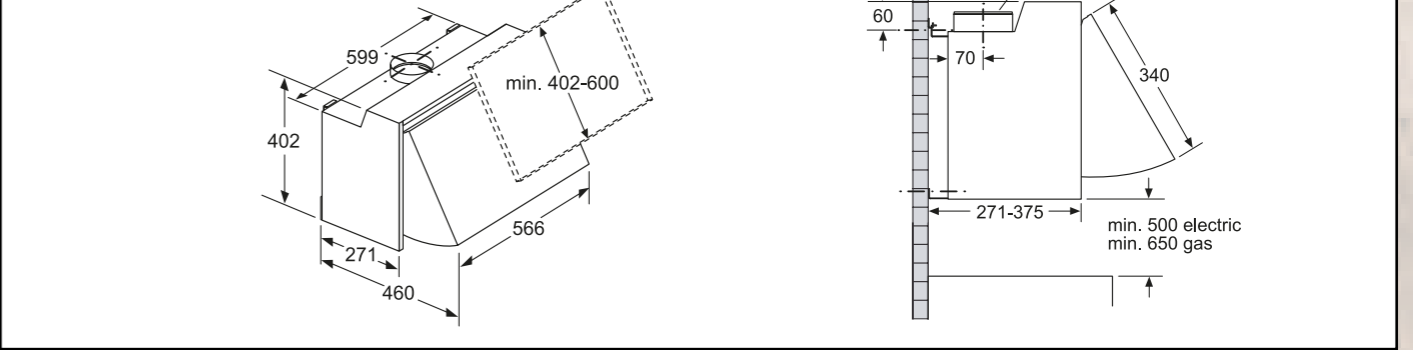

Integrated Design Hoods

90CM
D98XET2S0B

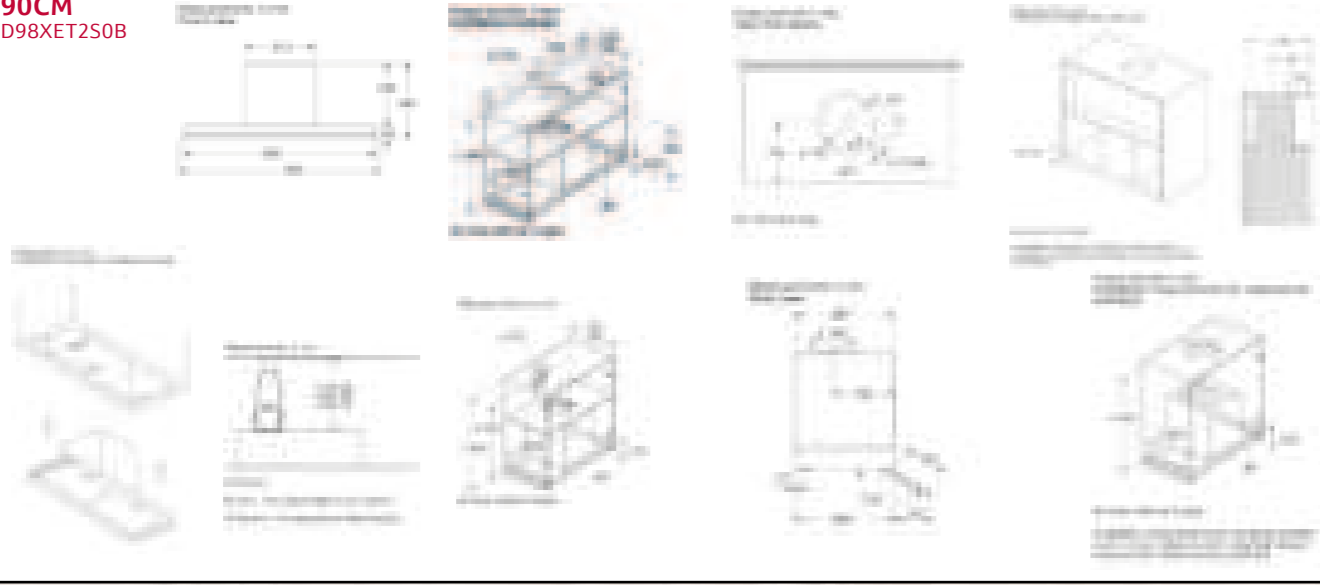

80CM
D85XCC2S0B

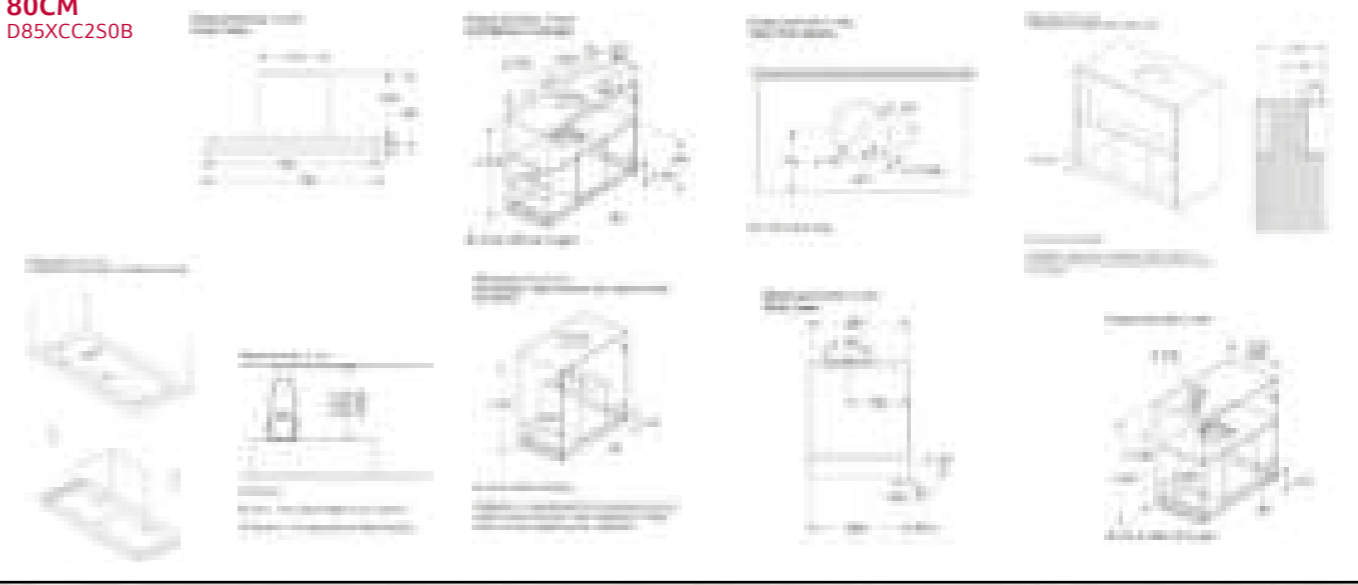

90CM
D95XCC2S0B

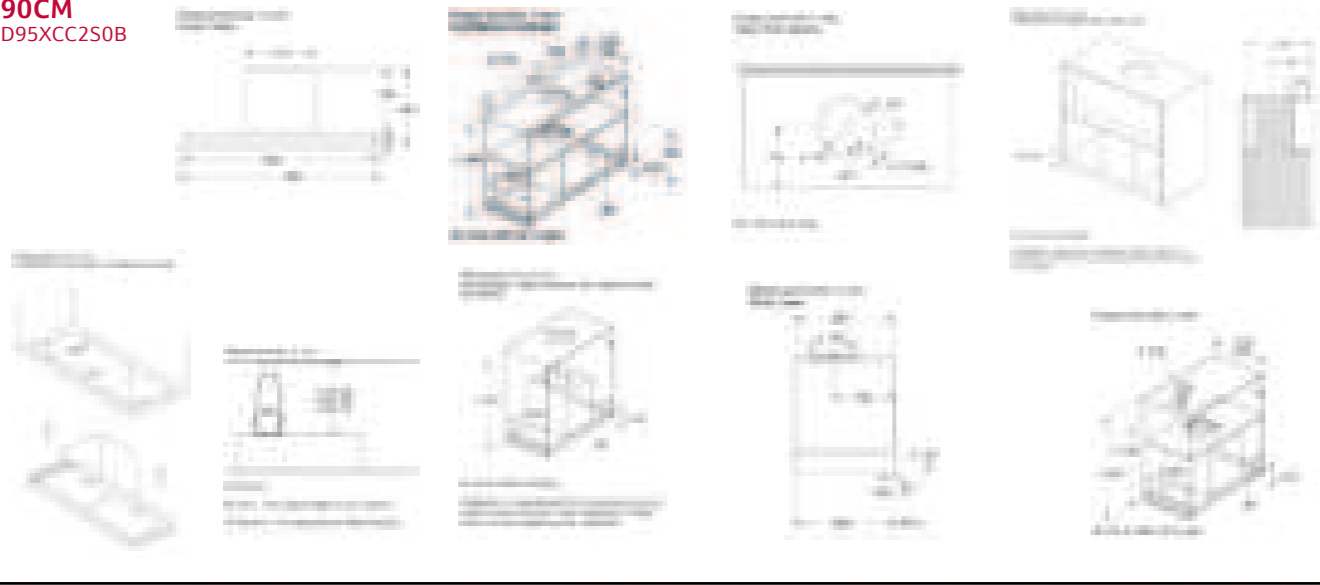

60CM
D68XET2S0B

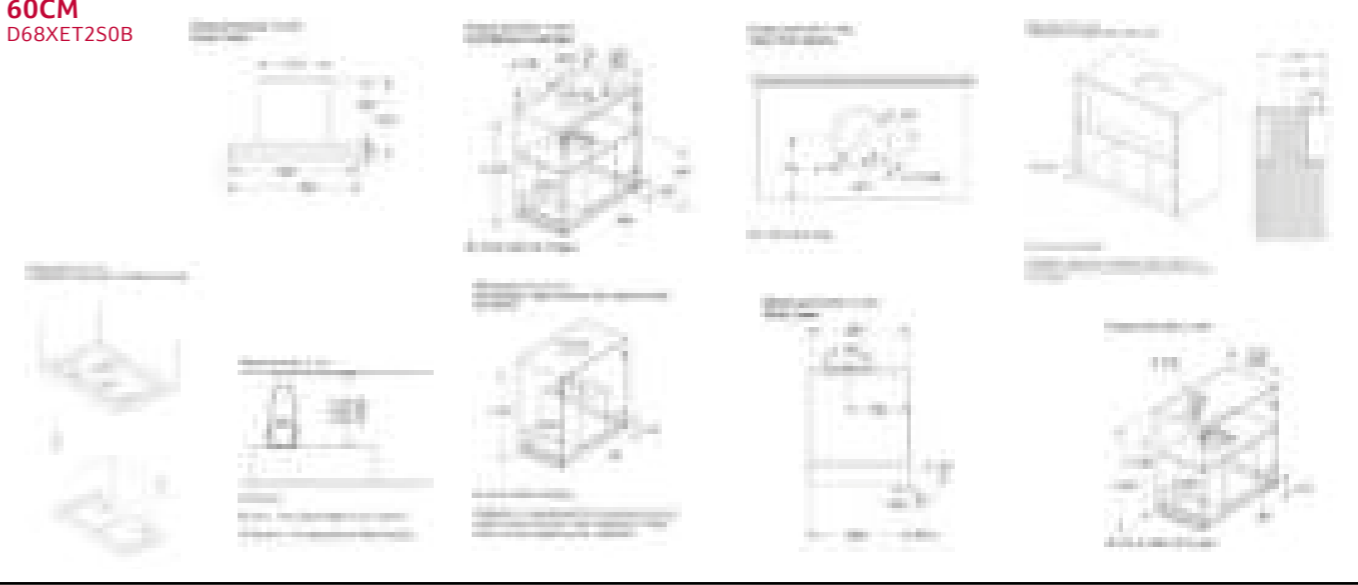

80CM
D88XET2S0B

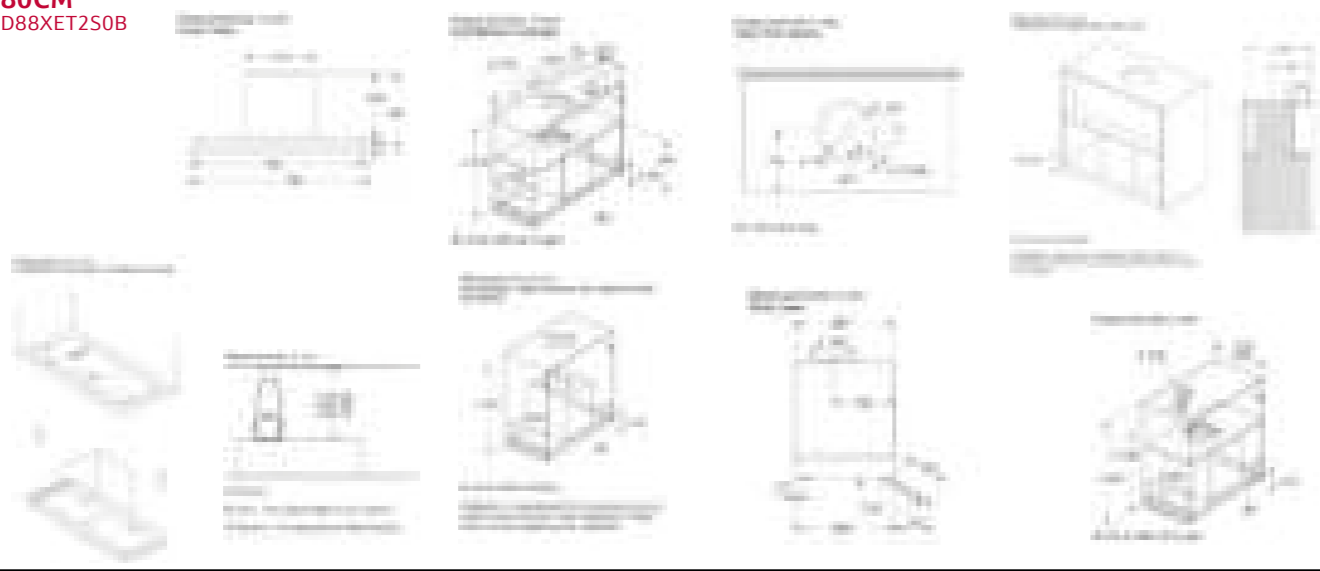

60CM
D65XCC2S0B

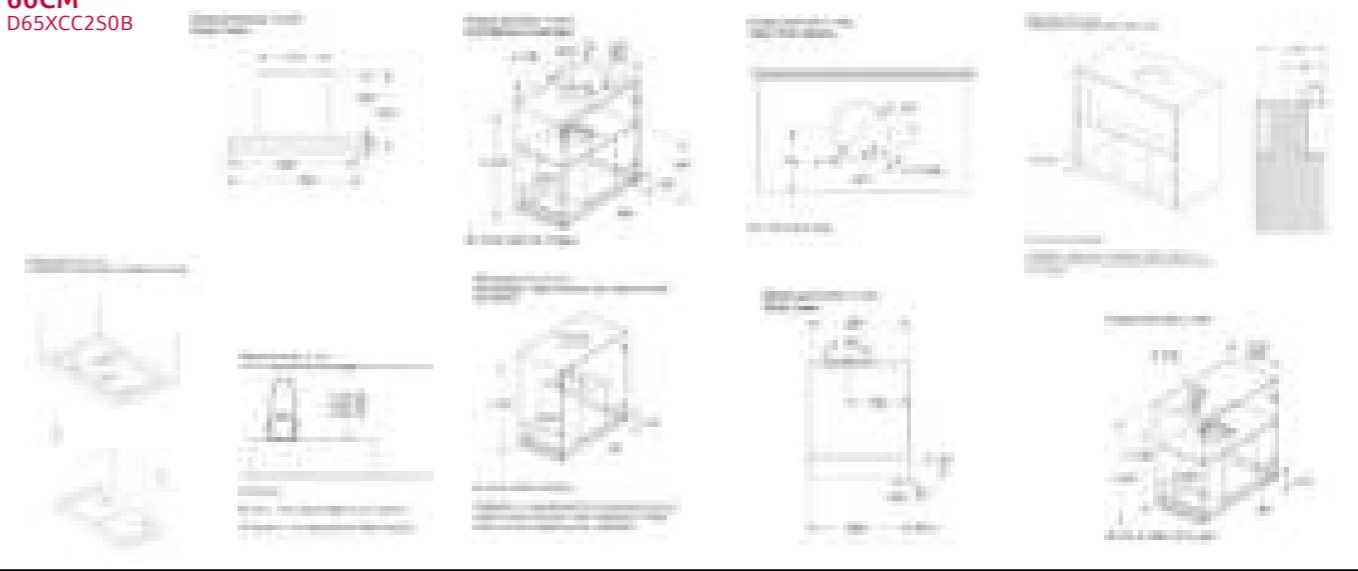

THE NEFF OVEN COLLECTIONS

HOBS

VENTILATION

REFRIGERATION

DISHWASHING

LAUNDRY

NEFF COOLING *Range*



Let's keep it fresh

Fridges and freezers for food lovers.

- Fridges and Freezers are essential for any home chef and finding the perfect solution is easy with the NEFF Cooling Range.
- The range is comprehensive in both the features and the installation.
- NEFF's range of cooling appliances focuses on Built In integrated models with a range of Fridges/Freezers in a variety of sizes and splits, and a range of single door Fridges and Freezers. This means that a customer can choose just how much fridge and freezer space they need, whilst the range of hinges allows scope to include in a variety of kitchen designs – neatly integrated as part of the overall kitchen.
- The NEFF range is packed with features to really care for ingredients. With many key cooling features, customers have the flexibility to build exactly what they want in their kitchen.
- The range is clearly laid out in height order leading with Fridge Freezers followed by the single appliance range.
- For those who want extra capacity, the XL & XXL are the newest additions designed to cope with the largest demands.
- Many of NEFF's cooling range are covered by our **5 year warranty** – clearly marked in the matrix tables. Further warranty information can be found on NEFF Customer Service pages 262-263.

Built-In Fridge Freezer Guide

Fridge Freezers

Comprehensive range of models to suit customer needs.

- Available in two heights
 - Standard 177cm in various “splits” 70/30, 60/40, 50/50 of Fridge to Freezer.
 - The New 193.5cm tall XL & XXL range – available in a 60/40 split of Fridge to Freezer.
- Available in fixed & sliding hinge to accommodate design and kitchen furniture.
- All Fridge Freezers have a 4-star rating.



Hinge Types

Hinges to suit all kitchen designs

Our doors can be right-hinged or left-hinged in order to suit your kitchen design.

Fixed Hinge & Soft Close Hinge

The benefit of this type of hinge is that it carries more weight – ideal for kitchen cabinetry made from heavier hard wood. This hinge also allows the door to open at a wider angle, making the fridge cavity easily accessible. All NEFF doors close automatically when at an angle of approximately 15-20° and selected models have the benefit of Soft Close.

Sliding Hinge

Our sliding hinge feature sits between the appliance and the furniture door and is secured by a series of brackets. As you open the furniture door, the appliance door is also opened via the sliding bracket design.

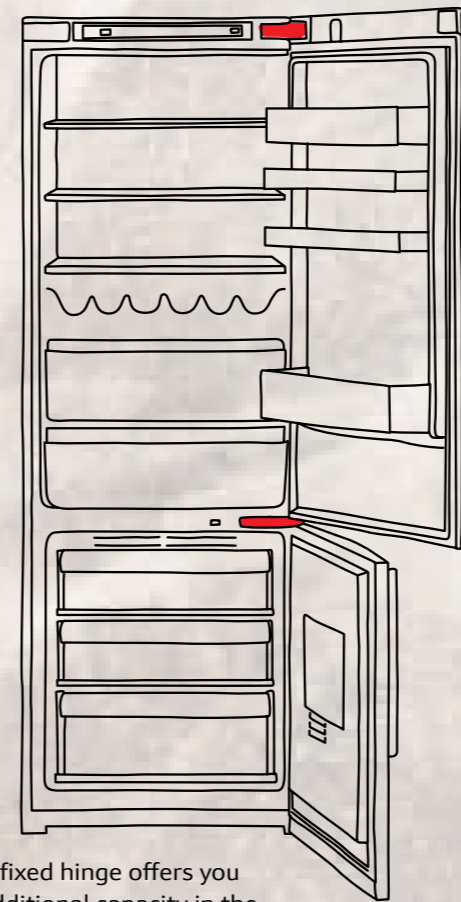

A fixed hinge offers you additional capacity in the refrigerator, leaving you more room for your food.

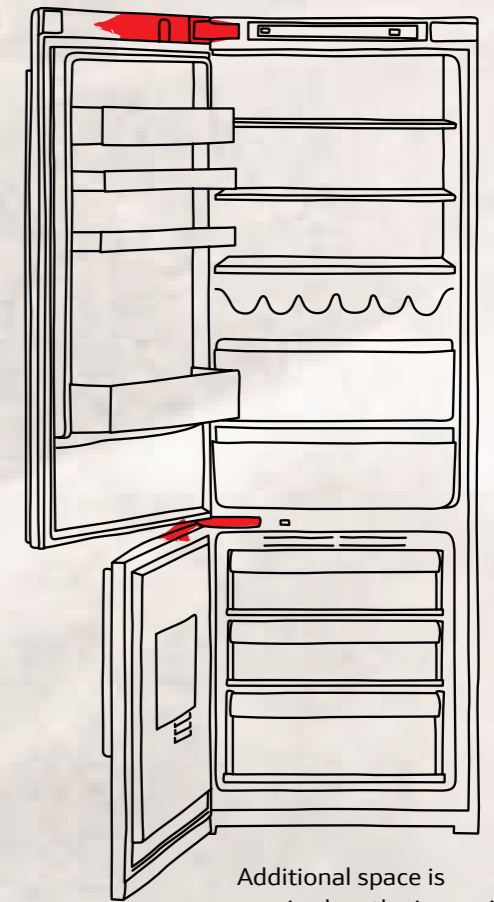

Additional space is required on the inner side of the cabinet to make way for the door hinge.

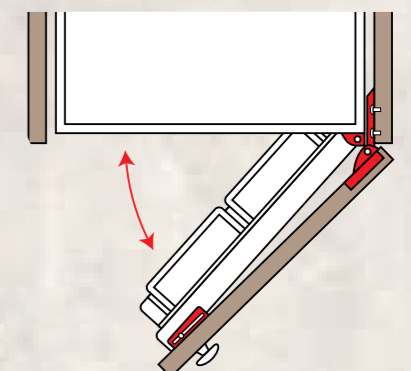
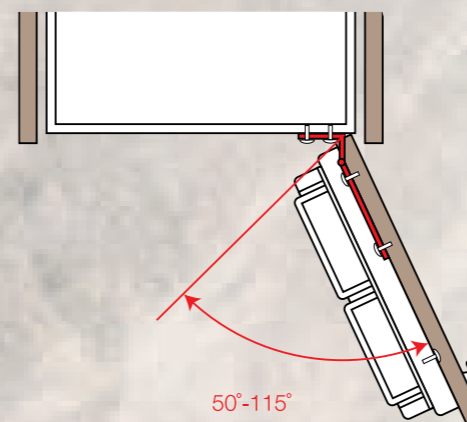

Built-In Single Fridge & Freezer Guide

Single Fridges & Single Freezers

For customers looking to install a single fridge and freezer this range will suit their needs.

- Available in several heights to create a bespoke cooling solution.
- Extensive installation combinations – Side by Side, Over & Under & Built Under options available.
- All appliances have a 4-star rating.



Size Guide & Installation Options

Combination and layout solutions for installing cooling appliances

With so many kitchen styles to choose from, at NEFF we've catered for all spaces and lifestyles. With the option to build a cooling solution shaped to specific requirements, our installation options are designed to offer the ultimate flexibility. From side-by-side fridge and freezer installations to over-under stacked installations, it's easy to incorporate NEFF appliances into the overall kitchen design.

Installation Solutions

- The range can be installed Over/Under to create a bespoke solution.
- Depending on the fridge and freezer capacity required, the range can be installed to create the ideal solution.
- The range can be installed Side by Side and the Tall Fridge & Freezer create equal fridge and freezer capacity.

Over/Under installation options

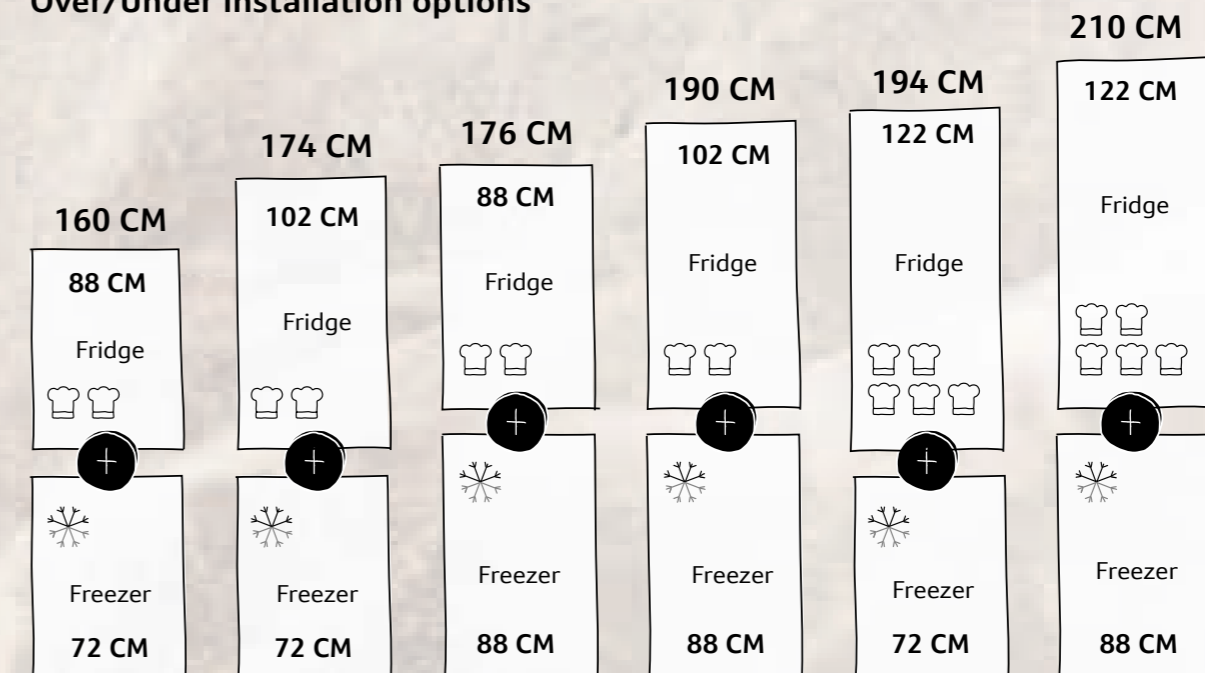

Side by Side installation options

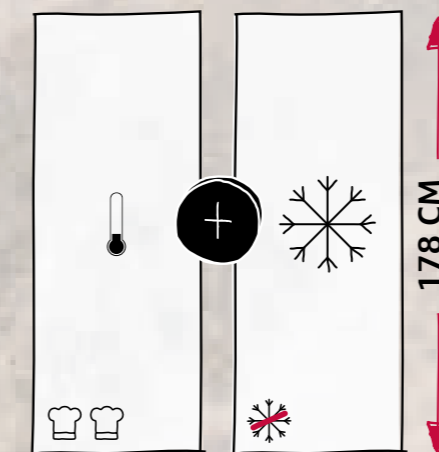

Other Styles



Freestanding Fridge Freezers

NEFF now offers a choice of configuration – Side by Side or the NEW multi-door format.

- With the new multi-door format the top fridge compartment with the double door opening features full width shelves - perfect for a big shop or prepared meals.
- For a built in appearance, it's possible to install the freestanding fridge within a cabinet run and add a decorative surround – the appliance is not fully integrated into cabinetwork, so ensure adequate airflow.

Both appliances feature:

- Flexible shelving throughout for adaptable storage.
- NoFrost technology in both fridge and freezer – no manual defrosting.
- Ice & water dispenser – In party mode the ice maker can make 5kg of ice in 24 hours – perfect when hosting.

Built Under Solutions



Wine Cabinets

- Available in two widths; 30cm – 21 bottle capacity /60cm – 44 bottle capacity
- 2 in 1 Temperature Zone (5°C-20°C)
- Individual temperature zones to store white and red wine.
- Interior light



Built Under Fridges & Freezers

- 82cm high to install under a worktop
- Super Cool with NEFF Home Connect app
- Some models with 4 star freezer section
- LED lighting

Your guide to Cooling

SERIES FUNCTIONS				
Product Function	N 90	N 70	N 50	N 30
NEFF Home Connect	•	-	•	•
Fresh Safe	Fresh Safe 3	Fresh Safe 2	Fresh Safe	Fresh Safe
No Frost/Low Frost	•/-	•/•	•/•	•/•
Vario Shelf	•	•	-	-
Wire Flex Shelf	•	-	-	-
Easy Access Shelf	•	•	-	-
Easy Lift Shelf	•	-	-	-
Flexi Rail Drawers	•	-	-	-
LED Display	•	•	•	-
Electronic Control	-	-	•	-
Energy Rating	E or F	E or F	E or F	F
Super Cool	•	•	•	-
Fresh Sense	•	•	-	-
Soft Close/Fixed/Sliding	•/•/-	-/•/-	•/•/-	-/-/•
LED Light/Daylight/Interior Light	•/-/-	•/-/-	•/•/-	-/-/•
Super Freeze	•	•	•	-
Big Box	•	•	•	-
Wine Cabinets	-	•	-	-
Vegetable Drawer	-	-	-	•
Manual Defrost	-	-	-	•

Cooling Functions

MULTIPLE COOLING SYSTEMS

Separate cooling circuits for independent temperature control, to prevent the transference of odours and/or humidity between the fridge and freezer cavities.



NO FROST

No Frost freezers automatically react to any signs of frost so it never has a chance to build up. With a No Frost freezer, air is blown from the back wall and circulates over food items. As a result, there is no condensation or build up of frost and food does not freeze together.



SUPER FREEZE

To stop already frozen food warming up just by being in the same drawers, the freezer temperature can be lowered in preparation. Super Freeze lowers the temperature temporarily before switching back automatically. Simply activate "Super Freeze" via the NEFF Home Connect app.

INTELLIGENT COOLING

Uses a range of innovative sensors to calculate the quantity of food in the fridge and the outside temperature. The fridge then adjusts the internal cooling power accordingly.

DOOR OPEN

Door Open and high temperature alarm systems alert if the door has been left open or a power cut has occurred. Ideal for mitigating food wastage.

DOOR OPEN ASSIST

Open the fridge with a simple push or a single word. The push to open mechanism is a perfect match with handle free kitchen furniture.



MULTI AIR FLOW COOLING

Greatly improves the circulation of air around the fridge, regulating the temperature and humidity levels and eradicating condensation build up, so that food stays fresher for longer.



LOW FROST

Low Frost improves performance and reduces frost build up in an energy efficient way. It also provides more storage space due to there being no internal evaporator. It also means the freezer is likely to only need defrosting every 2-3 years.



COOL AIRFLOW

Our Cool AirFlow system treats ingredients as lovingly as they were picked. Cool AirFlow circulates the air evenly in the fridge to keep flavours delicious under ideal cooling conditions.

SUPER COOL

Allows for the increase in temperature that occurs when fresh food is added. As soon as the food is cold, the fridge will readjust to the normal temperature.

FRESH SAFE

Our innovative 0°C Fresh Safe preservation system extends the life of food to reduce waste.

Design Features

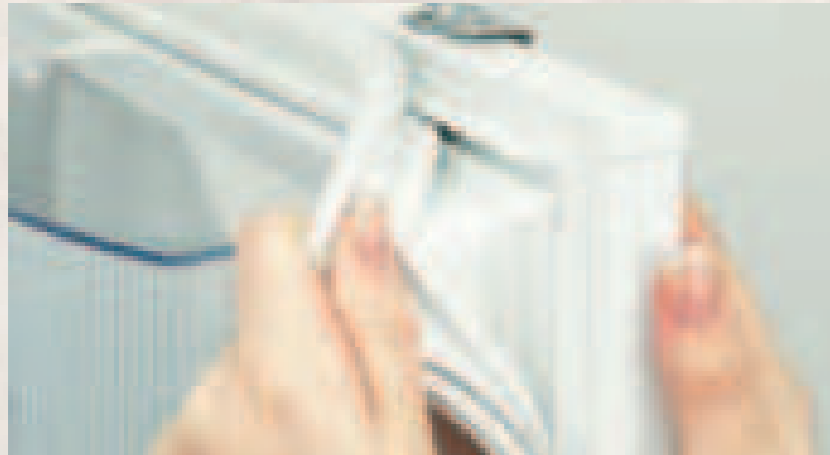

Unique to NEFF, making your life even easier

EASY CLEAN MAGNETIC DOOR SEALS

The magnetic door seals on all of our refrigeration ranges are removable, making them easy to clean and/or replace if necessary.

SOFT CLOSE

With Soft Close, the fridge door closes automatically when open at an angle of 20° or less. With a soft closing mechanism, it's the ideal addition to kitchens with soft close cabinets.

ANTI-SPILL TRIMS

Effectively hold up to a pint of liquid in case of accidental spillage. Food is protected below and the clean-up process is a little less messy.



WIRE SHELF

Completely unique to NEFF, our new Wire Shelf feature is ideal for securely storing jars and bottles stacked on their side.



EASY LIFT SHELF

With Easy Lift shelving, it's possible to adjust shelves with just one hand – even when they're fully loaded. Perfect when unloading shopping or introducing freshly prepared dishes to the fridge.

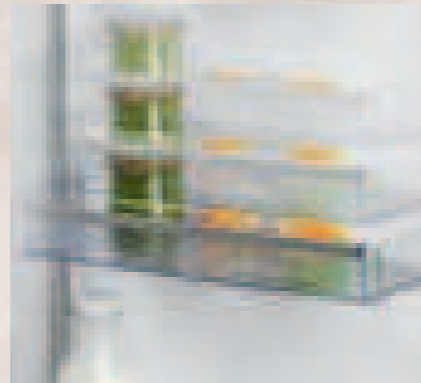

EASY LIFT DOOR STORAGE

Easily adjust door storage with just one hand. Combined with Easy Lift Shelves, the fridge space won't restrict what can be stored.



EASY ACCESS SHELF

The retractable glass shelf allows for easy loading and unloading as well as better access to the food. Ideal for putting the finishing touches to those delicate desserts.

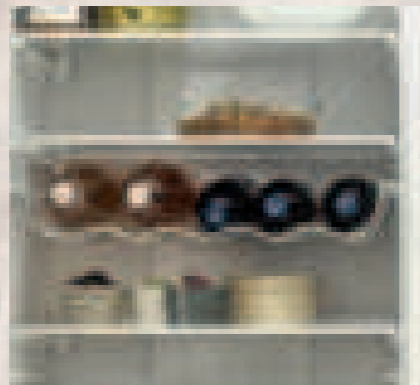

BOTTLE RACK

Always have a chilled bottle on standby for those impromptu get-togethers.

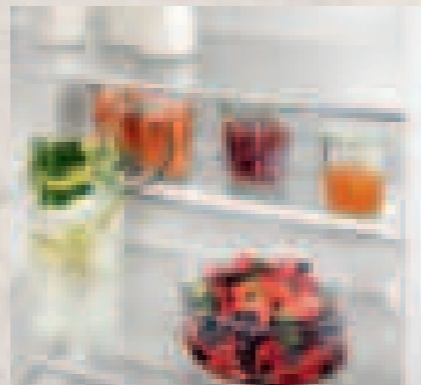

VARIO SHELF

Designed to offer complete flexibility in the fridge, sectioned glass shelves can simply be separated and slid underneath when not in use. Ideal for larger dishes, with space left over for a convenient condiments storage area at the back.



NEFF Home Connect



Home Connect

Simply use a smartphone or tablet to control your XXL fridge, even when on the go. Using the NEFF Home Connect app allows access to smart benefits, including controlling the fridge on the go and easily setting it to Eco or Holiday mode, even when no longer at home.

Individual Temperature Control

Tastes vary – and so do the ingredients. Individual Temperature Control enables temperature adjustment depending on what is being stored. Simply choose an eco-friendly mode with a higher temperature for the fridge via the electronic control panel, while the Individual Temperature Control keeps the freezer up and running.

Door Alarm

Say goodbye to the frustration of accidentally leaving the fridge door open. Equipped with both visual and acoustic alarms, the fridge signals that it needs another gentle shove for sustainable cooling. Even if the door is slightly ajar, the fridge will request a gentle nudge to maintain optimal temperatures. And for added convenience, if your fridge is integrated with the NEFF Home Connect app, you'll receive notifications directly to your smartphone.

Freezer Light

Our Freezer LED light illuminates every frozen ingredient in the drawers. And if the appliance is NEFF Home Connect enabled, the light can be adapted depending on preferences. Also, the emotion light can be activated which adds a lovely light effect to the kitchen even when the doors of the fridge and freezer are closed.

Fresh Safe <0°C>

Enjoy a variety of storage options to suit preferences, including a flexible drawer for fruits and vegetables. In addition, the unit features a dedicated compartment for meat and fish that's kept at an optimal temperature up to 0°C.



NEW Multi-door DESIGN



Introducing the New Multi Door Fridge Freezer to the NEFF range

A statement appliance that blends contemporary design with serious refrigeration performance. Finished in dark steel, it brings modern style to the kitchen while protecting ingredients with intelligent storage, precise cooling and low maintenance technology.

- **Design & capacity:** Dark steel finish and a wide, double door fridge opening create a sleek, contemporary look and plenty of room for large platters and big shopping trips.
- **Flexible, customised storage:** Adjustable shelves, removable drawers, split shelves and door bins – plus convertible compartments – let you rearrange the interior to suit shopping habits and oversized items.
- **Precise, multi zone cooling:** Dedicated temperature zones and multi airflow/twin cooling systems maintain optimal temps for different foods, deliver even cooling throughout the cabinet and cut odour transfer between compartments.
- **Bright, low maintenance operation:** Efficient LED lighting keeps the interior clearly illuminated, while no frost/auto defrost systems prevent ice build up and eliminate the need for manual defrosting.

NEW multi-door fridge freezer

Freestanding by design, built-in look

This freestanding fridge offers the flexibility of a standalone appliance with the clean, integrated appearance of a built-in. When sited within a run of cabinets and given the recommended ventilation and service clearances, it can sit flush with surrounding units for a seamless finish. For precise door-opening, ventilation and installation dimensions, please refer to the product line drawings and installation guide.



*25mm gap required at the back between the appliance and the back wall



Model shown: **KM3963XE0**

4 door

- **XXL capacity:** easily store your weekly shop
- **VitaFresh technology:** keep your fruit and veg fresh for longer
- **No Frost:** no more defrosting!
- **Super storage:** the freezer cavity comes with two No Frost Big Boxes – ideal for stacking meal prep containers

Instant refreshment with ice & water

There's nothing better on a hot day than a cold glass of filtered water and cubed or crushed ice for your drinks. That's why our multi doors with the quick ice & water dispenser gives you instant refreshment with up to 5kg ice within 24h - including a water filtration system. It also has a hands-free bottle filling function for water with adjustable filling height.

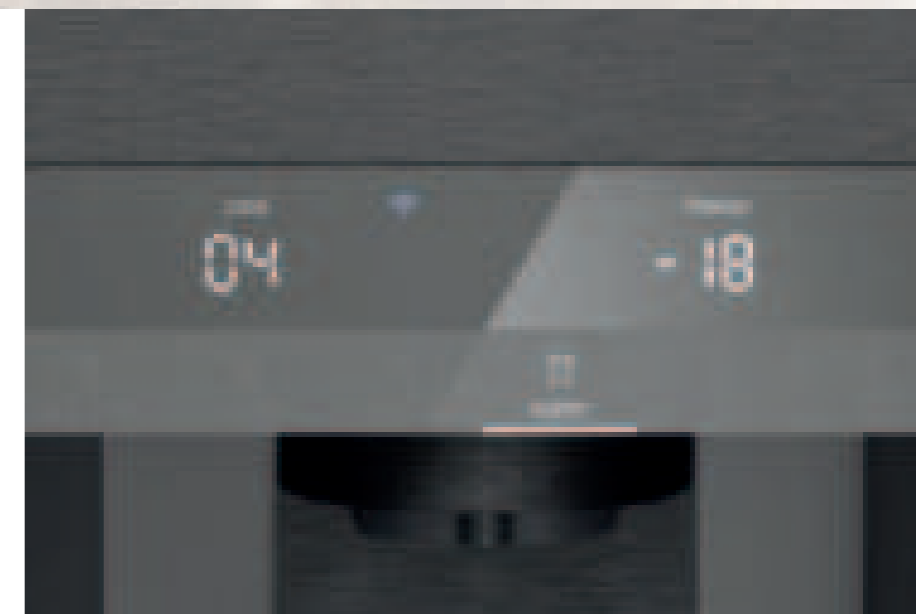

Built Under Wine Cabinets



KU9202HF0G | N70

- Holds 21 Wine Bottles
- LED Lighting
- 1 Temperature Zone
- Temp Range 5° - 20°C
- UV Filtered glass door

KU9213HG0G | N70

- Holds 44 Wine Bottles
- LED Lighting
- 2 Temperature Zones
- Temp Range 5° - 20°C
- UV Filtered glass door

DESIGN FEATURES		
Colour of door panels	Black	Black
Colour of side panels	Black	Black
Type of glass door	3 glass panels, UV-filtered	3 glass panels, UV-filtered
Door handle type	Vertical bar handle	Vertical bar handle
Temperature display	Interior / Digital LED	Interior / Digital LED
Reversible door, hinged on right	•	•
NEFF Home Connect / Built in cameras		
KEY FEATURES – WINE CABINET SECTION		
Range of temperature (0°C)	5 - 20	5 - 20
Temperature zones	1	2
LED light	LED	LED
Number of shelves	4	5
Number of bamboo shelves	3	3
Number of adjustable shelves		
Presenter shelf and lighting		
Capacity in 0.75l (Bordeaux bottles)	21	44
FUNCTIONS		
Door open warning signal/malfunction	•	•
Child lock	•	•
PERFORMANCE & CONSUMPTION		
Energy efficiency class		
Energy consumption ¹ kWh/annum	100	130
Refrigerator net capacity L	56	108
Climate Class ²	SN-ST	SN-ST
Sabbath Mode		
Noise level dB (A) re 1 pW	38	38
Noise level class	D	D
Height of product mm	818	818
Width of product mm	298	598
Depth of product mm	567	581

Please ensure adequate ventilation is provided in plinth to allow air flow.

¹ Actual energy consumption will depend on how the appliance is used and where it is located.
² Climate zone ST = designed to operate in ambient temperature of +16°C to 38°C.
 Climate zone SN = designed to operate in ambient temperature of +10°C to 32°C.

Freestanding Fridge Freezers



KA3923IE0G | N70

- Side by Side arrangement
- Brushed Steel Anti-fingerprint
- Automatic Ice & Water (Plumbed In)
- 2 Fresh Safe Drawers (Fridge)
- No Frost



KM3963XE0 | N70

- Multi door – Fridge Top / Freezer Bottom
- Black Inox Anti-fingerprint
- Automatic Ice & Water (Plumbed In)
- 2 Fresh Safe Drawers (Fridge)
- No Frost
- Configuration allows wider fridge space

DESIGN FEATURES		
Colour of door panels	Brushed Steel Anti-fingerprint	Black Inox Anti-fingerprint
Colour of sides	Grey	Cast Iron
Style of handle	Vertical bar handle	Integrated Handles
Colour of handle	Stainless steel	Black
NoFrost in fridge and freezer	•	•
NEFF Home Connect, Wi-Fi dongle included		•
FOOD FRESHNESS SYSTEM		
Fresh Safe	2 x Fresh Safe drawers on rails	2 x Fresh Safe drawers
KEY FEATURES – FRIDGE SECTION		
Product highlights	LED	LED
Super Cool	•	•
Type of control	Electronic	Electronic
Number of shelves	5	5
Number of adjustable shelves		4
Bottle shelves in fridge	•	Multi Purpose Shelf
Number of door bins / shelves	5	4
Temperature display	Digital	Digital
Warning signal door open	•	•
KEY FEATURES – FREEZER SECTION		
Door opened indicator	•	•
Super Freeze function	•	•
Temperature adjustable in freezer	•	•
Number of ice cube trays	Automatic ice cube maker	Automatic ice cube maker
Ice dispenser features	Crushed ice, ice cubes, water, water filter	Crushed ice, ice cubes, water, water filter
Number of freezer drawers	2	6
ADDITIONAL INFORMATION		
Energy efficiency class		
Energy consumption ¹ kWh/annum	324	327
Total net capacity L	562	574
Refrigerator net capacity L	371	375
Freezer net capacity L	191	199
Climate Class ²	SN-T	SN-T
Noise level dB (A) re 1 pW	42	39 dB
Noise level class	D	C
Sabbath mode		•
Additional accessories included	1 x connection hose	1 x connection hose
Height of product mm	1787	1830
Width of product mm	908	905
Depth of product mm	707	731

¹ Actual energy consumption will depend on how the appliance is used and where it is located.
² Climate zone SN = designed to operate in ambient temperature of +10°C to 32°C.
 Climate zone T = designed to operate in ambient temperature of +18°C to 43°C.

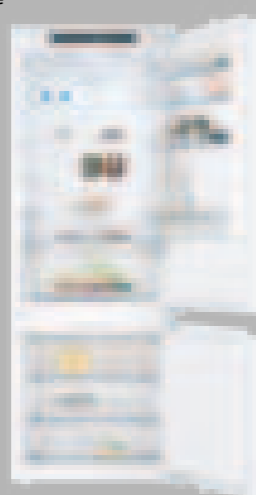
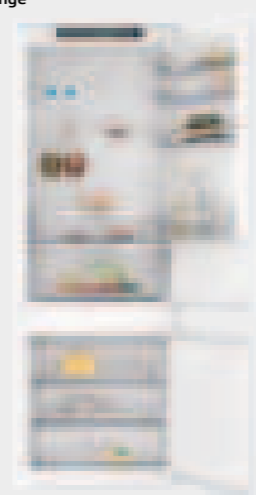
Built-In Fridge Freezers

	XXL 193.5CM TALL - 60/40	
	KB7966DD1G N70	KB7962SE0 N50
	<ul style="list-style-type: none"> • Extra Capacity • 2 Fresh Safe Drawers • No Frost • NEFF Home Connect • LED Lighting • Fixed Hinge 	<ul style="list-style-type: none"> • Extra Capacity • 2 Fresh Safe Drawer • No Frost • NEFF Home Connect • LED Lighting • Sliding Hinge 
DESIGN FEATURES		
Fridge / Freezer split	60/40	60/40
No Frost	•	•
Low Frost or Manual defrost		
Soft Close hinge		
Type of hinge (reversible)	Fixed hinge	Sliding hinge
NEFF Home Connect	•	•
FOOD FRESHNESS SYSTEM		
Fresh Safe	2 x Fresh Safe drawers	2 x Fresh Safe drawers
KEY FEATURES – FRIDGE SECTION		
Light	LED	LED
Super Cool function	•	•
Type of control	Electronic	Electronic
Number of shelves	5	5
Number of adjustable shelves	4	4
Number of door bins / shelves	7	7
Type of shelves	Safety glass	Safety glass
Temperature display	Digital LED	Digital LED
Warning signal door open	•	•
Bottle shelves in fridge	•	•
KEY FEATURES – FREEZER SECTION		
Super Freeze function	•	•
Temperature adjustable in freezer	•	•
Number of ice cube trays	1	1
Number of freezer drawers	3	3
ADDITIONAL INFORMATION		
Energy efficiency class		
Energy consumption ¹	kWh/annum 204	256
Total net capacity	L 381	383
Refrigerator net capacity	L 283	285
Freezer net capacity	L 98	98
Climate class ²	SN-ST	SN-ST
Noise level	dB (A) re 1 pW 33	34
Noise level class	B	B
Sabbath Mode	•	•
Additional accessories included	1 x ice cube tray, 1 x bottle holder/wire rack	1 x ice cube tray, 1 x bottle holder/wire rack
Height of product	mm 1935	1935
Width of product	mm 708	691
Depth of product	mm 548	548

	XL 193.5CM TALL - 60/40	
	KI7962FD0G N50	KI7961SE0G N30
	<ul style="list-style-type: none"> • Extra Capacity • 2 Fresh Safe Drawers • No Frost • LED Lighting • Fixed Hinge 	<ul style="list-style-type: none"> • Extra Capacity • 1 Fresh Safe Drawer • No Frost • LED Lighting • Sliding Hinge 
DESIGN FEATURES		
Fridge / Freezer split	60/40	60/40
No Frost	•	•
Low Frost or Manual defrost		
Soft Close hinge		
Type of hinge (reversible)	Fixed hinge	Sliding hinge
NEFF Home Connect		
FOOD FRESHNESS SYSTEM		
Fresh Safe	2 x Fresh Safe drawers	1 x Fresh Safe drawer
KEY FEATURES – FRIDGE SECTION		
Light	LED	LED
Super Cool function		•
Type of control	Electronic	Electronic
Number of shelves	3	4
Number of adjustable shelves	3	4
Number of door bins / shelves	4	4
Type of shelves	Safety glass	Safety glass
Temperature display	Digital LED	Digital LED
Warning signal door open	•	•
Bottle shelves in fridge	•	
KEY FEATURES – FREEZER SECTION		
Super Freeze function	•	•
Temperature adjustable in freezer		•
Number of ice cube trays	1	1
Number of freezer drawers	3	3
ADDITIONAL INFORMATION		
Energy efficiency class		
Energy consumption ¹	kWh/annum 184	231
Total net capacity	L 290	290
Refrigerator net capacity	L 215	215
Freezer net capacity	L 75	75
Climate class ²	SN-ST	SN-ST
Noise level	dB (A) re 1 pW 34	34
Noise level class	B	B
Sabbath Mode	•	•
Additional accessories included	1 x ice cube tray, 1 x bottle holder/wire rack	1 x ice cube tray
Height of product	mm 1935	1935
Width of product	mm 558	541
Depth of product	mm 548	548

¹ Actual energy consumption will depend on how the appliance is used and where it is located.
² Climate zone SN = designed to operate in ambient temperature of +10°C to 32°C.
 Climate zone T = designed to operate in ambient temperature of +18°C to 43°C.

Built-In Fridge Freezers

177CM TALL - 70/30



- 1 Fresh Safe Drawer
- Low Frost

- Fixed Hinge

- 1 Fresh Safe Drawer
- Low Frost

- Fixed Hinge

DESIGN FEATURES	KI6873FE0G N70	KI5872FE0G N50
Fridge / Freezer split	70/30	70/30
No Frost		
Low Frost or Manual defrost	Low Frost	Low Frost
Soft Close hinge		
Type of hinge (reversible)	Fixed hinge	Fixed hinge
NEFF Home Connect		
FOOD FRESHNESS SYSTEM		
Fresh Safe	1 x Fresh Safe drawer	1 x Fresh Safe drawer
KEY FEATURES – FRIDGE SECTION		
Light	LED	LED
Super Cool function	•	
Type of control	Electronic	Electronic
Number of shelves	5	5
Number of adjustable shelves	4	4
Number of door bins / shelves	5	4
Type of shelves	Safety glass	Safety glass
Temperature display	Digital LED	Digital LED
Warning signal door open	•	•
Bottle shelves in fridge	•	
KEY FEATURES – FREEZER SECTION		
Super Freeze function	•	•
Temperature adjustable in freezer	•	
Number of ice cube trays	1	1
Number of freezer drawers	2	2
ADDITIONAL INFORMATION		
Energy efficiency class		
Energy consumption ¹ kWh/annum	207	216
Total net capacity L	272	270
Refrigerator net capacity L	209	200
Freezer net capacity L	63	70
Climate class ²	SN-T	SN-ST
Noise level dB(A) re 1 pW	36	35
Noise level class	C	B
Additional accessories included	1 x ice cube tray, 1 x bottle holder in door tray	1 x ice cube tray
Height of product mm	1772	1772
Width of product mm	558	541
Depth of product mm	545	545

177CM TALL - 70/30

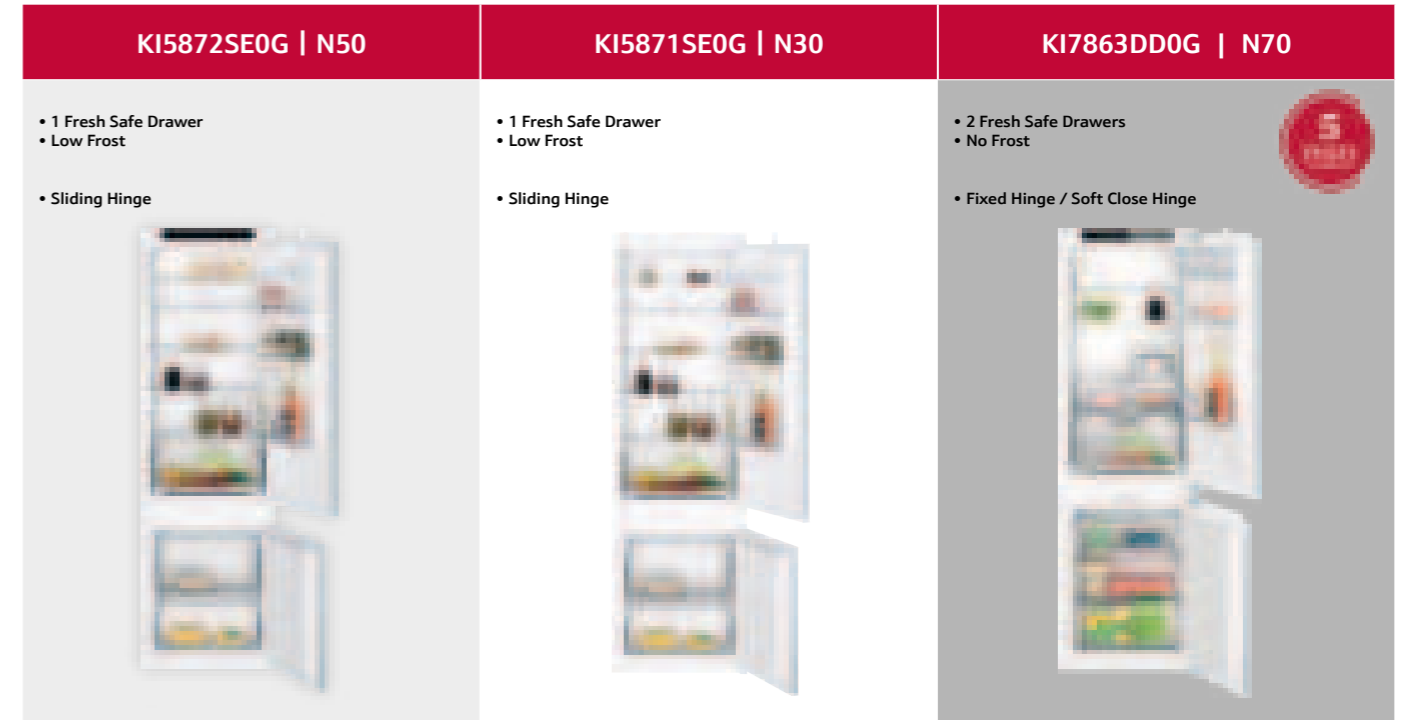

- 1 Fresh Safe Drawer
- Low Frost

- Sliding Hinge

- 1 Fresh Safe Drawer
- Low Frost

- Sliding Hinge

- 2 Fresh Safe Drawers
- No Frost

- Fixed Hinge / Soft Close Hinge

DESIGN FEATURES	KI5872SE0G N50	KI5871SE0G N30	KI7863DD0G N70
Fridge / Freezer split	70/30	70/30	60/40
No Frost			•
Low Frost or Manual defrost	Low Frost	Low Frost	
Soft Close hinge			•
Type of hinge (reversible)	Sliding hinge	Sliding hinge	Fixed hinge
NEFF Home Connect			
FOOD FRESHNESS SYSTEM			
Fresh Safe	1 x Fresh Safe drawer	1 x Fresh Safe drawer	2 x Fresh Safe drawers
KEY FEATURES – FRIDGE SECTION			
Light	LED	LED	LED
Super Cool function	•	•	•
Type of control	Electronic	Electronic	Electronic
Number of shelves	5	5	3
Number of adjustable shelves	4	5	1
Number of door bins / shelves	4	4	4
Type of shelves	Safety glass	Safety glass	Safety glass
Temperature display	Digital LED	Digital LED	Digital LED
Warning signal door open	•	•	•
Bottle shelves in fridge	•	•	•
KEY FEATURES – FREEZER SECTION			
Super Freeze function	•	•	•
Temperature adjustable in freezer	•	•	•
Number of ice cube trays	1	1	1
Number of freezer drawers	2	2	3
ADDITIONAL INFORMATION			
Energy efficiency class			
Energy consumption ¹ kWh/annum	216	216	186
Total net capacity L	270	270	260
Refrigerator net capacity L	200	200	184
Freezer net capacity L	70	70	76
Climate class ²	SN-ST	SN-ST	SN-ST
Noise level dB(A) re 1 pW	35	35	35
Noise level class	B	B	B
Additional accessories included	1 x ice cube tray	1 x ice cube tray	1 x ice cube tray, 1 x bottle holder/wire rack
Height of product mm	1772	1772	1772
Width of product mm	541	541	558
Depth of product mm	545	548	548

¹ Actual energy consumption will depend on how the appliance is used and where it is located.
² Climate zone SN = designed to operate in ambient temperature of +10°C to 32°C.
 Climate zone T = designed to operate in ambient temperature of +18°C to 43°C.

Built-In Fridge Freezers

177CM TALL - 60/40

KI7862FE0G N50	KI7862SE0G N50	KI5862SE0G N50
<ul style="list-style-type: none"> • 2 Fresh Safe Drawers • No Frost 	<ul style="list-style-type: none"> • 2 Fresh Safe Drawers • No Frost 	<ul style="list-style-type: none"> • 1 Fresh Safe Drawer • Low Frost
<ul style="list-style-type: none"> • Fixed Hinge 	<ul style="list-style-type: none"> • Sliding Hinge 	<ul style="list-style-type: none"> • Sliding Hinge

DESIGN FEATURES			
Fridge / Freezer split	60/40	60/40	60/40
No Frost	•	•	
Low Frost or Manual defrost			Low Frost
Soft Close hinge			
Type of hinge (reversible)	Fixed hinge	Sliding hinge	Sliding hinge
NEFF Home Connect			
FOOD FRESHNESS SYSTEM			
Fresh Safe	2 x Fresh Safe drawers	2 x Fresh Safe drawers	1 x Fresh Safe drawer
KEY FEATURES – FRIDGE SECTION			
Light	LED	LED	LED
Super Cool function	•	•	•
Type of control	Electronic	Electronic	Electronic
Number of shelves	3	3	4
Number of adjustable shelves	3	3	3
Number of door bins / shelves	4	4	4
Type of shelves	Safety glass	Safety glass	Safety glass
Temperature display	Digital LED	Digital LED	Digital LED
Warning signal door open	•	•	•
Bottle shelves in fridge	•	•	•
KEY FEATURES – FREEZER SECTION			
Super Freeze function	•	•	•
Temperature adjustable in freezer			
Number of ice cube trays	1	1	1
Number of freezer drawers	3	3	3
ADDITIONAL INFORMATION			
Energy efficiency class			
Energy consumption ¹ kWh/annum	234	234	229
Total net capacity L	260	260	269
Refrigerator net capacity L	184	184	184
Freezer net capacity L	76	76	85
Climate class ²	SN-ST	SN-ST	SN-ST
Noise level dB(A) re 1 pW	35	35	35
Noise level class	B	B	B
Additional accessories included	1 x ice cube tray, 1 x bottle holder/wire rack	1 x ice cube tray 1 x bottle holder/wire rack	1 x ice cube tray
Height of product mm	1772	1772	1772
Width of product mm	541	541	541
Depth of product mm	548	548	545

177CM TALL - 60/40 177CM TALL - 50/50

KI7861FE0G N30	KI7861SE0G N30	KI7851FE0G N30	KI7851SE0G N30
<ul style="list-style-type: none"> • 1 Fresh Safe Drawer • No Frost 	<ul style="list-style-type: none"> • 1 Fresh Safe Drawer • No Frost 	<ul style="list-style-type: none"> • 1 Fresh Safe Drawer • No Frost 	<ul style="list-style-type: none"> • 1 Fresh Safe Drawer • No Frost
<ul style="list-style-type: none"> • Fixed Hinge 	<ul style="list-style-type: none"> • Sliding Hinge 	<ul style="list-style-type: none"> • Fixed Hinge 	<ul style="list-style-type: none"> • Sliding Hinge

DESIGN FEATURES			
Fridge / Freezer split	60/40	60/40	50/50
No Frost	•	•	•
Low Frost or Manual defrost			Low Frost
Soft Close hinge			
Type of hinge (reversible)	Fixed hinge	Sliding hinge	Fixed hinge
NEFF Home Connect			
FOOD FRESHNESS SYSTEM			
Fresh Safe	1 x Fresh Safe drawer	1 x Fresh Safe drawer	1 x Fresh Safe drawer
KEY FEATURES – FRIDGE SECTION			
Light	LED	LED	LED
Super Cool function	•	•	•
Type of control	Electronic	Electronic	Electronic
Number of shelves	4	4	3
Number of adjustable shelves	3	3	2
Number of door bins / shelves	3	3	2
Type of shelves	Safety glass	Safety glass	Safety glass
Temperature display	Digital LED	Digital LED	Digital LED
Warning signal door open	•	•	•
Bottle shelves in fridge	•	•	•
KEY FEATURES – FREEZER SECTION			
Super Freeze function	•	•	•
Temperature adjustable in freezer			
Number of ice cube trays	1	1	1
Number of freezer drawers	3	3	4
ADDITIONAL INFORMATION			
Energy efficiency class			
Energy consumption ¹ kWh/annum	234	234	239
Total net capacity L	260	260	249
Refrigerator net capacity L	184	184	150
Freezer net capacity L	76	76	99
Climate class ²	SN-ST	SN-ST	SN-ST
Noise level dB(A) re 1 pW	35	35	39
Noise level class	B	B	C
Additional accessories included	1 x ice cube tray	1 x ice cube tray	1 x ice cube tray
Height of product mm	1772	1772	1772
Width of product mm	541	541	541
Depth of product mm	548	548	548

¹ Actual energy consumption will depend on how the appliance is used and where it is located.
² Climate zone SN = designed to operate in ambient temperature of +10°C to 32°C.
 Climate zone T = designed to operate in ambient temperature of +18°C to 43°C.

Built-In Single Door Fridges & Freezers

177CM TALL FRIDGES

KI8815OD0G N90	KI1813FE0G N70	KI2822FE0G N50	KI1812FE0G N50
<ul style="list-style-type: none"> • 3 x Fresh Safe drawers • NEFF Home Connect • Fixed hinge / Soft Close Hinge • Door Open Assist • Alexa Voice Controlled 	<ul style="list-style-type: none"> • 2 x Fresh Safe drawers • Fixed hinge 	<ul style="list-style-type: none"> • 2 x Fresh Safe drawers • Low Frost • Fixed hinge 	<ul style="list-style-type: none"> • 2 x Fresh Safe drawers • Fixed hinge

DESIGN FEATURES				
No Frost				
Low Frost or Manual defrost			•	
Soft Close hinge	•			
Type of hinge (reversible)	Fixed hinge	Fixed hinge	Fixed hinge	Fixed hinge
NEFF Home Connect	•			
FOOD FRESHNESS SYSTEM				
Fresh Safe	3 x Fresh Safe drawers	2 x Fresh Safe drawers	2 x Fresh Safe drawers	2 x Fresh Safe drawers
KEY FEATURES – FRIDGE SECTION				
Light	LED	LED	LED	LED
Super Cool function	•	•	•	•
Type of control	Electronic	Electronic	Electronic	Electronic
Number of shelves	7	7	4	6
Number of adjustable shelves	5	6	4	6
Number of door bins / shelves	6	6	5	5
Type of shelves	Safety glass	Safety glass	Safety glass	Safety glass
Temperature display	Digital LED	Digital LED	Digital LED	Digital LED
Warning signal door open	•	•	•	•
Bottle shelves in fridge	•	•	•	•
KEY FEATURES – FREEZER SECTION				
Super Freeze function				
Temperature adjustable in freezer				
Number of ice cube trays			1	
Number of freezer drawers				
ADDITIONAL INFORMATION				
Energy efficiency class	A D	A E	A E	A E
Energy consumption ¹ kWh/annum	120	115	177	114
Total net capacity L	289	319	280	310
Freezer net capacity L			34	
Climate class ²	SN-T	SN-T	SN-ST	SN-ST
Noise level dB(A) re 1 pW	36	37	35	35
Noise level class	C	C	B	B
Additional accessories included	1 x bottle flex shelf		1 x ice cube tray	1 x bottle flex shelf
Height of product mm	1772	1772	1772	1772
Width of product mm	558	558	541	541
Depth of product mm	545	545	548	548
GB Plug	•			

177CM TALL FRIDGES

177CM TALL FREEZERS

KI1811SE0G N30	GI7815NE0 N90	GI7815CE0G N90	GI7812EE0G N50
<ul style="list-style-type: none"> • 2 x Fresh Safe drawers • Sliding Hinge 	<ul style="list-style-type: none"> • No Frost • NEFF Home Connect • Fixed hinge/Soft Close Hinge • Door Open Assist • Alexa Voice Controlled 	<ul style="list-style-type: none"> • No Frost • NEFF Home Connect • Fixed hinge/Soft Close Hinge 	<ul style="list-style-type: none"> • No Frost • Fixed hinge

DESIGN FEATURES				
No Frost		•	•	•
Low Frost or Manual defrost				
Soft Close hinge		•	•	
Type of hinge (reversible)	Sliding hinge	Fixed hinge	Fixed hinge	Fixed hinge
NEFF Home Connect		•	•	
FOOD FRESHNESS SYSTEM				
Fresh Safe	2 x Fresh Safe drawers			
KEY FEATURES – FRIDGE SECTION				
Light	LED			
Super Cool function	•			
Type of control	Electronic			
Number of shelves	6			
Number of adjustable shelves	5			
Number of door bins / shelves	5			
Type of shelves	Safety glass			
Temperature display	Digital LED			
Warning signal door open	•			
Bottle shelves in fridge	•			
KEY FEATURES – FREEZER SECTION				
Super Freeze function		•	•	•
Temperature adjustable in freezer		•	•	•
Number of ice cube trays		1	1	1
Number of freezer drawers		5	5	5
ADDITIONAL INFORMATION				
Energy efficiency class	A E	A E	A E	A E
Energy consumption ¹ kWh/annum	114	235	235	235
Total net capacity L	310	212	212	212
Freezer net capacity L		212	212	212
Climate class ²	SN-ST	SN-T	SN-T	SN-T
Noise level dB(A) re 1 pW	35	35	35	35
Noise level class	B	B	B	B
Additional accessories included		1 x ice cube tray	1 x ice cube tray	1 x ice cube tray
Height of product mm	1772	1772	1772	1772
Width of product mm	541	558	558	558
Depth of product mm	548	545	545	545

¹ Actual energy consumption will depend on how the appliance is used and where it is located.
² Climate zone SN = designed to operate in ambient temperature of +10°C to 32°C.
 Climate zone T = designed to operate in ambient temperature of +18°C to 43°C.

Built-in Single Door Fridges & Freezers

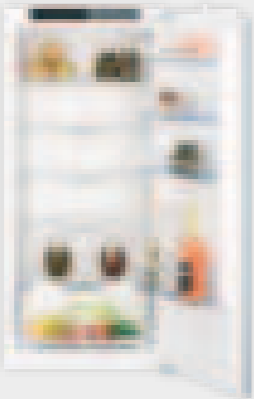
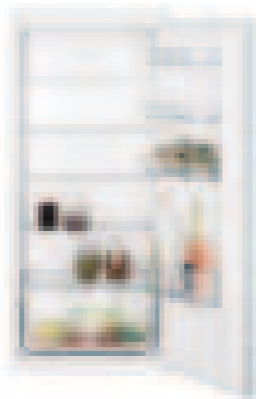
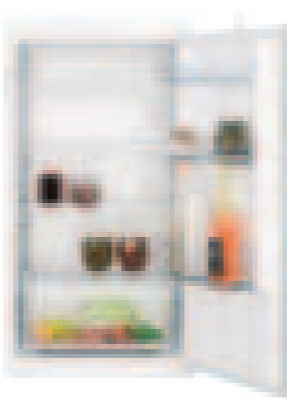
	122CM TALL FRIDGES	102CM TALL FRIDGE	
	KI1412FE1G N50	KI1411SE0G N30	KI1311SE0 N30 DISCONTINUING OCTOBER 2026
	<ul style="list-style-type: none"> • 1 x Fresh Safe drawer • Fixed hinge 	<ul style="list-style-type: none"> • 1 x Fresh Safe drawer • Sliding hinge 	<ul style="list-style-type: none"> • 1 x Fresh Safe drawer • Sliding hinge 
DESIGN FEATURES			
No Frost			
Low Frost or Manual defrost			
Soft Close hinge			
Type of hinge (reversible)	Fixed hinge	Sliding hinge	Sliding hinge
NEFF Home Connect			
FOOD FRESHNESS SYSTEM			
Fresh Safe	1 x Fresh Safe drawer	1 x Fresh Safe drawer	1 x Fresh Safe drawer
KEY FEATURES – FRIDGE SECTION			
Light	LED	LED	LED
Super Cool function	•	•	•
Type of control	Electronic	Electronic	Electronic
Number of shelves	5	5	4
Number of adjustable shelves	4	4	4
Number of door bins / shelves	4	4	3
Type of shelves	Safety glass	Safety glass	Safety glass
Temperature display	digital LED	digital LED	Digital LED
Warning signal door open	•	•	•
Bottle shelves in fridge	•		
KEY FEATURES – FREEZER SECTION			
Super Freeze function			
Temperature adjustable in freezer			
Number of ice cube trays			
Number of freezer drawers			
ADDITIONAL INFORMATION			
Energy efficiency class			
Energy consumption ¹ kWh/annum	101	101	96
Total net capacity L	204	204	165
Freezer net capacity L			
Climate class ²	SN-ST	SN-ST	SN-ST
Noise level dB(A) re 1 pW	35	35	35
Noise level class	B	B	B
Additional accessories included	1 x bottle rack/wire shelf		
Height of product mm	1221	1221	1021
Width of product mm	541	541	541
Depth of product mm	548	548	548

	88CM TALL FRIDGE	88CM TALL FREEZER	
	KI1212FE0 N50	KI1211SE0 N30 DISCONTINUING OCTOBER 2026	GI1216DE0 N50
	<ul style="list-style-type: none"> • 1 x Fresh Safe drawer • Fixed hinge 	<ul style="list-style-type: none"> • 1 x Fresh Safe drawer • Sliding hinge 	<ul style="list-style-type: none"> • Low Frost • Fixed hinge / Soft Close Hinge 
DESIGN FEATURES			
No Frost			
Low Frost or Manual defrost			
Soft Close hinge			
Type of hinge (reversible)	Fixed hinge	Sliding hinge	Fixed hinge
NEFF Home Connect			
FOOD FRESHNESS SYSTEM			
Fresh Safe	1 x Fresh Safe drawer	1 x Fresh Safe drawer	
KEY FEATURES – FRIDGE SECTION			
Light	LED	LED	
Super Cool function	•	•	
Type of control	Electronic	Electronic	
Number of shelves	3	3	
Number of adjustable shelves	2	2	
Number of door bins / shelves	2	2	
Type of shelves	Safety glass	Safety glass	
Temperature display	Digital LED	Digital LED	
Warning signal door open	•	•	
Bottle shelves in fridge	•		
KEY FEATURES – FREEZER SECTION			
Super Freeze function			
Temperature adjustable in freezer			
Number of ice cube trays			1
Number of freezer drawers			3
ADDITIONAL INFORMATION			
Energy efficiency class			
Energy consumption ¹ kWh/annum	92	92	176
Total net capacity L	136	136	96
Freezer net capacity L			96
Climate class ²	SN-ST	SN-ST	SN-T
Noise level dB(A) re 1 pW	35	35	36
Noise level class	B	B	C
Additional accessories included	1 x bottle rack/wire shelf		1 x ice cube tray
Height of product mm	874	874	874
Width of product mm	541	541	558
Depth of product mm	548	542	545

¹ Actual energy consumption will depend on how the appliance is used and where it is located.
² Climate zone SN = designed to operate in ambient temperature of +10°C to 32°C.
 Climate zone T = designed to operate in ambient temperature of +18°C to 43°C.

Built-Under Single Door Fridges & Freezer

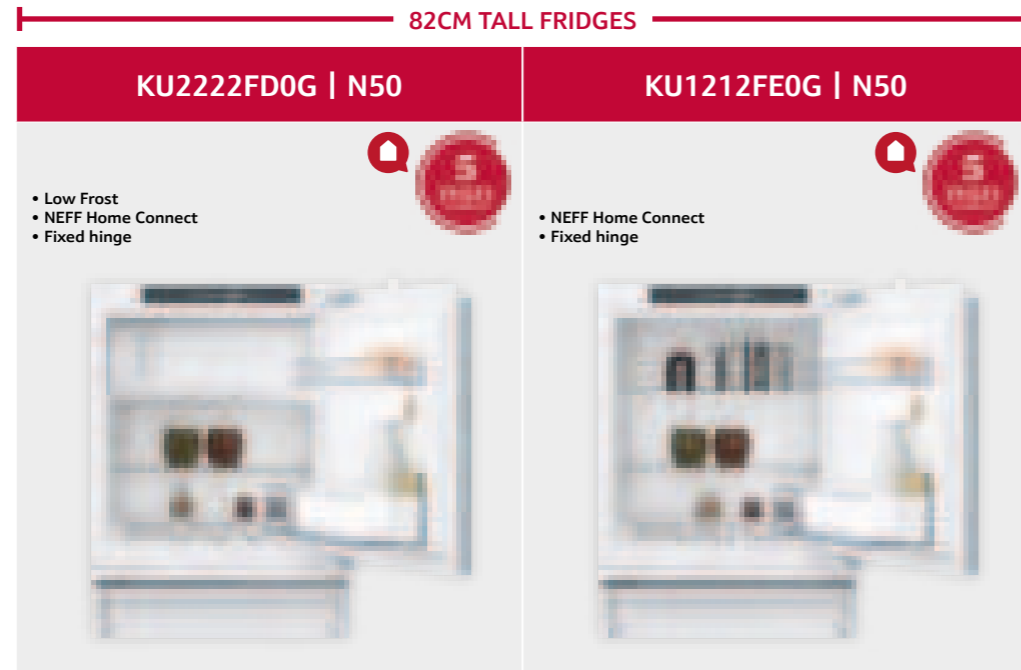

DESIGN FEATURES		
No Frost		
Low Frost or Manual defrost	•	
Soft Close hinge		
Type of hinge (reversible)	Fixed hinge	Fixed hinge
NEFF Home Connect	•	•
FOOD FRESHNESS SYSTEM		
Fresh Safe		
KEY FEATURES – FRIDGE SECTION		
Light	LED	LED
Super Cool	•	•
Type of control	Electronic	Electronic
Number of shelves	3	3
Number of adjustable shelves	2	3
Number of door bins / shelves	3	2
Type of shelves	Safety glass	Safety glass
Temperature display	Digital LED	Digital LED
Warning signal door open	•	•
Bottle shelves in fridge		
KEY FEATURES – FREEZER SECTION		
Super Freeze function		
Temperature adjustable in freezer		
Number of ice cube trays	1	
Number of freezer drawers		
ADDITIONAL INFORMATION		
Energy efficiency class	A D	A E
Energy consumption ¹ kWh/annum	119	93
Total net capacity L	110	134
Freezer net capacity L	17	
Climate class ²	SN-T	SN-T
Noise level dB(A) re 1 pW	35	35
Noise level class	B	B
Sabbath Mode	•	•
Additional accessories included		
Height of product mm	820	820
Width of product mm	598	598
Depth of product mm	548	548

	•	
	Fixed hinge	Fixed hinge
	•	
KEY FEATURES – FREEZER SECTION		
Super Freeze function		
Temperature adjustable in freezer		
Number of ice cube trays	1	1
Number of freezer drawers	3	3
ADDITIONAL INFORMATION		
Energy efficiency class	A E	A E
Energy consumption ¹ kWh/annum	189	167
Total net capacity L	85	72
Freezer net capacity L		72
Climate class ²	SN-T	SN-T
Noise level dB(A) re 1 pW	35	36
Noise level class	B	C
Sabbath Mode	•	
Additional accessories included	1 x ice cube tray	1 x ice cube tray
Height of product mm	820	712
Width of product mm	598	558
Depth of product mm	548	545

¹ Actual energy consumption will depend on how the appliance is used and where it is located.
² Climate zone SN = designed to operate in ambient temperature of +10°C to 32°C.
 Climate zone T = designed to operate in ambient temperature of +18°C to 43°C.

XXL & XL Built-In Fridge Freezers

XXL
193.5CM TALL
60/40 SPLIT
SOFT CLOSE HINGE
 KB7966DD1G

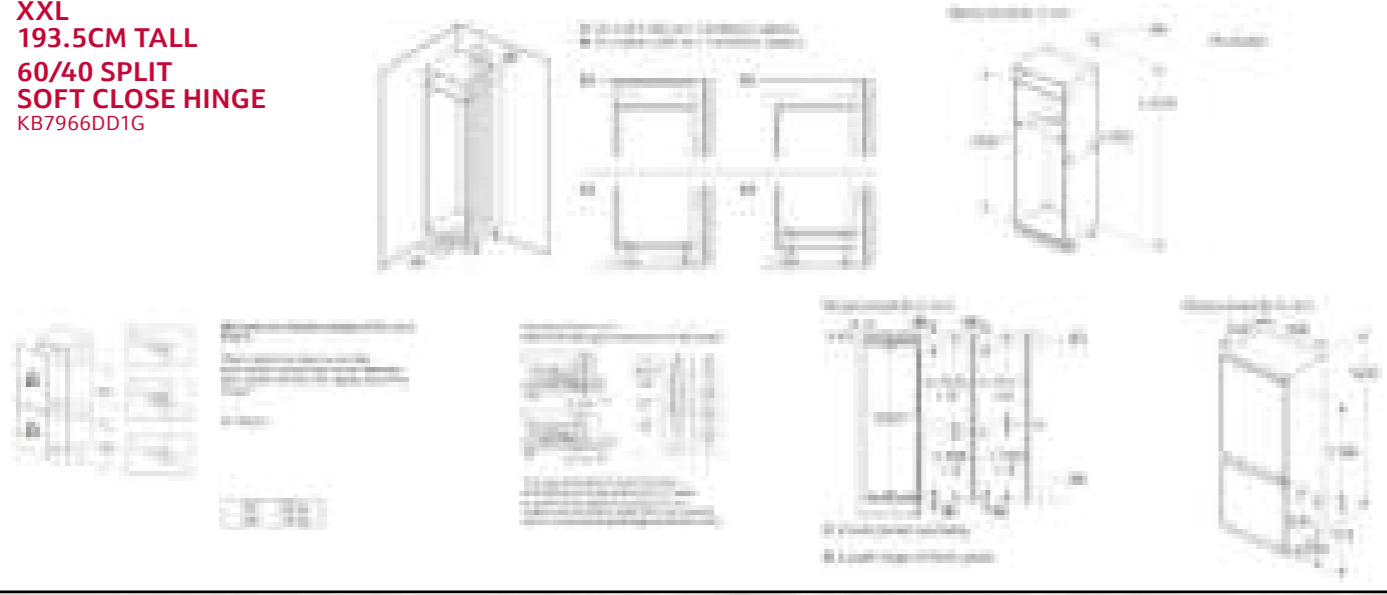

XL
193.5CM TALL
60/40 SPLIT
FIXED HINGE
 KI7962FD0G

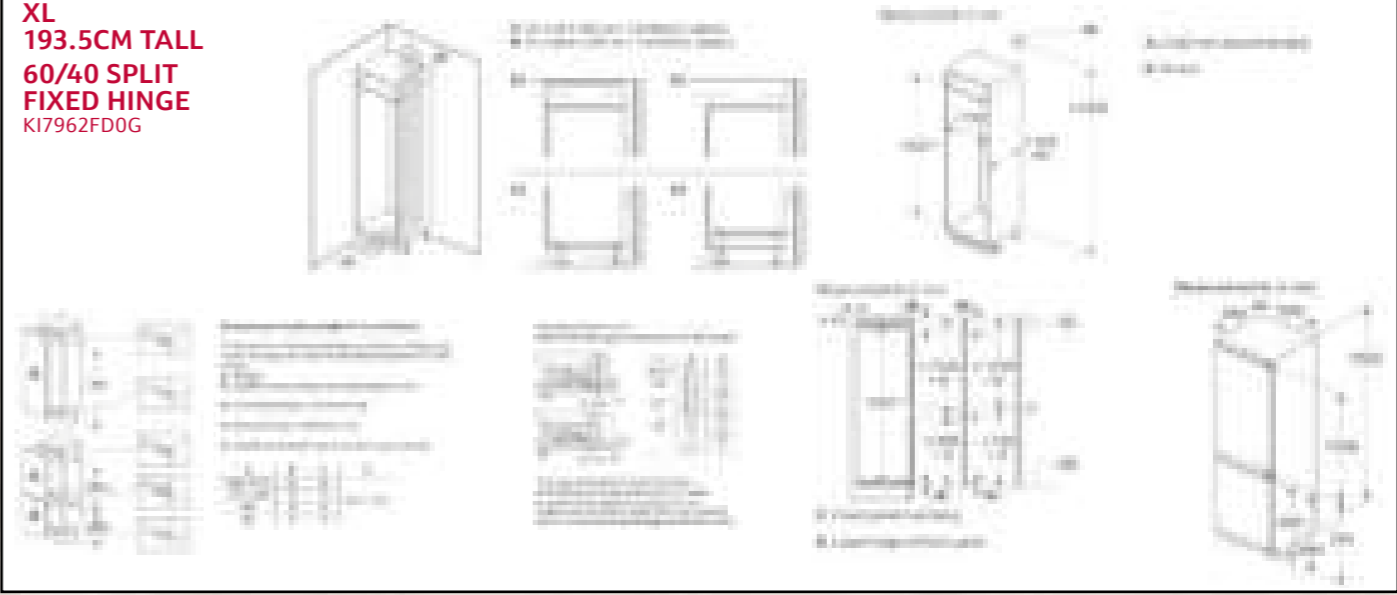

XXL
193.5CM TALL
60/40 SPLIT
SLIDING HINGE
 KB7962SE0

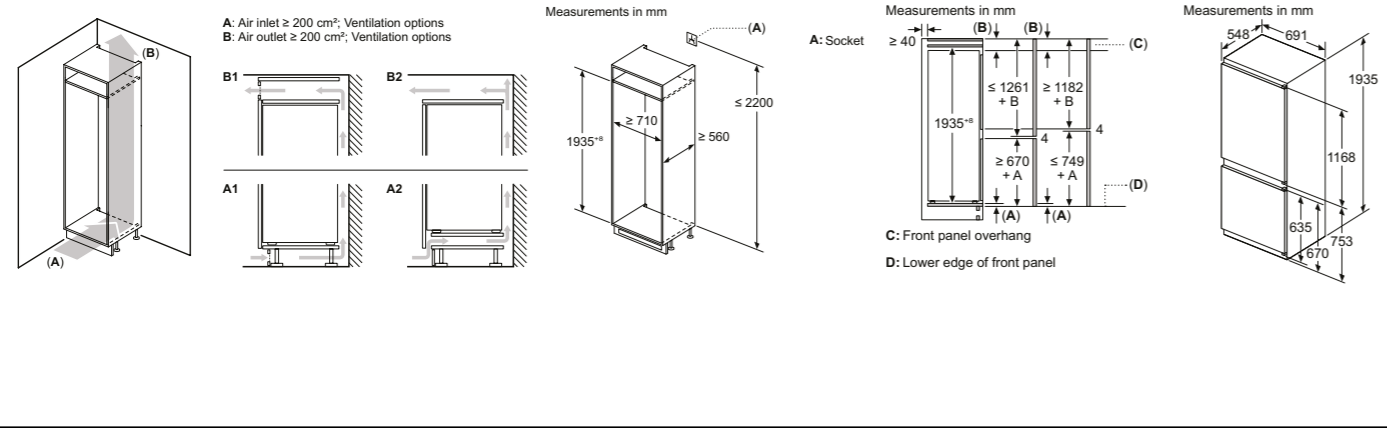

XL
193.5CM TALL
60/40 SPLIT
SLIDING HINGE
 KI7961SE0G

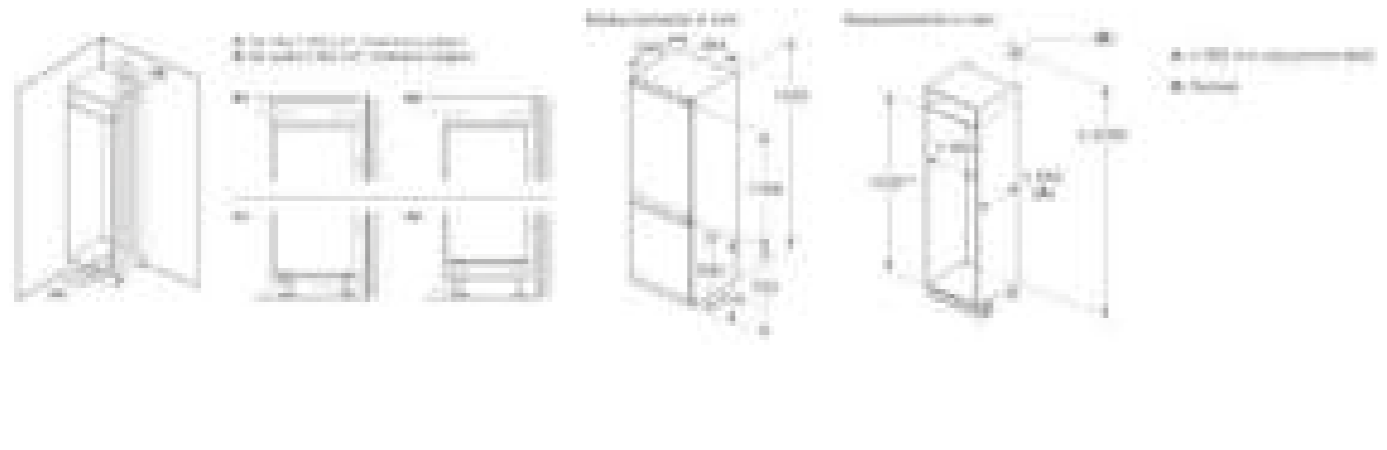

Built Under Wine Cabinets

30CM WIDE
 KU9202HF0G



60CM WIDE
 KU9213HG0G

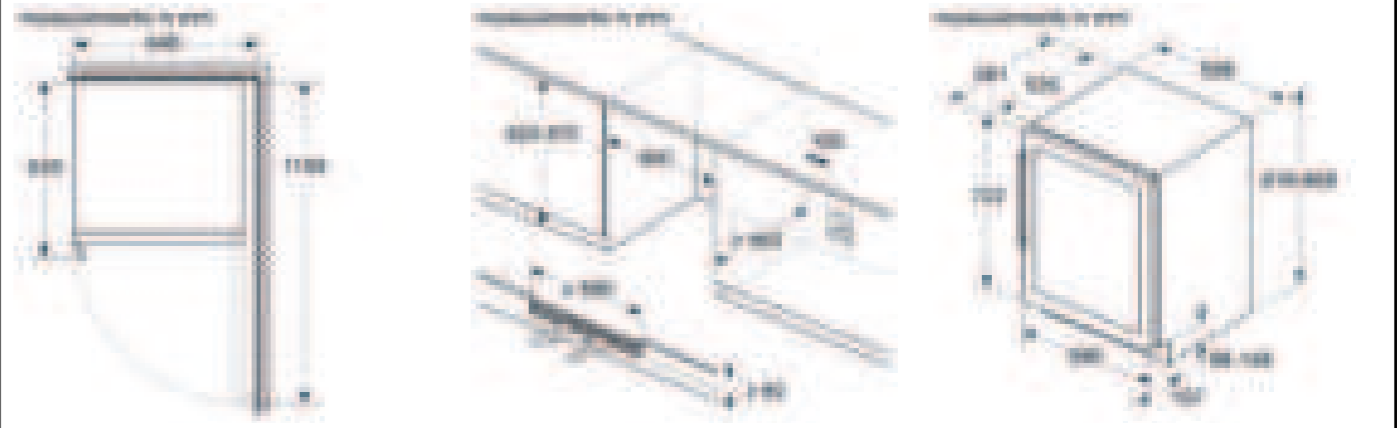

Measurements in mm. The line drawings featured in this brochure are provided as a guide to general dimensions only and are subject to amendment without prior notice. For full dimensional and installation details please refer to the documentation supplied with the appliance.

Freestanding Fridge Freezers

SIDE BY SIDE
KA3923IE0G

Specifications

A	Front is adjustable from 1783 to 1792		
B	Cabinet depth		
C	Depth incl. door, without handle		
D	Depth incl. door, with handle		
E	Water connection to the appliance		

x 1 (unit depth)	a	b
	600	0
	650	20
	700	20
x 2 (wall)		76

*25mm gap required at the back between the appliance and the back wall

MULTI DOOR
KA3923IE0G

Specifications

- A: Front is adjustable 1830-1847 mm, with front levelling feet fully extended
- B: April 20 mm for hand spacers on both
- C: Water connection position

Installation Explained

A ≤ 600 mm	600 < A ≤ 650 mm	650 < A ≤ 700 mm	A > 700 mm
If the Cabinet/Furniture or wall depth on either side of the appliance is 600 mm or less, no gap is required on either side of the appliance.	If the (A) Cabinet/Furniture or wall depth on either side of the appliance is between 600 mm – 650 mm a gap of (B) 45 mm is required on either side of the appliance.	If the (A) Cabinet/Furniture or wall depth on either side of the appliance is between 650 mm – 700 mm a gap of (B) 60 mm is required on either side of the appliance.	If the (A) Cabinet/Furniture or wall depth on either side of the appliance is larger than 700 mm a gap of (B) 239 mm is required on either side of the appliance.
The drawers and the shelves will open at 90° angle.	The drawers and the shelves will open at 90° angle.	The drawers and the shelves will open at 90° angle.	The drawers and the shelves will open at 90° angle.
Dimensions shown are the maximum depth with the doors open 1102 mm & the maximum width with 1383 mm.	Dimensions shown are the maximum depth with the doors open 1102 mm & the maximum width with 1383 mm.	Dimensions shown are the maximum depth with the doors open 1102 mm & the maximum width with 1383 mm.	Dimensions shown are the maximum depth with the doors open 1102 mm & the maximum width with 1383 mm.
There must be 25mm between the wall and the back of the appliance.			

Built-In Fridge Freezers

177CM TALL
70/30 SPLIT
FIXED HINGE
KI6873FE0G

Specifications

- Air outlet min. 200 cm²
- Ventilation space in the base min. 200 cm²

min. 40	B	B	Front panel overhang
	1151+B (max.)	1251+B (min.)	
	617+A (min.)	643+A (max.)	
	4	4	
	1A	1A	Lower edge of front panel

The specified unit door dimensions are valid for a door gap of 4 mm.

177CM TALL
70/30 SPLIT
SLIDING HINGE
KI5871SE0G

Specifications

- Air outlet min. 200 cm²
- Ventilation space in the base min. 200 cm²

min. 40	B	B	Front panel overhang
	919+B (max.)	841+B (min.)	
	849+A (min.)	927+A (max.)	
	4	4	
	1A	1A	Lower edge of front panel

The specified unit door dimensions are valid for a door gap of 4 mm.

177CM TALL
60/40 SPLIT
FIXED HINGE
KI7862FE0G,
KI7861FE0G

177CM TALL
60/40 SPLIT
SLIDING HINGE
KI7862SE0G,
KI7861SE0G

177CM TALL
70/30 SPLIT
FIXED HINGE
KI5872FE0G

Built-In Fridge Freezers

177CM TALL
70/30 SPLIT
SLIDING HINGE
 KI5872SE0G

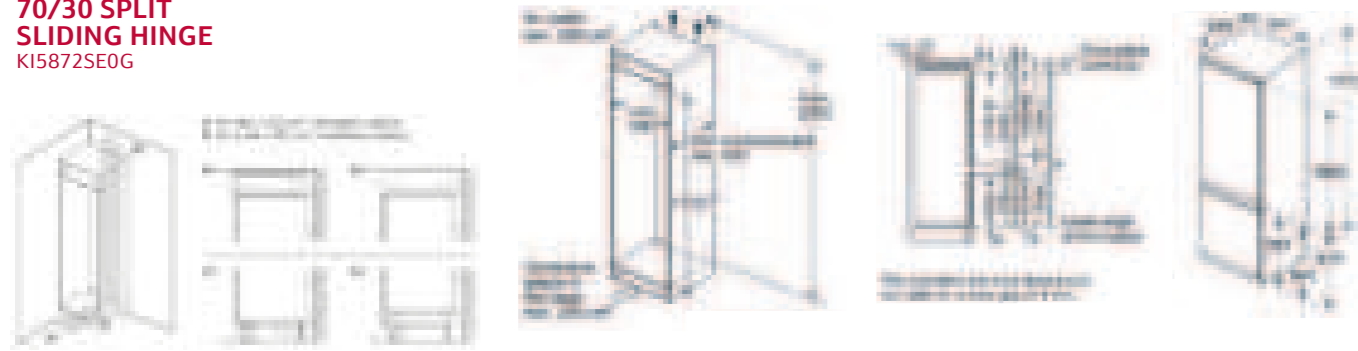

177CM TALL
60/40 SPLIT
SOFT CLOSE HINGE
 KI7863DD0G

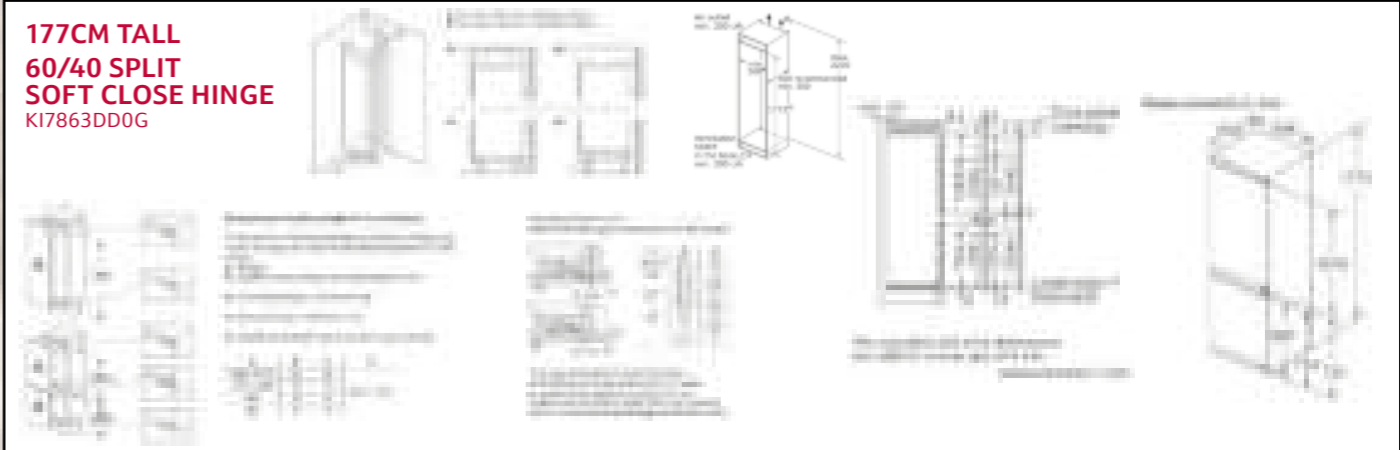

177CM TALL
60/40 SPLIT
SLIDING HINGE
 KI5862SE0G

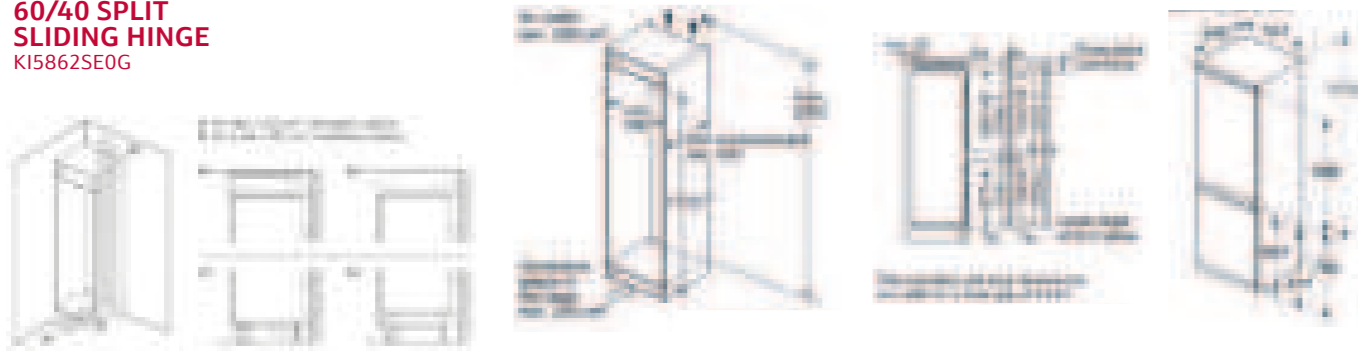

Built-In Single Door Fridges & Freezers

177CM TALL FRIDGES
FIXED HINGE
 KI1813FE0G, KI1812FE0G,
 KI2822FE0G – WITH 4* ICE BOX
DOOR OPEN ASSIST
SOFT CLOSE HINGE
 KI8815OD0G
SLIDING HINGE
 KI1811SE0G

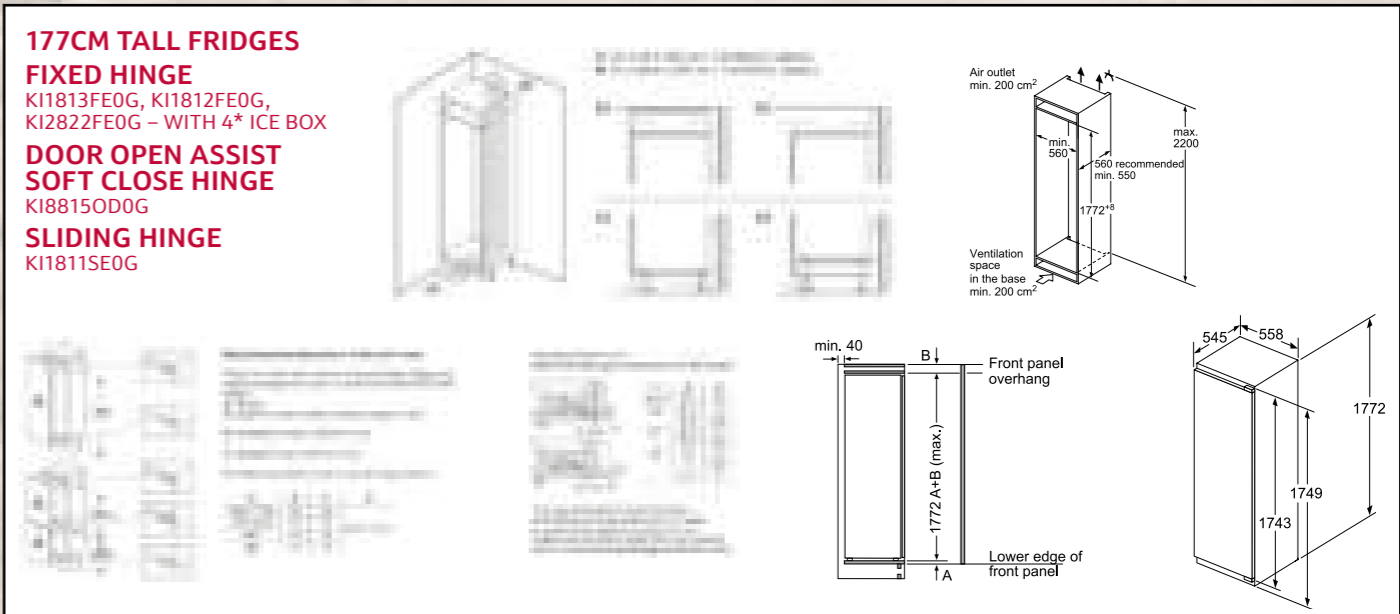

177CM TALL
50/50 SPLIT
FIXED HINGE
 KI7851FE0G

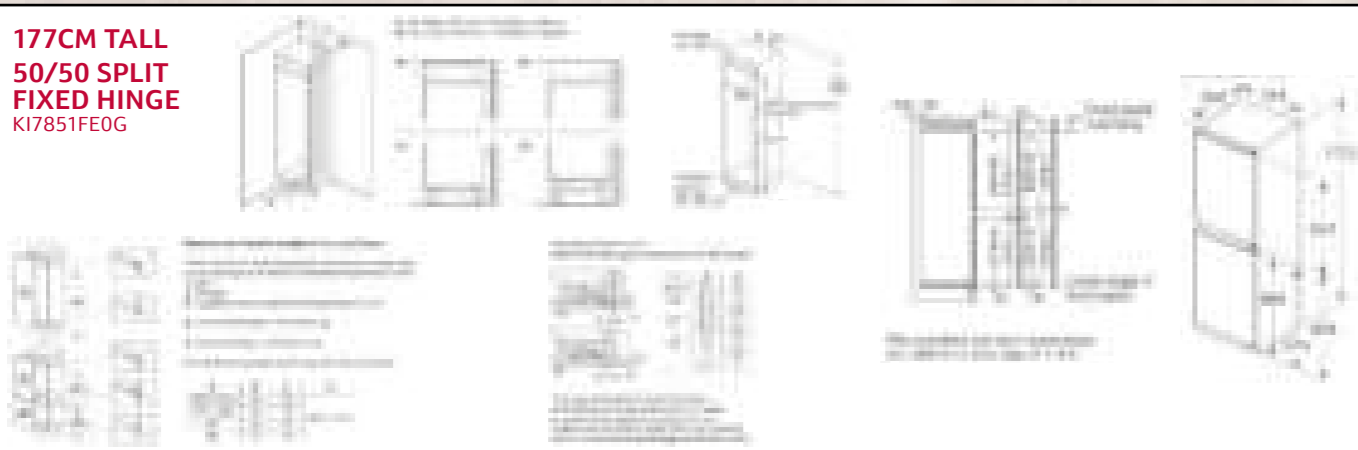

177CM TALL FREEZERS
FIXED HINGE
 GI7812EE0G
SOFT CLOSE HINGE
 GI7815CE0G
DOOR OPEN ASSIST
SOFT CLOSE HINGE
 GI7815NE0G

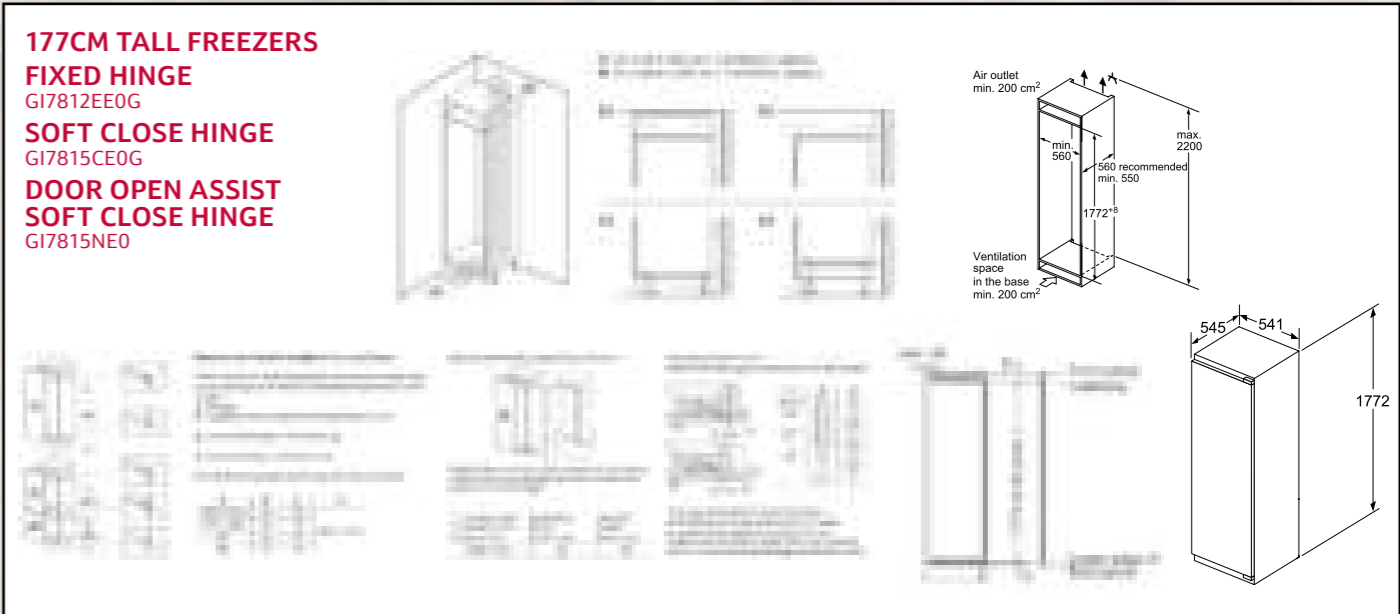

177CM TALL
50/50 SPLIT
SLIDING HINGE
 KI7851SE0G

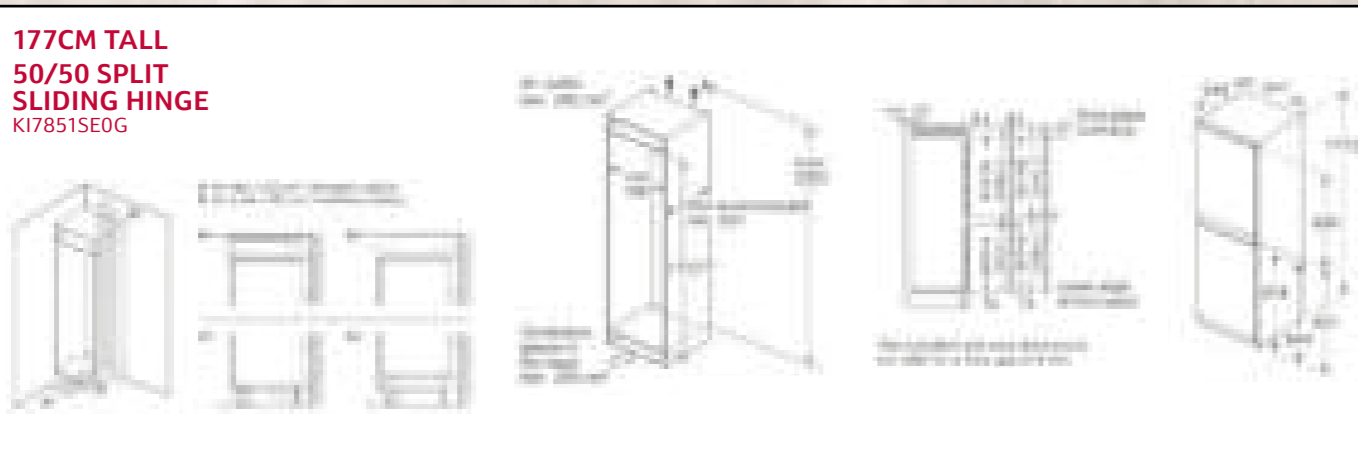

Built-In Single Door Fridges & Freezers

122CM TALL FRIDGES FIXED HINGE KI1412FE1G

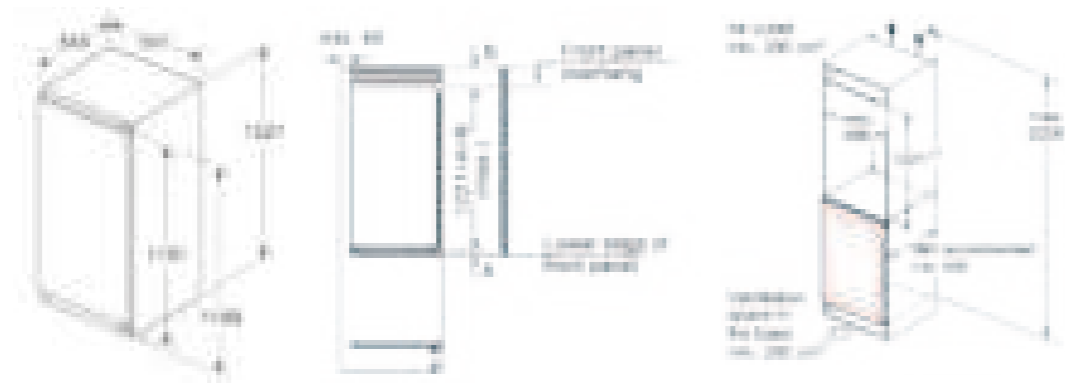

122CM TALL FRIDGE SLIDING HINGE KI1411SE0G

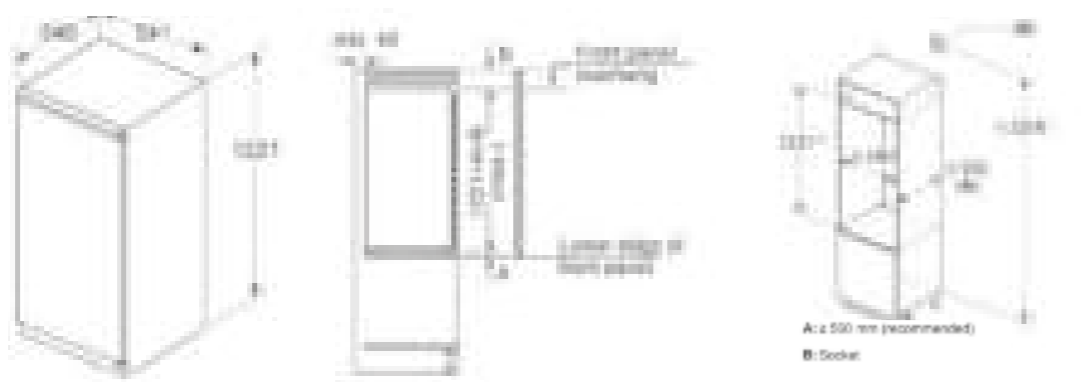

102CM TALL FRIDGE SLIDING HINGE KI1311SE0



88CM TALL FRIDGES FIXED HINGE KI1212FE0 SLIDING HINGE KI1211SE0

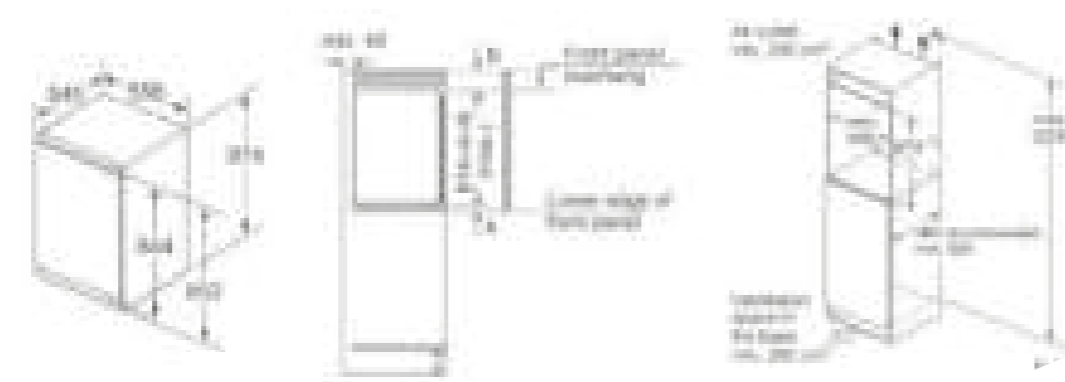

88CM TALL FREEZER SOFT CLOSE HINGE GI1216DE0

Built-In Single Door Fridges & Freezers

82CM TALL FRIDGES FIXED HINGE WITH ICE BOX KU2222FD0G FIXED HINGE KU1212FE0G

82CM TALL FREEZER FIXED HINGE GU7212FE0G

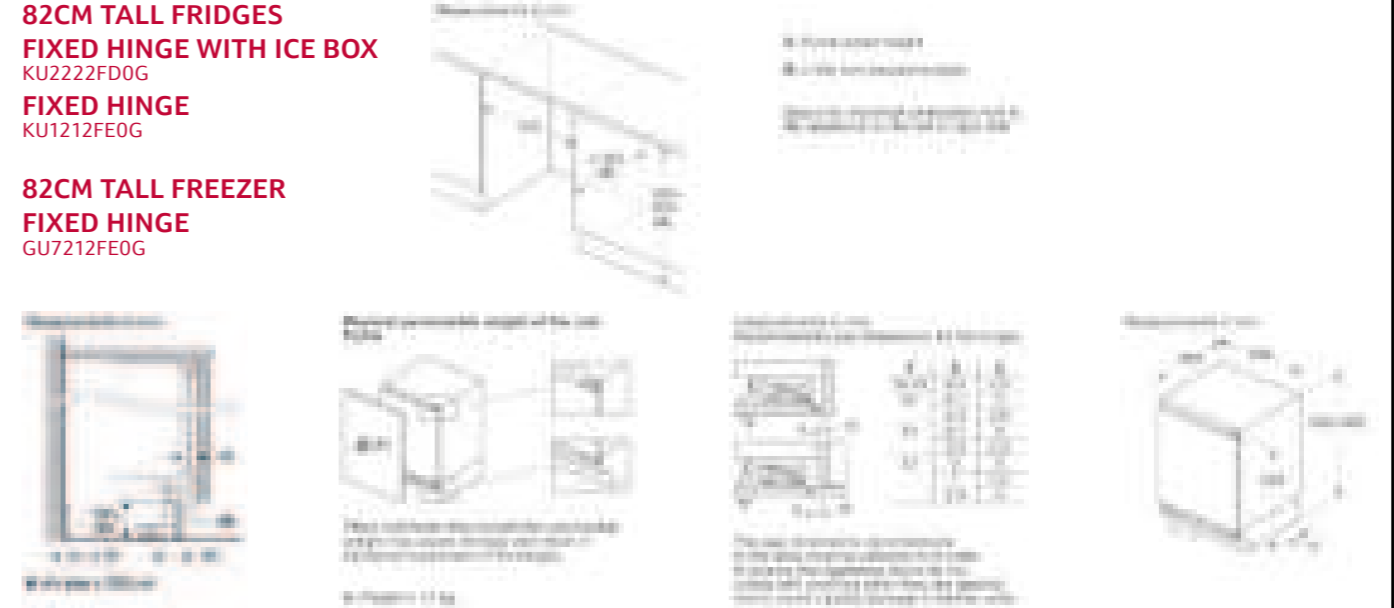

72CM TALL FREEZER FIXED HINGE GI1113FE0

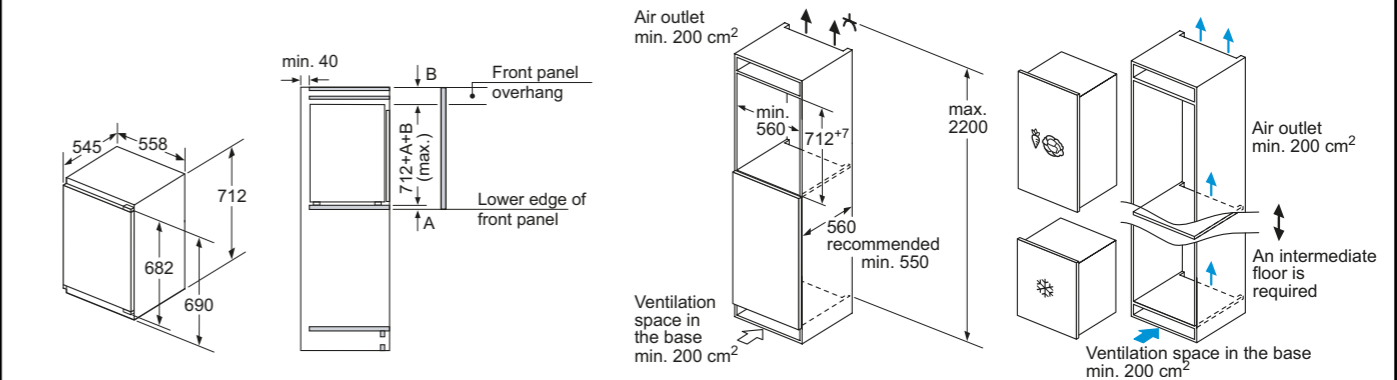

NEFF DISHWASHER *Range*

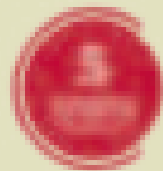

5 Year Warranty

Peace of mind built-in – all of NEFF's dishwashers are covered by our **5 year warranty** – clearly marked in the matrix tables. Further warranty information can be found on NEFF Customer Service pages 262-263.

Dishwasher Solutions



Clean dishes, whatever your wishes.

- Range includes fully integrated and slimline.
- The Vario Hinge gives maximum flexibility in fitted kitchens by allowing the door to slide over the plinth. A further benefit is it enables higher cabinet installation to improve reach and usability for people with reduced mobility or other accessibility needs.
- Comprehensive range of cleaning features including Chef 70°C and Eco 50°C as standard.

Full Size Dishwashers

Designed to be as flexible and accommodating as possible, our full-sized dishwashers have adjustable baskets and racks to hold large or awkward items, as well as a choice of wash cycles, from intensive to delicate.



Featured model:
S197YCX05G
N70 60cm Fully
Integrated
Dishwasher

Slimline Dishwashers

Where space is an issue, our Slimline model **S875HKX32G** is ideal. Just 45cm wide, it fits into the smallest of spaces, but still offers all the features of a full size model. It's surprisingly roomy and able to cope with nine place settings at a time.



Featured model:
S875HKX32G N50
45cm Fully Integrated
Dishwasher

NEFF Dishwashers Range at a glance

- All dishwasher models can be controlled by the NEFF Home Connect app
- Water consumption: 9.5L (60cm width) / 8.5L (45cm width)
- 10 year anti-rust warranty
- Noise level 40-46dB



Home Connect



All dishwashers come with a **5 Year Warranty**

VALUE CLASS	SIZE	VARIO HINGE		
		86.5CM	81.5CM	
N 90	TFT DISPLAY WITH BACKLIT BUTTONS 60CM FULLY INTEGRATED	S299ZB803E • Flex 3 baskets • Zeolith Technology • Intelligent programme • Gap Illumination • Door open assist • 13 place settings A B	S199ZB803E • Flex 3 baskets • Zeolith Technology • Intelligent programme • Gap Illumination • Door open assist • 13 place settings A B	
N 70	WHITE INDICATOR LIGHTS 60CM FULLY INTEGRATED		S197YCX05G • Flex 3 baskets • Zeolith Technology • Intelligent programme • Door open assist • Gap Illumination • Open Dry • 14 place settings A A	S197ZCX08G • Flex 2 baskets • Zeolith Technology • Intelligent programme • Door open assist • Gap Illumination • Quiet - 40dB • Time Light • 14 place settings A B
N 50	PUSH BUTTONS 60CM FULLY INTEGRATED	S295HCX17G • Flex 2 baskets • Gap Illumination • Door open assist • Flex Cutlery Drawer • 14 place settings A C	S195HCX17G • Flex 2 baskets • Gap Illumination • Door open assist • Flex Cutlery Drawer • 14 place settings A C	S175HVX14G • Flex 1 baskets • Rack Matic 3-stage • Flex Cutlery Drawer • Backlit button control • Info Light • 14 place settings A C
N50	PUSH BUTTONS 45CM FULLY INTEGRATED		S875HKX32G • Flex 1 baskets • Rack Matic 3-stage • Info Light • 10 place settings A D	
N 30	BLACK GLOSS 60CM FULLY INTEGRATED			

VARIO HINGE	FIXED HINGE		
	81.5CM	81.5CM	
S175HTX14G • Flex 1 baskets • Info Light • 13 place settings A C			
	S153HKX06G • Flex 1 baskets • Height adjustable top basket • Toggle control • Info Light • 13 place settings A C	S153HTX02G • Normal baskets • Toggle control • Info Light • 13 place settings A D	S153ITX07G • Normal baskets • Toggle control • Info Light • 13 place settings A D

DISCONTINUING MARCH 2027

NEW OCTOBER 2026

Fascia types

N 90 - TFT Display with Backlit Buttons

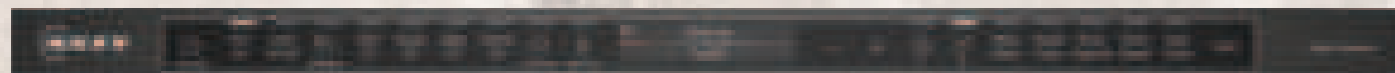

N 70 - White Indicator Lights

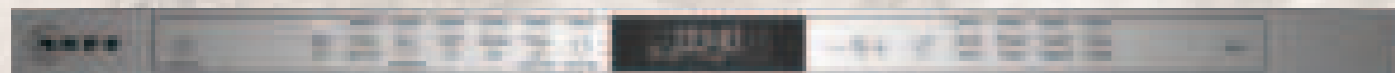

N50 - Push Buttons

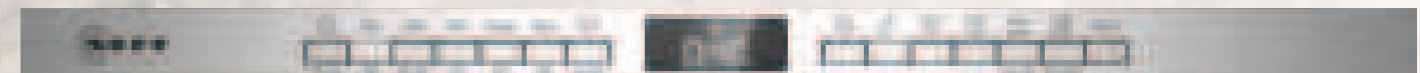

N 30 - Black Gloss

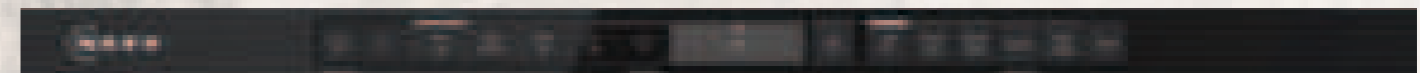

THE NEFF OVEN COLLECTIONS

HOBS

VENTILATION

REFRIGERATION

DISHWASHING

LAUNDRY

Key Functions Guide

Design Features



AQUA STOP

Protects inlet and outlet hoses from leakage. A safety valve prevents any more water from entering the dishwasher and overflowing – even when the machine is off.



OPEN DRY

No need to manually open the door of your dishwasher to allow the load to cool off. Open Dry takes care of that by opening the door automatically during the drying phase.



INFO LIGHT

Info Light projects a red light onto the floor that showcases clearly that this dishwasher is in operation. Info Light is available for fully integrated dishwashers.



HEAT EXCHANGER

Ensures that the drying phase of programmes is energy efficient and glassware is fully protected by preventing extreme temperatures.



DOOR OPEN ASSIST

Door Open Assist is the perfect solution for anybody looking to achieve a sleek, handleless design in their kitchen. Simply press lightly on the front of the unit to open the dishwasher door. Ideal for a range of integrated designs, Door Open Assist is also a convenient addition to busy kitchens. Electronic child lock can be activated, creating a double push to open.



ZEOLITH

The Zeolith compartment, located under the dishwasher cavity, contains natural minerals. During the drying phase, these minerals absorb moisture and release hot air. This ensures efficient drying and leaves an impressive sheen on items of all shapes and sizes, including difficult-to-dry plastic goods. And because they recharge during the next washing cycle, you get great, longlasting drying results, without the maintenance worries.



GAP ILLUMINATION

Gap Illumination shines a soft white light on the side of the dishwasher to indicate the dishwasher is running. If you pause the cycle or open the door, the light will start blinking. This feature is available across Vario Hinge models.



TIME LIGHT

Time Light projects the remaining time as well as the ongoing process of the programme on any type of kitchen floor. Time Light is available for fully integrated dishwashers and washing machines.



VARIO HINGE

Vario Hinge lets you install your dishwasher at floor level or higher. When you open the door, it lifts up the front panel so that it opens freely and doesn't make contact with the base underneath. Now you don't have to compromise on kitchen design, and your dishwasher will combine effortlessly with every other unit.



EMOTION LIGHT

LED lights in the front edge light up the dishwasher cavity.



GLASS CARE SYSTEM

Your dishwasher has a thing for delicate glassware, so it fine-tunes the water hardness to protect your glassware with never-ending care. A combination of the Glass 40° programme and Extra Shine option will clean your items impeccably without worry. With the introduction of anti-slip surfaces, silicon inserts and supports within Flex 2 baskets your glassware has never been more protected.

Special Functions



EXTRA SPEED

Depending on the selected programme, you can reduce the running time of your dishwasher's programme to up to 66%. Make more of your quality time and enjoy optimum cleaning and drying results - while Extra Speed takes care of the load up to three times faster.



POWER ZONE

Activates higher wash temperatures and increases the spray arm pressure in the bottom basket, while maintaining a more gentle wash in the top basket.



EXTRA SHINE

By increasing the amount of water during the rinse cycle and extending the drying phase, water marks are prevented and the drying result is further improved.

EXTRA HYGIENE

Provides a hotter final rinse, with 70°C water for 10 minutes, to effectively cleanse items such as chopping boards and cooking utensils*.

*Please note this programme does not sterilise.

Programmes



FAVOURITE

Choose a programme, option, or combination on your dishwasher and save it as "Favourite", either via the NEFF Home Connect app or directly on the dishwasher. As standard the Favourite button is a 15 min rinse.



1 HOUR 65°

No need to stack your dinner or party dishes for hours, simply load the dishwasher again. This function cleans and dries dishes in only 60 minutes. Spend more quality time with family and friends while enjoying food and tales using your favourite tableware.



EASY CLEAN

Give your dishwasher a deep clean with the new Easy Clean programme. Simply run the high temperature setting, together with some dishwasher cleaner, in an empty machine to remove limescale and grease from inside the cavity.



AUTOMATIC PROGRAMMES

Take the worry out of selecting exactly the right programme and let the machine do it for you. The programme automatically changes settings to ensure you get the best clean for your load.



SILENCE

Select 'Silence on demand' on the NEFF Home Connect app whenever you wish for peace and calm. On activation, the cycle will pause for 30 minutes. You have the flexibility to restart the cycle at anytime if you wish; after 30 minutes the programme will resume.



CHEF 70°C

With a hotter setting and a powerful spray, the Chef 70° programme is perfect for cleaning even the dirtiest pots, pans and cooking utensils. Items placed in the lower basket are subject to higher spray pressures, eliminating the need for soaking and effectively removing even the most stubborn stains.

10-YEAR, ANTI-RUST WARRANTY

Due to advanced materials and manufacturing technologies, in addition to our standard appliance warranty, we're able to provide a free-of-charge warranty against the rusting-through of the dishwasher's inner cavity.

Dishwasher Flexibility

Flex Baskets

Fitting casserole dishes, large pans, full dinner sets and tall-stem wine glasses into a dishwasher can be a challenge – especially when you're cleaning your most robust cookware alongside delicate items. Our Flex Baskets are designed to accommodate those bulkier items and provide an even, thorough clean. We have two options of basket flexibility to choose from.



Flex 1

Two foldable flip tines in the top basket and two foldable flip tines in the bottom basket offer quick and easy loading flexibility for safe positioning of glasses, cups, pots and pans.



Flex 2

Two foldable flip tines in the top basket and four foldable flip tines in the bottom basket offer quick and easy loading flexibility for safe positioning of glasses, cups, pots and pans.

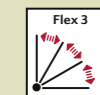

Flex 3

Six foldable flip tines in the top basket and eight foldable flip tines in the bottom basket offer quick and easy loading flexibility for safe positioning of glasses, cups, pots and pans.



Flex Cutlery Drawer

Transform your third loading level into a versatile cutlery drawer. It handily clicks into place whenever you need a tailor-made space for your forks, knives, and small kitchen utensils.





Rack-Matic

Allows the top basket to be raised and lowered as needed as well as run on an angle to cater for the wine glasses at the end of the night.

60cm Fully Integrated Dishwashers

ZEOLITH / VARIO HINGE

	S299ZB803E N90	S199ZB803E N90
	<ul style="list-style-type: none"> Flex 3 baskets Zeolith Technology Intelligent programme Gap Illumination TFT display 	<ul style="list-style-type: none"> Flex 3 baskets Vario Hinge - 81.5cm height Zeolith Technology Intelligent programme Gap Illumination TFT display Emotion Light 
Control panel colour	Black	Black
Height (cm) / Hinge type	86.5 / Vario Hinge	81.5 / Vario Hinge
DESIGN FEATURES		
Drying system	Zeolith / Open Dry	Zeolith / Open Dry
NEFF Home Connect	•	•
Control panel type	Touch control + TFT	Touch control + TFT
Basket description	Flex 3	Flex 3
Flex Cutlery Drawer (3rd loading level)	Flex Cutlery Drawer (Retrofit)	Flex Cutlery Drawer (Retrofit)
Status indicator	Gap Illumination (White)	Gap Illumination (White)
Door open assist	•	•
Glass care technology	•	•
Anti-slip protection / stemware support upper basket	• / •	• / •
Adjustable upper basket ⁶	Rack Matic 3-stage	Rack Matic 3-stage
Number of flip tines in upper / lower basket	6 / 8	6 / 8
Cup shelves upper / lower baskets	2 / 2	2 / 2
Cutlery holder lower basket	•	•
Largest loadable dish upper ⁷ / lower basket (cm)	29 / 33	27 / 30
Aqua sensor	•	•
Real-time clock	•	•
Start delay time max hours	24	24
Emotion light (interior lighting)	•	•
End of cycle indicator	Acoustic	Acoustic
Salt / Rinse aid light indicator	• / •	• / •
Self cleaning filter system	•	•
Flood protection system	Aqua Stop	Aqua Stop
Safety features	Door lock	Door lock
PROGRAMMES / FUNCTIONS		
List of programmes	Intelligent 40 °C, Eco 50 °C, Auto 45-65 °C, Chef 70 °C, Classic 60 °C, Glass 40 °C, Silence 50 °C, Favourite, Easy Clean	Intelligent 40 °C, Eco 50 °C, Auto 45-65 °C, Chef 70 °C, Classic 60 °C, Glass 40 °C, Silence 50 °C, Favourite, Easy Clean
Additional special options	Remote Start, Extra Shine, Power Zone, Extra Hygiene, Extra Speed	Remote Start, Extra Shine, Power Zone, Extra Hygiene, Extra Speed
TECHNICAL SPECIFICATIONS		
Reference programme for measurements	Eco 50 °C	Eco 50 °C
Energy efficiency class ¹	B	B
Energy ² / water ³ : kWh / litres	64 / 9	64 / 9
Load capacity (place settings)	13	13
Programme duration ⁴ : h:min	3:35	3:35
Noise level: dB (A) re 1 pW	40	40
Noise efficiency class	B	B
Noise level (silence programme): dB (A) re 1 pW	39	39
Length of electrical supply cord (cm)	175	175
Length inlet / outlet hose (cm)	165 / 190	165 / 190
Maximum height for installation (mm)	925	875
Maximum height adjustability feet (mm)	60	60
Maximum width for installation (mm)	600	600
Height of the product (mm)	865	815
Width / Depth of the product (mm)	598 / 550	598 / 550
Net weight / Gross weight (kg)	49 / 51	47 / 49
Water softener ⁵	•	•
Maximum accepted water hardness (°DH)	50	50
Maximum temperature for water intake (°C)	60	60
Interior cavity	Stainless steel	Stainless steel
Included accessories	Steam protection strip, Decorative strips (stainless steel)	Steam protection strip, Decorative strips (stainless steel)

ZEOLITH / VARIO HINGE

	S197YCX05G N70	S197ZCX08G N70	S295HCX17G N50
	<ul style="list-style-type: none"> Flex 3 baskets Zeolith Technology Vario Hinge - 81.5cm Open Dry Gap Illumination Door open assist 	<ul style="list-style-type: none"> Flex 2 baskets Zeolith Technology Vario Hinge - 81.5cm Intelligent programme Gap Illumination Door open assist 	<ul style="list-style-type: none"> Flex 2 baskets Vario Hinge - 86.5cm height Gap Illumination Door open assist Flex Cutlery Drawer 
Control panel colour	Stainless steel	Stainless steel	Stainless steel
Height (cm) / Hinge type	81.5 / Vario Hinge	81.5 / Vario Hinge	86.5 / Vario Hinge
DESIGN FEATURES			
Drying system	Zeolith / Open Dry	Zeolith	Heat exchanger
NEFF Home Connect	•	•	•
Control panel type	Touch control + LED	Touch control + LED	Push buttons + LED
Basket description	Flex 3	Flex 2	Flex 2
Flex Cutlery Drawer	Flex Cutlery Drawer	Flex Cutlery Drawer	Flex Cutlery Drawer
Status indicator	Gap Illumination (White)	Gap Illumination (White)	Gap Illumination (White)
Door open assist	•	•	•
Glass care technology	•	•	•
Anti-slip protection / stemware support upper basket	• / •	• / •	• / •
Adjustable upper basket ⁶	Rack Matic 3-stage	Rack Matic 3-stage	Rack Matic 3-stage
Number of flip tines in upper / lower basket	6 / 8	6 / 6	6 / 6
Cup shelves upper / lower baskets	2 / 2	2 / 2	2 / 2
Cutlery holder lower basket	•	•	•
Largest loadable dish upper ⁷ / lower basket (cm)	21 / 30	21 / 30	23 / 33
Aqua sensor	•	•	•
Real-time clock	•	•	•
Start delay time max hours	24	24	24
Emotion light (interior lighting)	•	•	•
End of cycle indicator	Acoustic	Acoustic	Acoustic
Salt / Rinse aid light indicator	• / •	• / •	• / •
Self cleaning filter system	•	•	•
Flood protection system	Aqua Stop	Aqua Stop	Aqua Stop
Safety features	Door lock	Door lock	Door lock
PROGRAMMES / FUNCTIONS			
List of programmes	Intelligent 40 °C, Eco 50 °C, Auto 45-65 °C, Chef 70 °C, Classic 60 °C, Express 45 °C, Glass 40 °C, Favourite, Easy Clean	Intelligent 40 °C, Eco 50 °C, Auto 45-65 °C, Chef 70 °C, Classic 60 °C, Glass 40 °C, Favourite, Easy Clean	Eco 50 °C, Auto 45-65 °C, Chef 70 °C, Classic 60 °C, Glass 40 °C, Favourite, Easy Clean
Additional special options	Remote Start, Extra Shine, Power Zone, Extra Speed	Remote Start, Extra Shine, Power Zone, Extra Speed	Remote Start, Extra Dry, Power Zone, Extra Speed
TECHNICAL SPECIFICATIONS			
Reference programme for measurements	Eco 50 °C	Eco 50 °C	Eco 50 °C
Energy efficiency class ¹	A	B	D
Energy ² / water ³ : kWh / litres	54 / 9.5	65 / 9	85 / 9
Load capacity (place settings)	14	14	14
Programme duration ⁴ : h:min	4:55	3:35	4:30
Noise level: dB (A) re 1 pW	44	40	42
Noise efficiency class	B	B	B
Noise level (silence programme): dB (A) re 1 pW	43	39	41
Length of electrical supply cord (cm)	175	175	175
Length inlet / outlet hose (cm)	165 / 190	165 / 190	165 / 190
Maximum height for installation (mm)	875	875	925
Maximum height adjustability feet (mm)	60	60	60
Maximum width for installation (mm)	600	600	600
Height of the product (mm)	815	815	865
Width / Depth of the product (mm)	598 / 550	598 / 550	598 / 550
Net weight / Gross weight (kg)	39.6 / 44	38 / 40	39 / 41
Water softener ⁵	•	•	•
Maximum accepted water hardness (°DH)	50	50	50
Maximum temperature for water intake (°C)	60	60	60
Interior cavity	Stainless steel	Stainless steel	Stainless steel
Included accessories	Steam protection strip	Steam protection strip	Steam protection strip

All of our dishwashers have Aqua Stop water protection, detergent aware, Dosage Assist and a door lock as standard. All NEFF dishwashers are suitable for use with doors from 2.5kg-8.5kg apart from SlimLine S875HKX20G (2.5kg to 7.5kg) and VarioHinge models S195HCX26G and S295HCX26G (4.5kg to 11.0kg) if the correct door springs are installed.

• = Yes, model has this feature

¹ On an energy-efficiency class scale from A to G.

² Energy consumption in kWh/100 operating cycles (using Eco programme).

³ Water consumption in litres/operating cycle (using Eco programme).

⁴ Duration of Eco programme.

⁵ We would recommend our dishwashers are connected to the mains water supply where possible. However, they may also be connected to an external water softener as long as the

water softener produces softened water of less than 1.1 mmol/litre (7.0°e) and the water softener in the appliance is turned off. Please contact product advice for further information. Water pressure required: 0.5-10 Bar. Flow rate: 10 litres per minute. Inlet valve connected directly to 3/8" screwed joint.

⁶ Adjustable upper basket is 2-stage Rackmatic™ when Flex 3rd Basket is installed.

⁷ Largest loadable dish height in upper basket will be smaller when Flex 3rd Basket is installed.

60cm Fully Integrated Dishwashers

	VARIO HINGE		RACK MATIC
	S195HCX17G N50	S175HTX14G N50	S175HVX14G N50
	<ul style="list-style-type: none"> Flex 2 baskets Vario Hinge – 81.5cm height Gap Illumination Door open assist Flex Cutlery Drawer 	<ul style="list-style-type: none"> Flex 1 baskets Vario Hinge – 81.5cm height Info Light 	<ul style="list-style-type: none"> Flex 1 baskets Vario Hinge – 81.5cm height Rack Matic 3-stage Info Light Flex Cutlery Drawer
Control panel colour	Stainless steel	Stainless steel	Stainless steel / Polinox
Height (cm) / Hinge type	81.5 / Vario Hinge	81.5 / Vario Hinge	81.5 / Fixed
DESIGN FEATURES			
Drying system	Heat exchanger	Heat exchanger	Heat exchanger
NEFF Home Connect	●	●	●
Control panel type	Push buttons + LED	Push buttons + LED	Push buttons + LED
Basket description	Flex 2	Flex 1	Flex 1
Flex Cutlery Drawer (3rd loading level)	Flex Cutlery Drawer		Flex Cutlery Drawer
Status indicator	Gap Illumination (White)	Info Light (Red)	Info Light (Red)
Door open assist	●		
Glass care technology	●	●	●
Anti-slip protection / stemware support upper basket	● / ●		
Adjustable upper basket ⁶	Rack Matic 3-stage	Height adjustable top basket	Rack Matic 3-stage
Number of flip tines in upper / lower basket	6 / 6	- / 2	2 / 4
Cup shelves upper / lower baskets	2 / 2	2 / -	2 / -
Cutlery holder lower basket	●	●	●
Largest loadable dish upper ⁷ / lower basket (cm)	21 / 30	27 / 30	21 / 30
Aqua sensor	●	●	●
Real-time clock			
Start delay time max hours	24	24	24
Emotion light (interior lighting)			
End of cycle indicator	Acoustic	Acoustic	Acoustic
Salt / Rinse aid light indicator	● / ●	● / ●	● / ●
Self cleaning filter system	●	●	●
Flood protection system	Aqua Stop	Aqua Stop	Aqua Stop
Safety features	Door lock	Door lock	Door lock
PROGRAMMES / FUNCTIONS			
List of programmes	Eco 50 °C, Auto 45-65 °C, Chef 70 °C, Classic 60 °C, Glass 40 °C, Favourite, Easy Clean	Eco 50 °C, Auto 45-65 °C, Chef 70 °C, Classic 60 °C, Glass 40 °C, Favourite, Easy Clean	Eco 50 °C, Auto 45-65 °C, Chef 70 °C, Classic 60 °C, Glass 40 °C, Favourite, Easy Clean
Additional special options	Remote Start, Extra Dry, Power Zone, Extra Speed	Remote Start, Extra Dry, Power Zone, Extra Speed	Remote Start, Extra Dry, Power Zone, Extra Speed
TECHNICAL SPECIFICATIONS			
Reference programme for measurements	Eco 50 °C	Eco 50 °C	Eco 50 °C
Energy efficiency class ¹	D	D	D
Energy ² / water ³ : kWh / litres	85 / 9	84 / 9	85 / 9
Load capacity (place settings)	14	13	14
Programme duration ⁴ : h:min	4:30	4:30	4:30
Noise level: dB (A) re 1 pW	42	46	46
Noise efficiency class	B	C	C
Noise level (silence programme): dB (A) re 1 pW	41	45	45
Length of electrical supply cord (cm)	175	175	175
Length inlet / outlet hose (cm)	165 / 190	165 / 190	165 / 190
Maximum height for installation (mm)	875	875	875
Maximum height adjustability feet (mm)	60	60	60
Maximum width for installation (mm)	600	600	600
Height of the product (mm)	815	815	815
Width / Depth of the product (mm)	598 / 550	598 / 550	598 / 550
Net weight / Gross weight (kg)	37 / 39	31 / 34	34 / 38
Water softener ⁵	●	●	●
Maximum accepted water hardness (°DH)	50	50	50
Maximum temperature for water intake (°C)	60	60	60
Interior cavity	Stainless steel	Stainless steel / Polinox	Stainless steel / Polinox
Included accessories	Steam protection strip	Steam protection strip	Steam protection strip

All of our dishwashers have Aqua Stop water protection, detergent aware, Dosage Assist and a door lock as standard. All NEFF dishwashers are suitable for use with doors from 2.5kg-8.5kg apart from SlimLine S875HKX20G (2.5kg to 7.5kg) and VarioHinge models S195HCX26G and S295HCX26G (4.5kg to 11.0kg) if the correct door springs are installed.

	INFO LIGHT		
	S153HKX06G N30	S153HTX02G N30 DISCONTINUING MARCH 2027	S153ITX07G N30 NEW OCTOBER 2026
	<ul style="list-style-type: none"> Flex 1 baskets Info Light 	<ul style="list-style-type: none"> Normal baskets Info Light 	<ul style="list-style-type: none"> Normal baskets Info Light
Control panel colour	Stainless steel	Stainless steel	Stainless steel
Height (cm) / Hinge type	81.5 / Fixed	81.5 / Fixed	81.5 / Fixed
DESIGN FEATURES			
Drying system	Heat exchanger	Heat exchanger	Heat exchanger
NEFF Home Connect	●	●	●
Control panel type	Toggle control + LED	Toggle control + LED	Toggle control + LED
Basket description	Flex 1	Normal	Normal
Flex Cutlery Drawer (3rd loading level)			
Status indicator	Info Light (Red)	Info Light (Red)	Info Light (Red)
Door open assist	●	●	●
Glass care technology	●	●	●
Anti-slip protection / stemware support upper basket	●	●	●
Adjustable upper basket ⁶	Height adjustable top basket		
Number of flip tines in upper / lower basket	- / 2	- / -	- / -
Cup shelves upper / lower baskets	2 / -	2 / -	2 / -
Cutlery holder lower basket	●	●	●
Largest loadable dish upper ⁷ / lower basket (cm)	27 / 30	22 / 30	22 / 30
Aqua sensor	●	●	●
Real-time clock			
Start delay time max hours	9	9	9
Emotion light (interior lighting)			
End of cycle indicator	Acoustic	Acoustic	Acoustic
Salt / Rinse aid light indicator	● / ●	● / ●	● / ●
Self cleaning filter system	●	●	●
Flood protection system	Aqua Stop	Aqua Stop	Aqua Stop
Safety features	Door lock	Door lock	Door lock
PROGRAMMES / FUNCTIONS			
List of programmes	Eco 50 °C, Auto 45-65 °C, Chef 70 °C, Classic 60 °C, Favourite, Easy Clean	Eco 50 °C, Auto 45-65 °C, Chef 70 °C, Classic 60 °C, Favourite, Easy Clean	Eco 50 °C, Auto 45-65 °C, Chef 70 °C, Classic 60 °C, Favourite, Easy Clean
Additional special options	Remote Start, Extra Dry, Power Zone, Extra Speed	Remote Start, Extra Dry, Power Zone, Extra Speed	Remote Start, Extra Dry, Power Zone, Extra Speed
TECHNICAL SPECIFICATIONS			
Reference programme for measurements	Eco 50 °C	Eco 50 °C	Eco 50 °C
Energy efficiency class ¹	C	D	D
Energy ² / water ³ : kWh / litres	73 / 9	84 / 9	84 / 9
Load capacity (place settings)	13	13	13
Programme duration ⁴ : h:min	4:55	4:30	4:30
Noise level: dB (A) re 1 pW	44	46	46
Noise efficiency class	B	C	C
Noise level (silence programme): dB (A) re 1 pW	43	45	45
Length of electrical supply cord (cm)	175	175	175
Length inlet / outlet hose (cm)	165 / 190	165 / 190	165 / 190
Maximum height for installation (mm)	875	875	875
Maximum height adjustability feet (mm)	60	60	60
Maximum width for installation (mm)	600	600	600
Height of the product (mm)	815	815	815
Width / Depth of the product (mm)	598 / 550	598 / 550	598 / 550
Net weight / Gross weight (kg)	32 / 34	30 / 32	30 / 32
Water softener ⁵	●	●	●
Maximum accepted water hardness (°DH)	35	50	50
Maximum temperature for water intake (°C)	60	60	60
Interior cavity	Stainless steel	Stainless steel / Polinox	Stainless steel / Polinox
Included accessories	Steam protection strip	Steam protection strip	Steam protection strip

● = Yes, model has this feature

¹ On an energy-efficiency class scale from A to G.

² Energy consumption in kWh/100 operating cycles (using Eco programme).

³ Water consumption in litres/operating cycle (using Eco programme).

⁴ Duration of Eco programme.

⁵ We would recommend our dishwashers are connected to the mains water supply where possible. However, they may also be connected to an external water softener as long as the

water softener produces softened water of less than 1.1 mmo/litre (7.0°e) and the water softener in the appliance is turned off. Please contact product advice for further information. Water pressure required: 0.5-10 Bar. Flow rate: 10 litres per minute. Inlet valve connected directly to ¾" screwed joint.

⁶ Adjustable upper basket is 2-stage Rackmatic™ when Flex 3rd Basket is installed.

⁷ Largest loadable dish height in upper basket will be smaller when Flex 3rd Basket is installed.

45cm Slimline Dishwasher

VARIO HINGE
S875HKX32G | N50

- Flex 2 baskets
- Vario Hinge – 81.5cm height
- Rack Matic 3-stage
- Info Light



Control panel colour	Stainless steel
Height (cm) / Hinge type	81.5 / Vario Hinge
DESIGN FEATURES	
Drying system	Heat exchanger
NEFF Home Connect	•
Control panel type	Push buttons + LED
Basket description	Flex 2
Flex Cutlery Drawer (3rd loading level)	
Status indicator	Info Light (Red)
Door open assist	
Glass care technology	•
Anti-slip protection / stemware support upper basket	• / -
Adjustable upper basket ⁶	Rack Matic 3-stage
Number of flip tines in upper / lower basket	2 / 2
Cup shelves upper / lower baskets	2 / 1
Cutlery holder lower basket	•
Largest loadable dish upper ⁷ / lower basket (cm)	27 / 30
Aqua sensor	•
Real-time clock	
Start delay time max hours	24
Emotion light (interior lighting)	
End of cycle indicator	Acoustic
Salt / Rinse aid light indicator	• / •
Self cleaning filter system	•
Flood protection system	Aqua Stop
Safety features	Door lock
PROGRAMMES / FUNCTIONS	
List of programmes	Eco 50 °C, Auto 45-65 °C, Chef 70 °C, Classic 60 °C, Glass 40 °C, Favourite, Easy Clean
Additional special options	Remote Start, Extra Dry, Power Zone, Extra Speed
TECHNICAL SPECIFICATIONS	
Reference programme for measurements	Eco 50 °C
Energy efficiency class ¹	D
Energy ² / water ³ : kWh / litres	67 / 8.9
Load capacity (place settings)	10
Programme duration ⁴ : h:min	4:35
Noise level: dB (A) re 1 pW	44
Noise efficiency class	B
Noise level (silence programme): dB (A) re 1 pW	43
Length of electrical supply cord (cm)	175
Length inlet / outlet hose (cm)	165 / 205
Maximum height for installation (mm)	875
Maximum height adjustability feet (mm)	60
Maximum width for installation (mm)	450
Height of the product (mm)	815
Width / Depth of the product (mm)	448 / 550
Net weight / Gross weight (kg)	28 / 30
Water softener ⁵	•
Maximum accepted water hardness (°DH)	50
Maximum temperature for water intake (°C)	60
Interior cavity	Stainless steel
Included accessories	Steam protection strip

• = Yes, model has this feature

¹ On an energy-efficiency class scale from A to G.
² Energy consumption in kWh/100 operating cycles (using Eco programme).
³ Water consumption in litres/operating cycle (using Eco programme).
⁴ Duration of Eco programme.
⁵ We would recommend our dishwashers are connected to the mains water supply where possible. However, they may also be connected to an external water softener as long as the water softener produces softened water of less than 1.1 mmol/litre (7.0°e) and the water softener in the appliance is turned off. Please contact product advice for further information. Water pressure required: 0.5-10 Bar. Flow rate: 10 litres per minute. Inlet valve connected directly to 3/4" screwed joint.
⁶ Adjustable upper basket is 2-stage Rackmatic™ when Flex 3rd Basket is installed.
⁷ Largest loadable dish height in upper basket will be smaller when Flex 3rd Basket is installed.

All of our dishwashers have Aqua Stop water protection, detergent aware, Dosage Assist and a door lock as standard. All NEFF dishwashers are suitable for use with doors from 2.5kg-8.5kg apart from SlimLine S875HKX20G (2.5kg to 7.5kg) and Vario Hinge models S195HCX26G and S295HCX26G (4.5kg to 11.0kg) if the correct door springs are installed.

60cm Flex Design and Fully Integrated Dishwashers

S295HCX17G, S195HCX17G, S175HVX14G, S175HTX14G, S153HKX06G, S199ZB803E, S299ZB803E

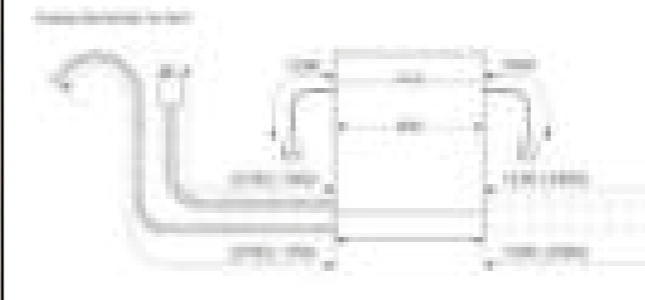

S195HCX17G, S175HVX14G, S175HTX14G, S153HKX06G, S153HTX02G, S153ITX07G

Aqua Stop

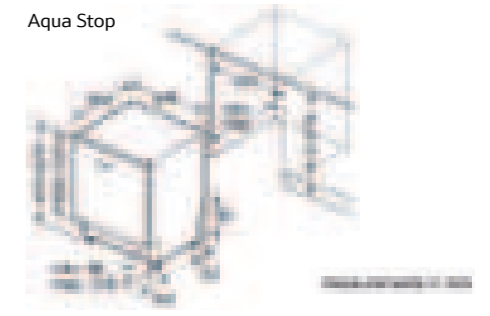

S295HCX17G



S197YCX05G

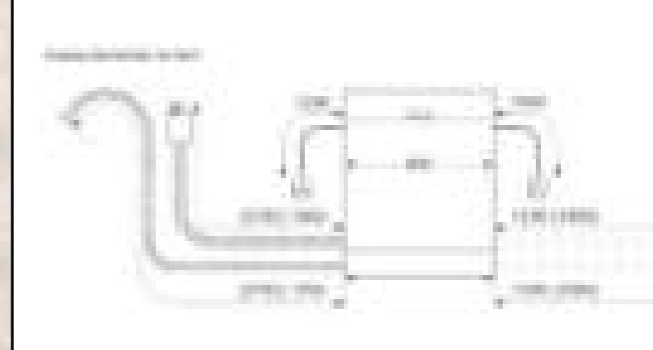

45cm Slimline Dishwasher

S875HKX32G

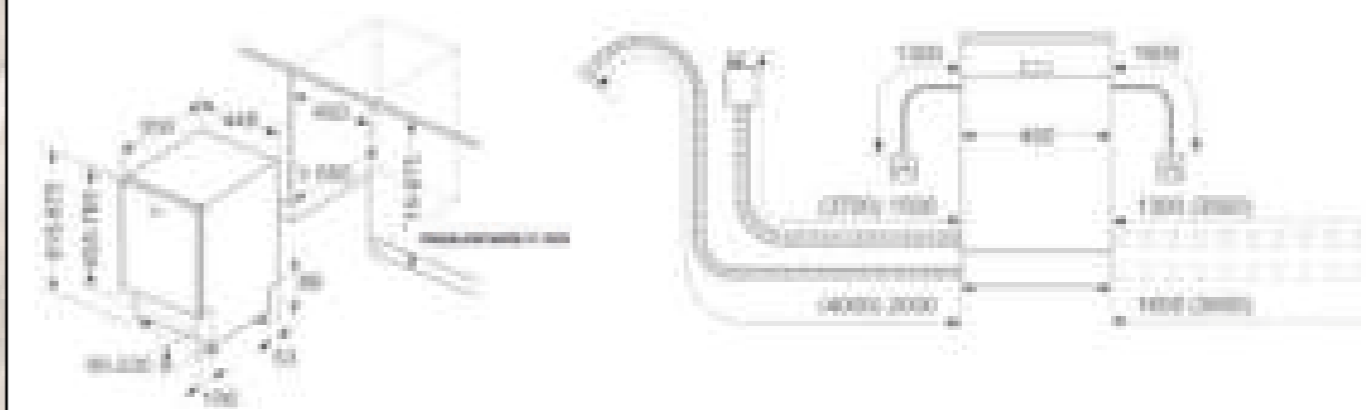

Dishwasher Accessories

Accessory	Model Number
Decor strip - For full size Polinox base models, 81.5cm height	Z780BI02
Decor strip - For full size and slimline Stainless Steel base models, 81.5cm height	Z780BI01
Decor strip - For full size Stainless Steel base models, 86.5cm height	Z780BI11
Decor strip - For full size Stainless Steel base models installed off the ground, 81.5cm height	Z7860X3
Decor strip - For full size Stainless Steel base models installed off the ground, 86.5cm height	Z7861X3
Split door furniture connection rail	Z788BI00
Cutlery Basket - 60cm Dishwashers	Z7863X0

Measurements in mm. The line drawings featured in this brochure are provided as a guide to general dimensions only and are subject to amendment without prior notice. For full dimensional and installation details please refer to the documentation supplied with the appliance.

THE NEFF OVEN COLLECTIONS

HOBS

VENTILATION

REFRIGERATION

DISHWASHING

LAUNDRY

NEFF LAUNDRY RANGE



- Comprehensive range of laundry solutions.
- 3 types of laundry appliances
 - Integrated Washing Machines
 - Integrated Washer Dryers
 - Freestanding Washer Dryer – ideal for a utility room
- All feature our signature innovations.
- Features that suit an open plan kitchen installation with laundry as part of it include;
 - Time Light to see when the cycle has ended.
 - Anti Vibration Side panels to minimise noise.
- All features detailed in the following section.

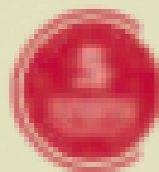

5 Year Warranty

Peace of mind built-in – many of NEFF's laundry appliances are covered by our **5 year warranty** – clearly marked in the matrix tables. Further warranty information can be found on NEFF Customer Service pages 262-263.

Key Functions Guide

Key Features

INTELLIGENT WATER SYSTEM

Efficient washing is made simple with our built-in load sensor. With up to 256 load levels distinguished and a flow sensor for detecting the kind of textile, the amount of water used is tailored to your wash.

SENSOR DRYING

Continuously monitors the drying performance using sophisticated sensors to prevent overheating and over drying. The dryer stops automatically when the correct level of dryness is reached to deliver the finest fabric care and reduce ironing.

ANTI-VIBRATION SIDE PANELS

Our side panels increase stability and reduce vibrations during even the fastest spin cycle. With a 3-step system which absorbs motor vibrations, centres unbalanced laundry and compensates for vibrations on the side walls, you benefit from low noise washing with every load.

Additional Features

TIME DELAY

Allows you to programme the machine up to 24 hours in advance to suit any schedule or to take advantage of off-peak electricity rates.

DRUM LIGHT

The drum interior LED light is a big help when unloading your fully-integrated NEFF built-in washing machine. It lights up the inside brightly enough so you'll never overlook another item of laundry.

Programmes

STAIN-REMOVAL PROGRAMME

Banish even the most stubborn stains with our stain-specific programmes. With dedicated settings for red wine spillages, tomato splashes and butter/oil residue, there's no need to worry about cooking-related stains.

Options

LESS IRONING

Reduces the creasing of clothes as the water is gently removed from the wash with a light interval spin at the end of the cycle.

EXTRA RINSE OPTION

Available on almost every programme, it's especially helpful for sensitive skin.

TIME LIGHT

The time remaining of the wash cycle is clearly projected on to any floor surface. So you don't have to open the door to see when your washing will be finished. Perfect for open plan kitchens. Featured on model W544BX2GB.

EASY INSTALLATION - CARDAN DRIVE

With our Cardan Drive system, installing your built-in washing machine is super easy. Our machines can easily be adapted to the height of your worktop. The Cardan system allows the rear feet to be adjusted from the front of the washer, for any niche up to 60mm. Slide the machine into your kitchen unit, then simply adjust the feet easily from the front with a screwdriver.

AQUA STOP / AQUA SECURE

Protects inlet hoses from leakage. A safety valve prevents any more water from entering the washing machine.

RELOAD FUNCTION

If you need to add or remove an item after the programme has started, you can pause the cycle by pressing the Start/Reload button. The machine will check whether you can open the door and, if so, it lets you. To resume operation, just press the Start/Reload button again.

DRUM CLEAN WITH REMINDER

Prevent odours and germs with our handy Drum Clean reminder. When the machine detects a consecutive number of low washing temperatures (<40°), you'll be prompted to start the Drum Clean programme.

SPEED PERFECT

Cuts programme times by up to 65%. Simply select the cycle you wish to run and then select Speed Perfect.

Some features are relevant for freestanding models only. For full details please refer to the website.

Integrated Laundry

WASHING MACHINES

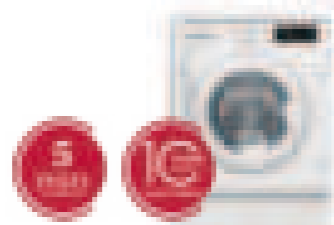
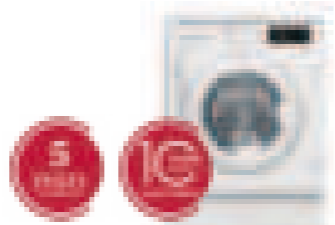
W544BX2GB	W543BX2GB
<ul style="list-style-type: none"> • Time Light • Speed Perfect • Reload function • Targeted Stain Removal • Variable Temperature • Cardan Drive - Easy Installation 	<ul style="list-style-type: none"> • Speed Perfect • Reload function • Cardan Drive - Easy Installation 

KEY FEATURES		
Time Light	•	
Speed Perfect	•	
Reload function	•	•
Targeted stain removal	•	
Reduced noise wash	•	
ADDITIONAL FEATURES		
Time delay	h	24
Control panel lock	•	•
Water protection system	Aqua Stop	Aqua Stop
PROGRAMMES / FUNCTIONS		
Cottons	•	•
Eco 40-60	•	•
Easy-care programme	•	•
Wool programme	•	•
Super Quick 15 / 30'	•	•
Mixed load	•	•
Shirts	•	•
Stain removal	Tomatoes, Red Wine, Butter/Oil	
Delicates / Silk	•	•
Rinse	•	•
Spin / Drain	•	•
Drum Clean	•	•
OPTIONS		
Pre-wash	•	•
Extra rinse	•	•
Variable temperature / Variable spin	•/•	/•
PERFORMANCE / TECHNICAL INFORMATION		
Energy efficiency class ¹		
Load capacity	kg	1-8
Energy ² / Water ³	kWh / litres	62 / 45
Programme duration ⁴	h:mm	3:16
Maximum spin speed ⁵	rpm	1400
Spin efficiency class		B
Noise level	dB(A) re 1 pW	66
Noise emission class		A
Dimensions of the product	mm	818 x 596 x 544 (574)
Door opening angle		130°
Depth with open door 90°	mm	956
Height adjustability	mm	120
Length of electrical supply cord	cm	210
Length of supply hose / drain hose	cm	150/150
Door hinge (porthole)		Left-hand
Easy installation Cardan Drive System	•	•

Not all options and programmes are shown, this is a guide, please refer to the website for more details. ¹On an energy-efficiency class scale from A to G. ²Energy consumption in kWh/100 operating cycles (using Eco 40-60 programme). ³Water consumption in litres/operating cycle (using Eco 40-60 programme). ⁴Duration of Eco 40-60 programme. ⁵The specified value is rounded.

Freestanding

WASHER DRYERS

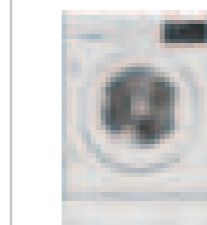
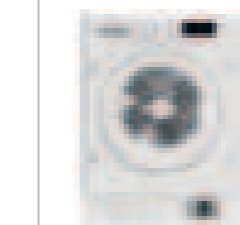
V8540X0GB	V8340X0GB
<ul style="list-style-type: none"> • Drum light • Iron Assist 	<ul style="list-style-type: none"> • Sensor drying • Rapid 15' / Wash & Dry 60' • Adjustable temperature & spin speed 

KEY FEATURES		
Electronic control dial	•	•
Time selection options	•	•
Sensor controlled drying	•	•
ADDITIONAL FEATURES		
Time delay	h	24
Control panel lock	•	•
Water protection system	Aqua Stop	Aqua Secure
STANDARD PROGRAMMES		
Cottons	•	•
Eco 40-60	•	•
Easy-care programme	•	•
Wool programme	•	•
Delicates / Silk	•	•
Intensive dry	•	•
Gentle dry	•	•
ADDITIONAL PROGRAMMES		
Super Quick 15'	•	•
Reduced noise wash	•	•
Sportswear	•	•
Mixed load	•	•
Fluff removal programme	•	•
Iron Assist	•	•
OPTIONS		
Flexi Time	•	•
Intensive	•	•
Pre-wash	•	•
Extra rinse	•	•
Less ironing	•	•
Variable temperature	•	•
Variable spin speed	•	•
PERFORMANCE / TECHNICAL INFORMATION		
Energy efficiency class washing and drying ¹		
Energy efficiency class washing ²		
Energy ³ / Water ⁴ washing and drying	kWh / litres	324 / 80
Energy ⁵ / Water ⁶ washing	kWh / litres	47 / 48
Load capacity washing and drying / washing	kg	1-5 / 1-8
Programme duration ⁷ washing and drying / washing	h:mm	9:20 / 3:38
Spin efficiency class		B
Spin speed ⁸	rpm	1400
Noise level	dB(A) re 1 pW	68
Noise emission class		A
Dimensions of the product	mm	820 x 594 x 550 (574)
Door opening angle		95°
Depth with open door 90°	mm	975
Height adjustability	mm	160
Length of electrical supply cord	cm	200
Length of supply hose / drain hose	cm	150 / 120
Door hinge (porthole)		Left-hand

Not all options and programmes are shown, this is a guide, please refer to the website for more details.

^{1,2}On an energy-efficiency class scale from A to G. ³Energy consumption in kWh/100 complete operating cycles (using Eco 40-60 programme). ⁴Water consumption in litres/complete operating cycle (using Eco 40-60 programme). ⁵Energy consumption in kWh/100 wash cycles (using Eco 40-60 programme). ⁶Water consumption in litres/wash cycle (using Eco 40-60 programme). ⁷Duration of Eco 40-60 programme, complete operating cycle/wash cycle. ⁸The specified value is rounded.

WASHER DRYER

VNA341U8GB
<ul style="list-style-type: none"> • Auto Dry • Sensor drying • Rapid 15' / Wash & Dry 60' • Speed Perfect 

KEY FEATURES	
Auto Dry - Sensor Drying	•
Anti Vibration design	•
Anti Crease cycle	•
Reload facility	•
ADDITIONAL FEATURES	
Time delay	h
Control panel lock	•
Interior drum light	•
Water protection system	Aqua Secure
PROGRAMMES / FUNCTIONS	
Eco 40-60	•
Cottons	•
Refresh	•
Easy-care programme	•
Mixed load	•
Delicates / Silk	•
Wool programme	•
Red wine	•
Rapid 15' / Wash & Dry 60'	•
Intensive Dry	•
Gentle Dry	•
My time Dry	•
Prewash	•
Easy Iron	•
Speed Perfect	•
Variable temperature / Variable spin	•
PERFORMANCE / TECHNICAL INFORMATION	
Energy efficiency class washing and drying ¹	
Energy efficiency class washing ²	
Energy efficiency class drying	
Energy ³ / Water ⁴ washing and drying	kWh / litres
Energy ⁵ / Water ⁶ washing	kWh / litres
Load capacity washing and drying / washing	kg
Programme duration ⁷ washing and drying / washing	h:mm
Spin efficiency class	
Spin speed ⁸	rpm
Capacity cotton	kg
Ambient temperature range	°C
Noise level	dB(A) re 1 pW
Noise efficiency class	
Dimensions of the product	mm
h x w x d (inc. door porthole)	mm
Door opening angle	
Depth with door open 90°	mm
Door hinge (porthole)	

^{1,2}On an energy-efficiency class scale from A to G. ³Energy consumption in kWh/100 complete operating cycles (using Eco 40-60 programme).

⁴Water consumption in litres/complete operating cycle (using Eco 40-60 programme). ⁵Energy consumption in kWh/100 wash cycles (using Eco 40-60 programme). ⁶Water consumption in litres/wash cycle (using Eco 40-60 programme). ⁷Duration of Eco 40-60 programme, complete operating cycle/wash cycle. ⁸The specified value is rounded.

Fully Integrated Laundry

Built-in Washing Machines

W544BX2GB,
W543BX2GB

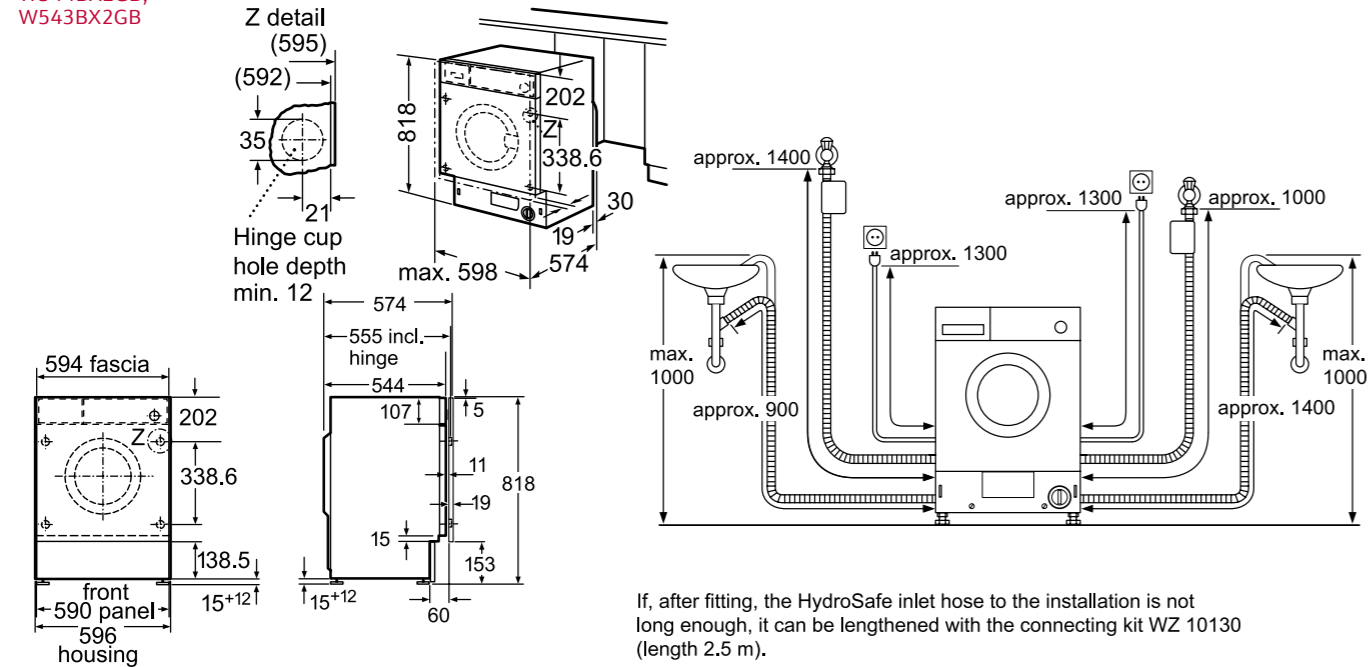

Built-in Washer Dryer

V6540X3GB

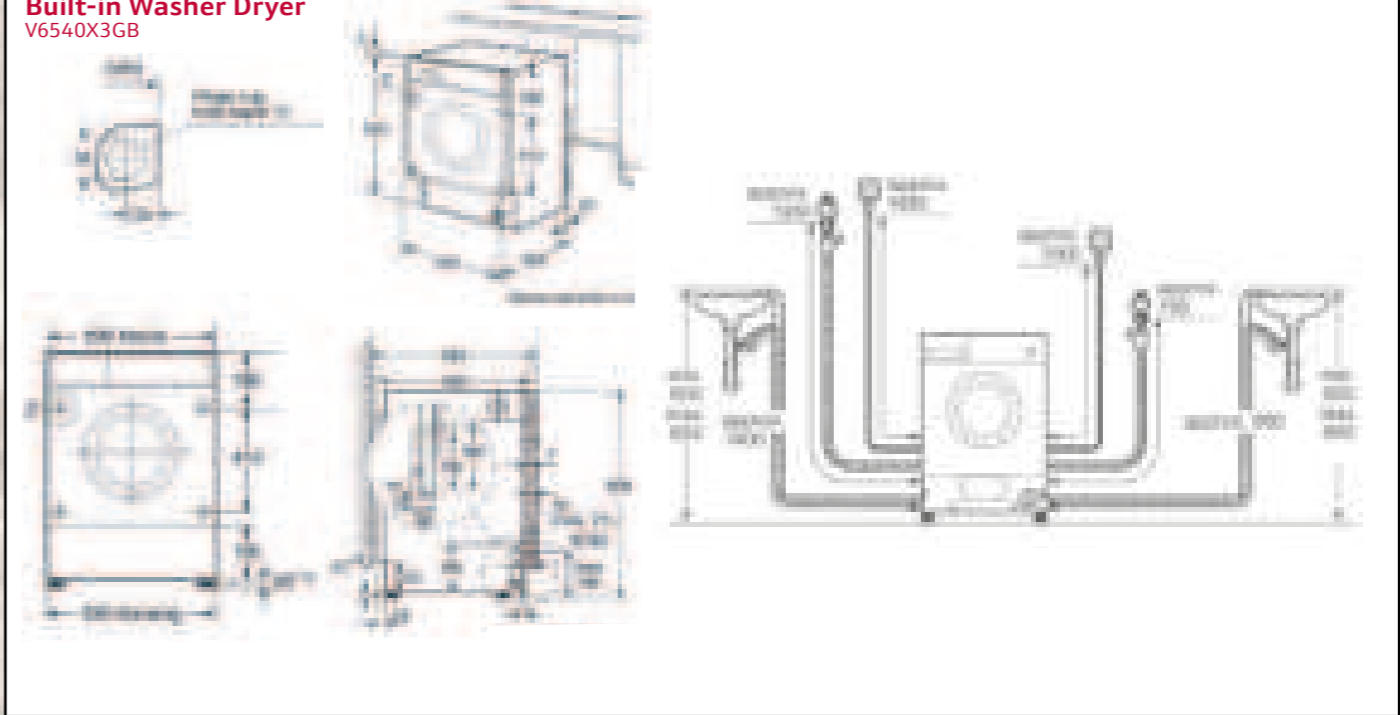

Built-in Washer Dryer

V6320X2GB

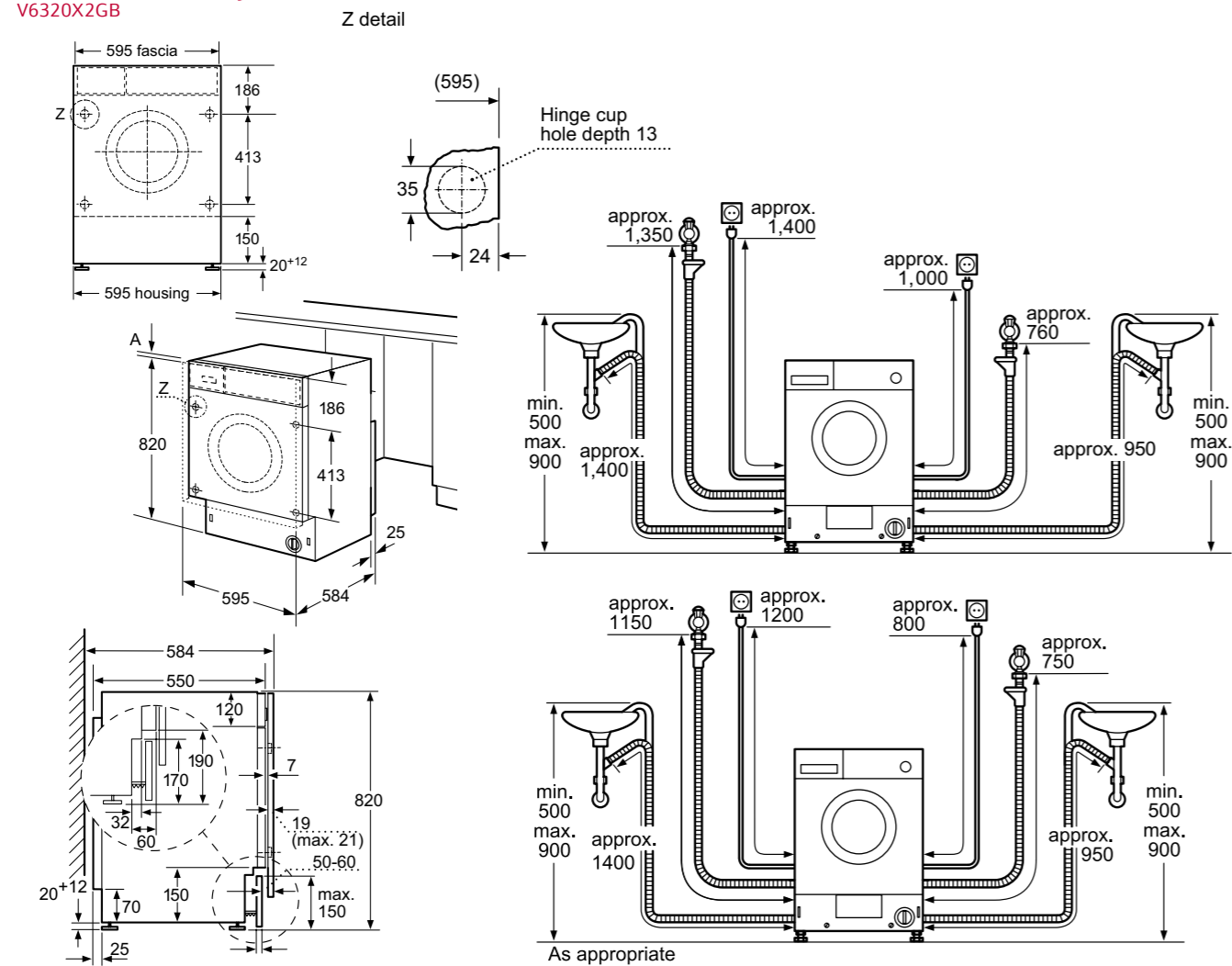

Freestanding Laundry

Freestanding Washer Dryer

VNA341U8GB



Committed to EXCELLENCE

Our commitment to excellence extends beyond our products. We provide outstanding customer service and support, ensuring that you feel supported every step of the way.

NEFF Customer Service

Here at NEFF, we understand that although our kitchens and appliances are designed to cope with even the most exacting cookaholics, sometimes you need to turn to us for help. Whether you need a visit from one of our engineers, some spare parts for your NEFF appliance or just some helpful advice, we're here to talk – around the clock*.

GIVE US A CALL ON
0344 892 8979
(01) 450 2655

VISIT OUR WEBSITE AT
 **NEFF-HOME.COM/UK**
 **NEFF-HOME.COM/IE**

*We're available 7 days a week. For our opening hours please check our website. Calls are charged at the basic rate, please check with your telephone service provider for exact charges. In some areas we may use an approved service partner and the process may vary for repairs carried out by our service partners.

NEFF is a division of BSH Home Appliances Limited, a company registered in England and Wales under company registration number 01844007, with registered office at: Grand Union House, Old Wolverton Road, Wolverton, Milton Keynes, Buckinghamshire, MK12 5PT.

NEFF WARRANTIES

From time to time, NEFF may present additional warranties on either products or defined components of a product which are time limited offers. To check if your product qualifies, or to see the full list of warranty options, please visit our website at: neff-home.com/uk/service/warranty



2 Years Warranty

All NEFF home appliances come complete with a 2 years warranty as standard to protect against any manufacturing or material faults during this period.



5 Years Warranty

For a limited time only, selected NEFF home appliances come with a free 5 years warranty. Offer applies to selected NEFF models purchased between 01.04.26 - 31.03.27 and registered within 3 months of purchase.



Lifetime Aqua Stop Warranty

This lifetime warranty protects against water damage caused by a defective Aqua Stop system. Valid on all NEFF washing machines and NEFF dishwashers with an Aqua Stop system.



10 Years Anti-Rust Warranty

This 10 years warranty protects against rust in the inner cavity of NEFF dishwashers. Valid on all NEFF dishwashers purchased from 01.01.2012 onwards.



10 Years Compressor Drive® Motor Warranty

This 10 years warranty covers the Compressor Drive® motor only on selected NEFF refrigeration appliances.



10 Years Silent Drive Warranty



This 10 years warranty protects the motor on your washing machine, ensuring it runs as efficiently as possible.

Register my appliance

REGISTER AND WARRANTY REGISTER YOUR 2 AND 5 YEAR WARRANTY

- Quick access to customer service and support.
- Convenient access to your warranty certificate.
- Enjoy exclusive online offers when you opt in.
- Stay on top of safety updates for your appliance.

REGISTER YOUR 2 YEAR WARRANTY BY TELEPHONE*

 **0800 519 2116**
 **(01) 230 0344**

*Calls are handled by our registration partner Domestic & General.

REGISTER YOUR 5 YEAR WARRANTY WITH US:

UK



IRELAND



ACCESSORIES AND CLEANING PRODUCTS

You can find everything you need for any appliance on the NEFF online store. It's here where you'll find our tested and approved cleaning and care products, along with other accessories ranging from a Glass Holder for your new dishwasher to a Teppan Yaki for your hob, or a new set of Telescopic Rails.

For UK visit:
neff-home.com/uk/store
For IE: Telephone shop available, please call*: (01) 450 2655

SUPPORT AND PRODUCT ADVICE

Prefer to go online? You can visit our support content at: neff-home.com/uk/service/support to quickly find the help you need. We cover questions about usage and maintenance of your appliance, as well as tips on getting started and installing your new appliances. You'll also be able to access your user manual at any time.

GENUINE NEFF SPARE PARTS

NEFF keeps a comprehensive range of replacement spare parts for up to 15* years. You can browse our exploded view diagrams on our store or speak to an advisor on the phone to help you locate and buy the spare parts you need.

For UK visit: neff-home.com/uk/service/spare-parts
For IE visit: neff-home.com/ie/service/care-protection-parts

*As functionally relevant and storable for NEFF home appliances manufactured after 1st January 2023



 **4.7**
Reviews 12,635
Score as of February 2026

NEFF REPAIR SERVICE

NEFF is recognised by Trust Pilot reviews as an excellent service care provider. NEFF home appliances are built to the highest standard, but if you do need a visit from a NEFF engineer, we are here to help. Our locally based engineers are employed and trained by NEFF, which gives them unrivaled knowledge and expertise to repair NEFF appliances.

In some areas we may use an approved service partner to carry out repairs on our NEFF appliances, where the repair process may vary.

You can easily book and manage your engineer visit online.
For UK visit: neff-home.com/uk/service/repair-service
For IE visit: neff-home.com/ie/service/repair-service



NEFF Customer Service
Grand Union House
Old Wolverton Road
Milton Keynes
Buckinghamshire
MK12 5ZR

BSH Home Appliances Ltd.
M50 business Park
Ballymount
Dublin 12
T 1890 626 041
www.neff-home.com/ie

NEFF, a division of
BSH Home Appliances Ltd.
Grand Union House
Old Wolverton Road
Wolverton
Milton Keynes
MK12 5PT
www.neff-home.com/uk

